

ROTORS AND TUBES

For Beckman Coulter
J2, J6, and
Avanti® J Series Centrifuges

User's Manual

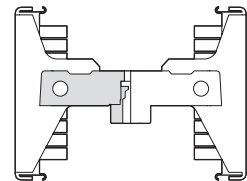

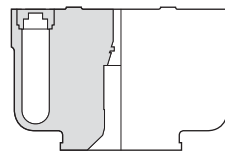
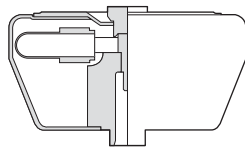
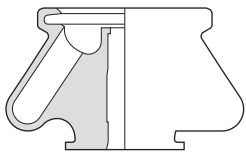

SAFETY NOTICE

This safety notice summarizes information basic to the safe operation of the rotors and accessories described in this manual. The international symbol displayed above is a reminder that all safety instructions should be read and understood before use or maintenance of rotors or accessories. When you see the symbol on other pages, pay special attention to the safety information presented. Also observe any safety information contained in applicable rotor and centrifuge manuals. Observance of safety precautions will help to avoid actions that could cause personal injury, as well as damage or adversely affect the performance of the centrifuge/rotor/tube system.

Chemical and Biological Safety

Normal operation may involve the use of solutions and test samples that are pathogenic, toxic, or radioactive. Such materials should not be used in these rotors, however, unless *all necessary safety precautions are taken*.

- Observe all cautionary information printed on the original solution containers prior to their use.
- Handle body fluids with care because they can transmit disease. No known test offers complete assurance that they are free of micro-organisms. Some of the most virulent—Hepatitis (B and C) and HIV (I–V) viruses, atypical mycobacteria, and certain systemic fungi—further emphasize the need for aerosol protection. Handle other infectious samples according to good laboratory procedures and methods to prevent spread of disease. Because spills may generate aerosols, observe proper safety precautions for aerosol containment. Do not run toxic, pathogenic, or radioactive materials in the rotor without taking appropriate safety precautions. Biosafe containment should be used when Risk Group II materials (as identified in the World Health Organization *Laboratory Biosafety Manual*) are handled; materials of a higher group require more than one level of protection.
- Dispose of all waste solutions according to appropriate environmental health and safety guidelines.
- If disassembly reveals evidence of leakage, you should assume that some fluid escaped the container or rotor. Apply appropriate decontamination procedures to the centrifuge, rotor, and accessories.

Mechanical Safety

- Use only the rotors, components, and accessories designed for use in the rotor and centrifuge being used (refer to the applicable rotor manual). *The safety of rotor components and accessories made by other manufacturers cannot be ascertained by Beckman Coulter. Use of other manufacturers' components or accessories in Beckman Coulter rotors may void the rotor warranty and should be prohibited by your laboratory safety officer.*
- Rotors are designed for use at the speeds indicated; however, speed reductions may be required because of weight considerations of tubes, adapters, and/or the density of the solution being centrifuged. Be sure to observe the instructions in the applicable rotor manual.
- NEVER attempt to slow or stop a rotor by hand.
- The strength of containers can vary between lots, and will depend on handling and usage. We highly recommend that you pretest them in the rotor (using buffer or gradient of equivalent density to the intended sample solution) to determine optimal operating conditions. Scratches (even microscopic ones) significantly weaken glass and polycarbonate containers.

To help prevent premature failures or hazards by detecting stress corrosion, metal fatigue, wear or damage to anodized coatings, and to instruct laboratory personnel in the proper care of rotors, Beckman Coulter offers the Field Rotor Inspection Program (FRIP). This program involves a visit to your laboratory by a specially trained Beckman Coulter representative, who will inspect all of your rotors for corrosion or damage. The representative will recommend repair or replacement of at-risk rotors to prevent potential rotor failures. Contact your local Beckman Coulter office to request this service.

It is your responsibility to decontaminate the rotors and accessories before requesting service by Beckman Coulter Field Service.

ROTORS AND TUBES

For Beckman Coulter
J2, J6, and
Avanti® J Series Centrifuges

User's Manual

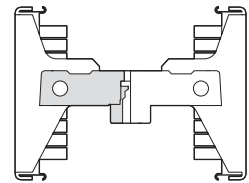
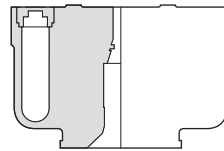
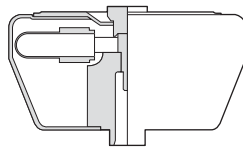
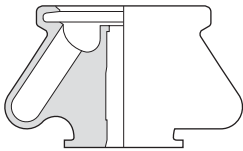

SCOPE OF THIS MANUAL

This manual contains general information for properly preparing a rotor for centrifugation in a Beckman Coulter J series centrifuge. This manual should be used with the individual rotor instruction manual shipped with each rotor. The rotor manuals provide specific information for each rotor, including special operating procedures and precautions, tube, bottle, and adapter part numbers, and equations to calculate maximum allowable rotor speeds. Each manual has a code number in the upper right-hand corner of the cover page that can be used for reordering. To reorder, contact customer service at 1-800-742-2345 in the United States; outside the U.S., contact your local Beckman Coulter representative.

A lot of information is compiled in this manual, and we urge you to read it carefully—especially if this is your first experience with Beckman Coulter products.

- Section 1 describes, by usage, Beckman Coulter’s currently produced J series rotors; this should help you determine the appropriate rotor to use for a particular application. Also included in this section is a discussion of rotor materials, components, and centrifugation techniques.
- Section 2 describes various tubes, adapters, spacers, and cannisters to help you choose a particular container for your application.
- Section 3 provides instructions for using tubes, bottles, cannisters, and related accessories.
- Section 4 contains step-by-step procedures for preparing a fixed angle rotor for a centrifuge run. Similar information is available for swinging bucket rotors in Section 5, and Section 6 contains the same type of information for vertical tube and rack-type rotors. (Elutriation, zonal, and continuous flow rotors are not covered in this manual.)
- Section 7 provides rotor, tube, and accessory care and maintenance information, as well as some diagnostic hints. Please read it. Proper rotor care results in longer rotor life.
- Several appendixes contain information that may be of special interest:
 - Appendix A lists chemical resistances for rotor and accessory materials to help determine compatibility with a variety of solutions.
 - Appendix B contains Temperature Compensation Tables for various rotors.
 - Appendix C contains reference information on some commonly used gradient materials.
 - Appendix D provides information about separation of blood components using J series centrifuges.
 - Appendix E provides a glossary of terms.
 - Appendix F lists references for further reading.

Scope of this Manual

SECTION 1: ROTORS

| | |
|---|------|
| General Description | 1-1 |
| Rotor Designations | 1-1 |
| Materials | 1-3 |
| Drive Pins | 1-4 |
| Rotor Selection | 1-5 |
| Pelleting (Differential Separation) | 1-11 |
| Isopycnic Separations | 1-14 |
| Rate Zonal Separations | 1-15 |
| Blood Component Separations | 1-16 |
| General Operating Information | 1-16 |
| Rotor Balance | 1-16 |
| Rotor Tie-down | 1-17 |
| Overspeed Protection | 1-18 |
| Allowable Run Speeds | 1-19 |
| Temperature Compensation | 1-20 |

SECTION 2: TUBES, BOTTLES, AND ACCESSORIES

| | |
|---|-----|
| Labware Selection Criteria | 2-1 |
| Labware Material Compatibility with Solvents and Sample | 2-3 |
| Gradient Formation and Fractionation | 2-3 |

| | Page |
|---|------|
| Labware Types | 2-3 |
| Polyallomer Tubes | 2-4 |
| Polycarbonate Tubes | 2-5 |
| Polypropylene Tubes | 2-5 |
| Polyethylene Tubes | 2-5 |
| Ultra-Clear Tubes | 2-6 |
| Stainless Steel Tubes | 2-6 |
| Microfuge [®] Tubes | 2-6 |
| Bottles | 2-7 |
| Multiwell Titer Plates | 2-7 |
| Temperature Limits | 2-8 |
| Spacers and Floating Spacers | 2-9 |
| Adapters | 2-9 |
| Bottle Adapters | 2-9 |
| Multitube Adapters | 2-10 |
| Bottle and Tube Caps | 2-11 |
| Aerosolve [™] Cannisters | 2-12 |
| Blood Bag Cups | 2-12 |
| Rotor Labware Assemblies | 2-13 |

SECTION 3: USING TUBES, BOTTLES, AND ACCESSORIES

| | |
|---|-----|
| Gradient Preparation | 3-1 |
| General Filling and Sealing or Capping Requirements | 3-2 |
| Working with Physiological Fluids | 3-4 |
| Filling Open-Top Tubes | 3-5 |
| Open-Top Polyallomer Tubes | 3-5 |
| Other Open-Top Tubes | 3-5 |
| Capping Tubes | 3-7 |

| | Page |
|---|------|
| Filling and Capping Bottles | 3-7 |
| Three-Piece Cap Assemblies | 3-8 |
| JLA-8.1000 and JLA-9.1000 Bottle Cap/Closures | 3-8 |
| Filling and Loading Cups in the JS-5.0 Rotor | 3-8 |
| Filling and Sealing Quick-Seal Tubes | 3-9 |
| Method A — With the Seal Guide | 3-12 |
| Method B — Without the Seal Guide | 3-13 |
| Capping Multiwell Titer Plates | 3-14 |
| Using Adapters | 3-14 |
| Using Solid Multitube Adapters | 3-15 |
| Using Modular Disk Multitube Adapters | 3-15 |
| Using Aerosolve Cannisters | 3-16 |
| Using Cannisters as Wide-Mouth Bottles | 3-17 |
| Using Cannisters with Tube Racks | 3-17 |
| Using Blood Bag Cups | 3-18 |
| Sample Recovery | 3-19 |
| Capped Tubes | 3-20 |
| JS-5.0 Cups | 3-20 |
| Quick-Seal Tubes | 3-21 |
| Making Ultra-Clear Tubes Wettable | 3-22 |

SECTION 4: USING FIXED ANGLE ROTORS

| | |
|---|------|
| Description | 4-1 |
| Tubes and Bottles | 4-7 |
| Rotor Preparation and Loading | 4-8 |
| Prerun Safety Checks | 4-8 |
| Rotor Preparation | 4-8 |
| Operation | 4-9 |
| Installing the Rotor | 4-9 |
| Removal and Sample Recovery | 4-10 |

SECTION 5: USING SWINGING BUCKET ROTORS

| | |
|---------------------------------------|------|
| Description | 5-1 |
| Labware | 5-5 |
| Rotor Preparation and Loading | 5-5 |
| Prerun Safety Checks | 5-5 |
| Rotor Preparation | 5-6 |
| Loading the Rotor Yoke | 5-7 |
| Symmetric and Balanced Loading | 5-8 |
| Loading Buckets | 5-11 |
| Loading Buckets into the Rotor | 5-13 |
| Using Microtiter Plate Carriers | 5-14 |
| Operation | 5-16 |
| Sample Recovery | 5-17 |

SECTION 6: USING VERTICAL TUBE AND RACK-TYPE ROTORS

| | |
|-------------------------------------|------|
| Description | 6-1 |
| Vertical Tube Rotors | 6-1 |
| Rack-Type Rotors | 6-2 |
| Using a Vertical Tube Rotor | 6-3 |
| Tubes and Bottles | 6-3 |
| Rotor Preparation and Loading | 6-4 |
| Operation | 6-5 |
| Installing the Rotor | 6-5 |
| Removal and Sample Recovery | 6-6 |
| Using a Rack-Type Rotor | 6-7 |
| Trays and Tubes | 6-7 |
| Rotor Preparation and Loading | 6-7 |
| Operation | 6-8 |
| Installing the Rotor | 6-9 |
| Removal and Sample Recovery | 6-10 |

SECTION 7: CARE AND MAINTENANCE

| | |
|---|------------|
| Rotor Care | 7-1 |
| Cleaning | 7-2 |
| Decontamination | 7-3 |
| Sterilization and Disinfection | 7-4 |
| Inspection | 7-4 |
| Lubrication | 7-5 |
| Field Rotor Inspection Program | 7-6 |
| Tube, Bottle, and Accessory Care | 7-7 |
| Cleaning | 7-7 |
| Decontamination | 7-7 |
| Sterilization and Disinfection | 7-8 |
| Inspection | 7-10 |
| Tube and Bottle Storage | 7-10 |
| Returning a Rotor or Accessory to the Factory | 7-11 |
| Diagnostic Hints | 7-12 |
| | |
| Appendix A: Chemical Resistances for Beckman Coulter Centrifugation Products | A-1 |
| | |
| Appendix B: Temperature Compensation Tables | B-1 |
| | |
| Appendix C: Gradient Materials | C-1 |
| | |
| Appendix D: Blood Component Separation | D-1 |
| | |
| Appendix E: Glossary of Terms | E-1 |
| | |
| Appendix F: References | F-1 |
| | |
| Warranty | |

| | Page |
|--|------|
| Figure 1-1. Fixed Angle, Swinging Bucket, Vertical Tube, and Rack-Type Rotors | 1-2 |
| Figure 1-2. Particle Separation in Fixed Angle, Swinging Bucket, and Vertical Tube Rotors. | 1-10 |
| Figure 1-3. Sedimentation Coefficients (in Svedberg Units) for Some Common Biological Materials | 1-12 |
| Figure 1-4. Nomogram for J2 Series Centrifuges | 1-13 |
| Figure 1-5. Nomogram for J6 Series Centrifuges | 1-14 |
| Figure 1-6. Arranging Tubes Symmetrically in a Fixed Angle, Vertical Tube, or JS-24 Series Swinging Bucket Rotor | 1-17 |
| | |
| Figure 3-1. The Cordless Quick-Seal Tube Topper | 3-10 |
| | |
| Figure 4-1. Examples of Fixed Angle Rotors | 4-2 |
| | |
| Figure 5-1. Examples of Swinging Bucket Rotors | 5-2 |
| Figure 5-2. Examples of Correctly and Incorrectly Loaded Buckets and Carriers. | 5-9 |
| Figure 5-3. Typical Blood Bag Loading Procedure (JS-4.3 Rotor Shown) | 5-12 |
| Figure 5-4. The Micro Plus Microtiter Plate Carrier, Base, Pad, and Deep-Well Microtiter Plate. | 5-15 |
| | |
| Figure 6-1. Vertical Tube Rotor | 6-2 |
| Figure 6-2. Rack-Type Rotor. | 6-3 |
| | |
| Figure D-1. Blood Component Preparation | D-5 |

| | Page |
|--|------|
| Table 1-1. Rotors Used in Beckman Coulter J Series Centrifuges | 1-5 |
| Table 2-1. Characteristics and Chemical Resistances of Tube and Bottle Materials. | 2-2 |
| Table 3-1. General Filling and Sealing Requirements for Tubes and Bottles | 3-3 |
| Table 3-2. Aerosolve Tube Racks | 3-18 |
| Table 4-1. General Specifications for Beckman Coulter J Series Fixed Angle Rotors. | 4-3 |
| Table 5-1. General Specifications for Beckman Coulter J Series Swinging Bucket Rotors. | 5-3 |
| Table 5-2. Microplate Carriers Used with J6 Series Rotors. | 5-16 |
| Table 6-1. General Specifications for Beckman Coulter J Series Vertical Tube and Rack-Type Rotors. | 6-2 |
| Table 7-1. Tube and Bottle Sterilization and Disinfection. | 7-8 |
| Table B-1. Temperature Compensation Settings for the J2-HC Centrifuge. | B-2 |
| Table B-2. Temperature Compensation Settings for the J2-21, J2-21B, J2-21C, and J2-HS Centrifuges | B-4 |

| | Page |
|---|------|
| Table B-3. Temperature Compensation Settings for the J2-MI, J2-21M, J2-MC, and J2-21M/E Centrifuges | B-6 |
| Table B-4. Temperature Compensation Settings for the J6 Centrifuges | B-8 |
| Table C-1. Commonly Used Gradient Materials with Their Solvents | C-2 |
| Table C-2. Density, Refractive Index, and Concentration Data— Cesium Chloride at 25°C, Molecular Weight = 168.37 | C-3 |
| Table C-3. Density, Refractive Index, and Concentration Data— Sucrose at 20°C, Molecular Weight = 342.3 | C-4 |
| Table C-4. Density Conversion for Cesium and Rubidium Salts at 20°C | C-5 |
| Table D-1. Blood Component Storage | D-3 |
| Table D-2. Blood Bank Methods | D-5 |

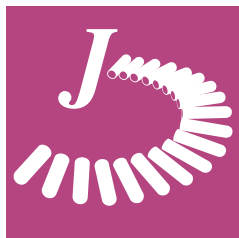

This section is an introduction to the Beckman Coulter family of J series rotors, providing general information on rotor design, selection, and operation. Rotor designs described are fixed angle, swinging bucket, vertical tube, and rack type. Specific instructions for using each type of rotor are contained in Sections 4 through 6. Care and maintenance information for all of these rotors is contained in Section 7. Elutriator, continuous flow, and zonal rotors are not covered in this manual. The elutriator rotors are described in detail in their respective rotor instruction manuals, publications JE6B-IM and JE5-IM; the continuous flow/zonal rotor, JCF-Z, is described in publication JCFZ-IM.

GENERAL DESCRIPTION

ROTOR DESIGNATIONS

Beckman Coulter J series rotors are usually named according to the type of rotor and the rotor's maximum allowable revolutions per minute (in thousands), referred to as rated speed. For example, the JA-12 rotor is a fixed angle rotor with a maximum speed of 12 000 rpm. However, the naming system for J series rotors was changed slightly in early 1994.

- Rotors released *before 1994* (for example, the JA-18.1): JA designates that it is a fixed angle rotor used in a J series centrifuge; the 18 indicates that the rated speed of the rotor is 18 000 rpm; the decimal unit (.1) distinguishes between different rotors with the same rated speed.
- Rotors released *after January 1994* (for example, the JA-25.50): JA still designates that it is a fixed angle rotor used in a J series centrifuge; the 25 still identifies the rated speed of the rotor (25 000 rpm); but the decimal unit (.50) describes the nominal volume of the largest tube or bottle (in mL) used in the rotor.

An example of each rotor type is shown in Figure 1-1.

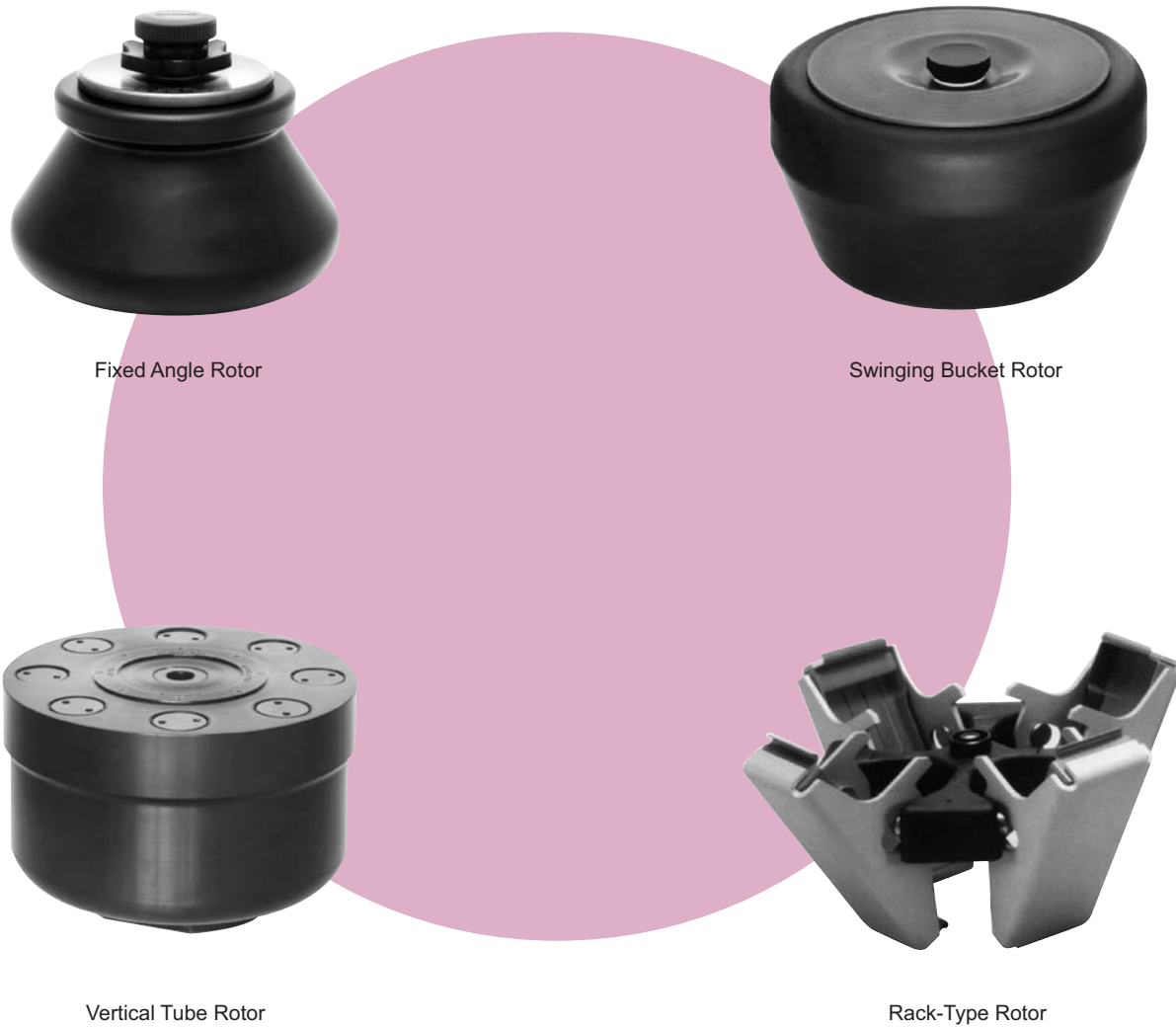

Figure 1-1. Fixed Angle, Swinging Bucket, Vertical Tube, and Rack-Type Rotors

Containers in *fixed angle rotors* (designated **JA**) are held at an angle to the axis of rotation in tube cavities.

Containers in *J-Lite™ fixed angle rotors* (designated **JLA**) are also held at an angle to the axis of rotation; the rotor construction results in reduced overall weight.

Containers in *swinging bucket rotors* (designated **JS**) are held in rotor buckets or multitube carriers attached to the rotor body by hinge pins. The buckets or carriers swing out to a horizontal position as the rotor accelerates.

Tubes in *vertical tube rotors* (designated **JV**) are held parallel to the axis of rotation. These rotors have plugs, screwed into the rotor cavities over sealed tubes, that keep the tubes in the cavities and provide support for the hydrostatic forces generated by centrifugation.

Tubes in the *rack-type rotor* (designated **JR**) are held in gamma-counter racks. Racks are loaded into special plastic trays, which are then loaded into carriers at a resting angle. During centrifugation, the carriers swing out to a completely horizontal position.

MATERIALS

Most Beckman Coulter J series rotors are made of aluminum and are anodized to protect the metal from corrosion. (The JS-13.1 and JS-7.5 rotors are painted with polyurethane paint and are not anodized.) The anodized coating is a thin, hard layer of aluminum oxide formed electrochemically in the final stages of rotor fabrication. A black or colored dye may be applied over the oxide for rotor family identification. The coating can be damaged if careful cleaning procedures are not followed. Therefore, it is especially important to clean aluminum rotors with brushes that will not scratch the anodized coating and to use a noncorrosive, neutral-pH detergent. Refer to Section 7 for cleaning and maintenance procedures.

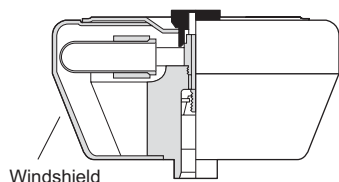

Some J series rotors have attached windshields to reduce air friction. The windshields are made of anodized aluminum.

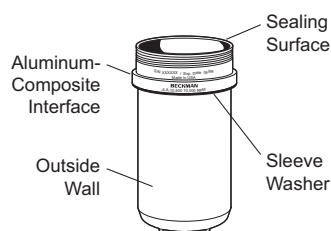

Cannisters used in some J-Lite rotors are made of lightweight carbon fiber epoxy composite. The lightweight cannisters make the overall rotor weight significantly lighter than a comparably sized all-aluminum rotor. Each cannister has a sleeve washer, made of Teflon¹ and Ultem,² which acts as a sleeve between the cannister and the aluminum rotor body. A lubricated ethylene propylene rubber O-ring inside the cannister closure helps create a secondary seal during centrifugation.

¹ Teflon is a registered trademark of E.I. Du Pont de Nemours & Company.

² Ultem is a registered trademark of GE Plastics.

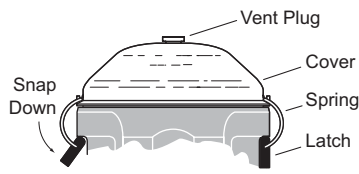

Transparent plastic covers are available for some swinging bucket rotor buckets, to help contain spills and glass particles in the event of tube breakage. The covers are made of high-impact Ultem. Each cover requires an O-ring.

The O-rings or gaskets in rotor assemblies with lids are made of Buna N elastomer and maintain atmospheric pressure in the rotor if they are kept clean and lightly coated with silicone vacuum grease. Plug gaskets in vertical tube rotors are made of Hytrel³ and do not require coating.

DRIVE PINS

Currently produced J series rotors have drive pins in the drive hole. These pins mesh with teeth on the centrifuge drive spindle hub when the rotor is installed to ensure that the rotor does not slip on the hub during initial acceleration. Most drive pins are oriented horizontally (or angled) in the drive hole; however, some are oriented vertically.

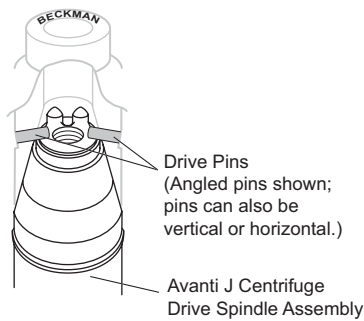

All rotors used in Avanti J series centrifuges must have drive pins in the rotor drive hole. Some Beckman Coulter rotors, including the JA-10 and the JS-7.5, were previously manufactured without drive pins because pins were not needed when these rotors were used in J2 series centrifuges. *Check all J series rotors for drive pins before using them in an Avanti J series centrifuge.* To check for drive pins, hold the rotor up or turn it on its side and look into the drive hole. If you do not see two metal pins near the top of the hole, do not use the rotor in the Avanti J. Call your local Beckman Coulter office for information on returning the rotor to the factory for upgrading.

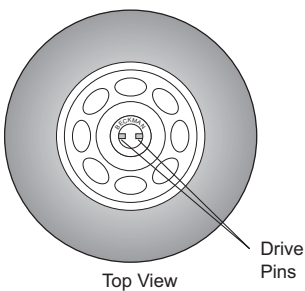

In fixed angle and vertical tube rotors manufactured since early 1997, the rotor pins are positioned parallel to the BECKMAN name engraved at the center of the rotor body. Knowing the pin orientation before you install the rotor will help to ensure that you position the rotor properly on the hub, minimizing the chance of hub damage.

³ Hytrel is a registered trademark of E.I. Du Pont de Nemours & Company.

ROTOR SELECTION

Rotors used in Beckman Coulter J series centrifuges are listed in Table 1-1. General rotor specifications for each fixed angle rotor are in Table 4-1, swinging buckets in Table 5-1, and vertical tube and rack-type in Table 6-1. Detailed descriptions of each rotor are included in the applicable rotor manual.

*Table 1-1. Rotors Used in Beckman Coulter J Series Centrifuges.
Rotors and centrifuges in parentheses are no longer manufactured.*

| Rotor | Nominal Rotor Capacity | Max Speed (rpm) | Max RCF (× g) | k Factor | Avanti J-30 I | (Avanti J-25 Series) | Avanti J-26XP Series | (Avanti J-20 Series) | Avanti J-E | Avanti J-HC | (J2-MC) | (J2-HS) | (J2-HC) | J6-MI | (J6-MC) | (J6-HC) |
|--------------------------------|------------------------|---------------------|--|----------------|---------------|----------------------|----------------------|----------------------|------------|-------------|---------|---------|---------|-------|---------|---------|
| Fixed Angle | | | | | | | | | | | | | | | | |
| JA-30.50 Ti | 400 mL | 30 000 | 108 860 | 280 | X | X | X | X | | | X | X | X | | | |
| JA-25.50 | 400 mL | 25 000 | 76 600 ^a | 418 | X | X | X | X | X | | X | X | X | | | |
| JA-25.15 | 360 mL | 25 000 | 74 200 (outer row) 60 200 (inner row) | 265 380 | X | X | X | X | | | X | X | X | | | |
| JA-21 | 180 mL | 21 000 | 50 400 | 470 | X | X | X | X | X | | X | X | X | X | X | X |
| JA-20.1 | 480 mL | 20 000 | 51 500 (outer row) 43 900 (inner row) | 325 371 | X | X | X | X | X | | X | X | X | X | X | X |
| JA-20 | 400 mL | 20 000 | 48 400 | 770 | X | X | X | X | X | | X | X | X | X | X | X |
| JA-18.1 (45° angle adapter) | 43.2 mL | 18 000 ^b | 42 100 | 156 | X | X | X | X | | | X | X | X | X | X | X |

Continued —

^a Maximum speed in an Avanti J-E centrifuge is 21 000 rpm (18 000 rpm at 2°C at 35°C ambient and 95 percent humidity).

^b When a JA-18.1 rotor is used in a J2-HC centrifuge, derate the rotor as follows: when the 45° adapters are used, do not run the rotor above 15 000 rpm; when 25° adapters are used, do not run the rotor above 16 000 rpm.

^c Maximum speed in an Avanti J-E for the rotor with magnets; without magnets maximum is 14 000 rpm. (Maximum speed at 2°C in a 50-Hz centrifuge is 14 000 rpm.)

^d Maximum speed in an Avanti J-E for the rotor with magnets; without magnets maximum is 13 000 rpm. (Maximum speed at 2°C in a 50-Hz centrifuge is 15 000 rpm.)

^e Maximum speed in an Avanti J series centrifuge. Maximum speed in a J2 series centrifuge is 14 000 rpm.

^f Newer JA-10 rotors with magnets, p/n 369867, cannot be used in J2 or J6 series centrifuges. Older JA-10 rotors without magnets, p/n 334833, can be used in J2 and J6 series centrifuges.

^g Maximum speed in an Avanti J-E for rotor without magnets is 6 300 rpm.

^h Maximum speed for rotor in an Avanti J-E centrifuge is 6 300 rpm.

ⁱ The JS-24.38 and JS-24.15 rotors can achieve 24 000 rpm in an Avanti J-30 I centrifuge only. In Avanti J-26XP series, J-25 series, and J-20 series centrifuges, the maximum speed for these rotors is 10 000 rpm.

Table 1-1. Rotors Used in Beckman Coulter J Series Centrifuges (continued).
Rotors and centrifuges in parentheses are no longer manufactured.

| Rotor | Nominal Rotor Capacity | Max Speed (rpm) | Max RCF ($\times g$) | k Factor | Avanti J-30 I | (Avanti J-25 Series) | Avanti J-26XP Series | (Avanti J-20 Series) | Avanti J-E | Avanti J-HC | (J2-MC) | (J2-HS) | (J2-HC) | J6-MI | (J6-MC) | (J6-HC) |
|--------------------------------|------------------------|---------------------|------------------------|------------|---------------|----------------------|----------------------|----------------------|------------|-------------|---------|---------|---------|-------|---------|---------|
| Fixed Angle (continued) | | | | | | | | | | | | | | | | |
| JA-18.1 (25° angle adapter) | 43.2 mL | 17 000 ^b | 36 300 | 91 | X | X | X | X | X | | | X | X | X | X | X |
| JA-17 | 700 mL | 17 000 ^d | 39 800 | 690 | X | X | X | X | X | | X | X | X | X | X | X |
| JLA-16.250 | 1.5 liter | 16 000 ^e | 38 400 | 1 090 | X | X | X | X | X | | X | X | | | | |
| JA-14 | 1.5 liter | 14 000 | 30 100 | 1 764 | X | X | X | X | X | | X | X | X | X | X | X |
| F14BCI-14x50cy | 700 mL | 14 000 | 33 500 | 789 | X | X | X | X | X | | | | | | | |
| F14BCI-6x250y | 1 500 mL | 14 000 | 30 000 | 1 690 | X | X | X | X | X | | | | | | | |
| JA-12 | 600 mL | 12 000 | 23 200 | 1 244 | X | X | X | X | X | | X | X | X | | | |
| JA-10 ^f | 3 liters | 10 000 ^g | 17 700 | 3 610 | X | X | X | X | X | X | X | X | X | X | X | X |
| JLA-10.500 | 3 liters | 10 000 ^g | 18 500 | 2 850 | X | X | X | X | X | | X | X | X | | | |
| F10BCI-6x500y | 3 liters | 10 000 | 17 696 | 3 417 | X | X | X | X | X | | | | | | | |
| JLA-9.1000 | 4 liters | 9 000 ^h | 16 800 | 2 540 | X | X | X | X | X | | | | | | | |
| JLA-8.1000 | 6 liters | 8 000 | 15 900 | 2 500 | | | X | X | | X | | | | | | |

Continued —

^a Maximum speed in an Avanti J-E centrifuge is 21 000 rpm (18 000 rpm at 2°C at 35°C ambient and 95 percent humidity).

^b When a JA-18.1 rotor is used in a J2-HC centrifuge, derate the rotor as follows: when the 45° adapters are used, do not run the rotor above 15 000 rpm; when 25° adapters are used, do not run the rotor above 16 000 rpm.

^c Maximum speed in an Avanti J-E for the rotor with magnets; without magnets maximum is 14 000 rpm. (Maximum speed at 2°C in a 50-Hz centrifuge is 14 000 rpm.)

^d Maximum speed in an Avanti J-E for the rotor with magnets; without magnets maximum is 13 000 rpm. (Maximum speed at 2°C in a 50-Hz centrifuge is 15 000 rpm.)

^e Maximum speed in an Avanti J series centrifuge. Maximum speed in a J2 series centrifuge is 14 000 rpm.

^f Newer JA-10 rotors with magnets, p/n 369867, cannot be used in J2 or J6 series centrifuges. Older JA-10 rotors without magnets, p/n 334833, can be used in J2 and J6 series centrifuges.

^g Maximum speed in an Avanti J-E for rotor without magnets is 6 300 rpm.

^h Maximum speed for rotor in an Avanti J-E centrifuge is 6 300 rpm.

ⁱ The JS-24.38 and JS-24.15 rotors can achieve 24 000 rpm in an Avanti J-30 I centrifuge only. In Avanti J-26XP series, J-25 series, and J-20 series centrifuges, the maximum speed for these rotors is 10 000 rpm.

Table 1-1. Rotors Used in Beckman Coulter J Series Centrifuges (continued).
Rotors and centrifuges in parentheses are no longer manufactured.

| Rotor | Nominal Rotor Capacity | Max Speed (rpm) | Max RCF ($\times g$) | k Factor | Avanti J-30 I | (Avanti J-25 Series) | Avanti J-26XP Series | (Avanti J-20 Series) | Avanti J-E | Avanti J-HC | (J2-MC) | (J2-HS) | (J2-HC) | J6-MI | (J6-MC) | (J6-HC) |
|-----------------|------------------------|---------------------|------------------------|----------|---------------|----------------------|----------------------|----------------------|------------|-------------|---------|---------|---------|-------|---------|---------|
| Swinging Bucket | | | | | | | | | | | | | | | | |
| JS-24.38 | 231 mL | 24 000 ⁱ | 103 900 | 334 | X | X | X | X | | | | | | | | |
| JS-24.15 | 90 mL | 24 000 ⁱ | 110 500 | 376 | X | X | X | X | | | | | | | | |
| JS-13.1 | 300 mL | 13 000 | 26 500 | 1 841 | X | X | X | X | X | | X | X | X | X | X | X |
| JS-7.5 | 200 mL | 7 500 | 10 400 | 1 090 | X | X | X | X | | | X | X | X | X | X | X |
| JS-5.9 | 384 mL | 5 900 | 6 570 | | X | X | | | | | | | | | | |
| JS-5.3 | 691 mL | 5 300 | 6 130 | | | | X | X | X | | | | | | | |
| JS-5.2 | 4 liters | 5 200 | 6 840 | 9 051 | | | | | | | | | | | X | X |
| JS-5.0 | 9 liters | 5 000 | 7 480 | 9 171 | | | | | | X | | | | | | |
| JS-4.3 | 3 liters | 4 300 | 4 220 | 16 635 | | | X | X | | | | | X | | | |
| JS-4.2 | 6 liters | 4 200 | 5 020 | 11 502 | | | | | | X | | | X | X | X | X |
| JS-4.2A | 6 liters | 4 200 | 5 020 | 11 502 | | | | | | X | | | | X | X | X |
| JS-4.2SM | 6 quad blood bags | 4 200 | 4 900 | | | | | | | | | | | X | X | X |
| JS-4.2SMA | 6 quad blood bags | 4 200 | 4 900 | | | | | | | | | | | X | X | X |
| JS-4.0 | 4 liters | 4 000 | 4 050 | 15 298 | | | X | X | | | | | | X | X | X |
| (JS-3.4A-1250) | 7.5 liters | 3 400 | 3 370 | 18 066 | | | | | | X | | | | | | |
| JS-3.0 | 6 liters | 3 000 | 2 560 | 22 598 | | | | | | | | | | X | X | X |
| (JS-2.9) | 6 liters | 2 900 | 2 500 | 24 400 | | | | | | | | | | X | X | X |

Continued —

^a Maximum speed in an Avanti J-E centrifuge is 21 000 rpm (18 000 rpm at 2°C at 35°C ambient and 95 percent humidity).

^b When a JA-18.1 rotor is used in a J2-HC centrifuge, derate the rotor as follows: when the 45° adapters are used, do not run the rotor above 15 000 rpm; when 25° adapters are used, do not run the rotor above 16 000 rpm.

^c Maximum speed in an Avanti J-E for the rotor with magnets; without magnets maximum is 14 000 rpm. (Maximum speed at 2°C in a 50-Hz centrifuge is 14 000 rpm.)

^d Maximum speed in an Avanti J-E for the rotor with magnets; without magnets maximum is 13 000 rpm. (Maximum speed at 2°C in a 50-Hz centrifuge is 15 000 rpm.)

^e Maximum speed in an Avanti J series centrifuge. Maximum speed in a J2 series centrifuge is 14 000 rpm.

^f Newer JA-10 rotors with magnets, p/n 369867, cannot be used in J2 or J6 series centrifuges. Older JA-10 rotors without magnets, p/n 334833, can be used in J2 and J6 series centrifuges.

^g Maximum speed in an Avanti J-E for rotor without magnets is 6 300 rpm.

^h Maximum speed for rotor in an Avanti J-E centrifuge is 6 300 rpm.

ⁱ The JS-24.38 and JS-24.15 rotors can achieve 24 000 rpm in an Avanti J-30 I centrifuge only. In Avanti J-26XP series, J-25 series, and J-20 series centrifuges, the maximum speed for these rotors is 10 000 rpm.

Table 1-1. Rotors Used in Beckman Coulter J Series Centrifuges (continued).
Rotors and centrifuges in parentheses are no longer manufactured.

| Rotor | Nominal Rotor Capacity | Max Speed (rpm) | Max RCF ($\times g$) | k Factor | Avanti J-30 I | (Avanti J-25 Series) | Avanti J-26XP Series | (Avanti J-20 Series) | Avanti J-E | Avanti J-HC | (J2-MC) | (J2-HS) | (J2-HC) | J6-MI | (J6-MC) | (J6-HC) |
|---|---|-----------------|------------------------|----------|---------------|----------------------|----------------------|----------------------|------------|-------------|---------|---------|---------|-------|---------|---------|
| Vertical Tube and Rack Type | | | | | | | | | | | | | | | | |
| (JV-20) | 312 mL | 20 000 | 41 619 | 206 | | | | | | | X | X | X | | | |
| JR-3.2 | 320 mL | 3 200 | 2 280 | 25 606 | | | | | | | | | | X | X | X |
| Zonal and Continuous Flow (see applicable rotor manual for rotor description and use) | | | | | | | | | | | | | | | | |
| JCF-Z | 100 L/hr (HF seal assembly) 45 L/hr (SF seal assembly) | 20 000 | 39 900 | | X | X | X | X | | | X | X | X | | | |
| JE-5.0 | 1000 mL | 5 000 | 4 700 | | | | X | X | | | | | | X | X | X |
| JE-6B | 100 mL | 6 000 | 5 080 | | X | X | | | | | X | X | X | | | |

^a Maximum speed in an Avanti J-E centrifuge is 21 000 rpm (18 000 rpm at 2°C at 35°C ambient and 95 percent humidity).

^b When a JA-18.1 rotor is used in a J2-HC centrifuge, derate the rotor as follows: when the 45° adapters are used, do not run the rotor above 15 000 rpm; when 25° adapters are used, do not run the rotor above 16 000 rpm.

^c Maximum speed in an Avanti J-E for the rotor with magnets; without magnets maximum is 14 000 rpm. (Maximum speed at 2°C in a 50-Hz centrifuge is 14 000 rpm.)

^d Maximum speed in an Avanti J-E for the rotor with magnets; without magnets maximum is 13 000 rpm. (Maximum speed at 2°C in a 50-Hz centrifuge is 15 000 rpm.)

^e Maximum speed in an Avanti J series centrifuge. Maximum speed in a J2 series centrifuge is 14 000 rpm.

^f Newer JA-10 rotors with magnets, p/n 369867, cannot be used in J2 or J6 series centrifuges. Older JA-10 rotors without magnets, p/n 334833, can be used in J2 and J6 series centrifuges.

^g Maximum speed in an Avanti J-E for rotor without magnets is 6 300 rpm.

^h Maximum speed for rotor in an Avanti J-E centrifuge is 6 300 rpm.

ⁱ The JS-24.38 and JS-24.15 rotors can achieve 24 000 rpm in an Avanti J-30 I centrifuge only. In Avanti J-26XP series, J-25 series, and J-20 series centrifuges, the maximum speed for these rotors is 10 000 rpm.

Selection of a rotor depends on a variety of factors, such as sample volume, number of sample components to be separated, particle size, run time, required quality of separation, type of separation, and the centrifuge in use. Fixed angle, swinging bucket, vertical tube, and rack-type rotors are designed to provide optimal separations for a variety of sample types. (For especially large sample volumes, continuous flow and zonal rotors are available.)

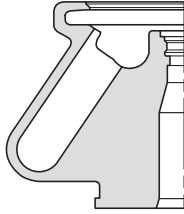

- *Fixed angle rotors* are general-purpose rotors that are especially useful for pelleting subcellular particles and in short-column banding of viruses and subcellular organelles. Tubes are held at an angle (usually 20 to 45 degrees) to the axis of rotation. The tube angle shortens the particle pathlength (see Figure 1-2), compared to swinging bucket rotors, resulting in reduced run times. Tubes can be placed directly in a rotor cavity if the diameters of the tube and the cavity are the same. Using adapters, more than one type and size of tube can be centrifuged together, provided that the loads are properly balanced. Refer to Section 4 for specific information about the use of fixed angle rotors.

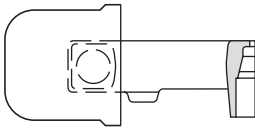

- *Swinging bucket rotors* are used for pelleting, isopycnic studies (separation as a function of density), and rate zonal studies (separation as a function of sedimentation coefficient). Large swinging bucket rotors are used to obtain cell-free plasma or for cell packing. These rotors can be equipped with racks or microplate carriers to hold a variety of tubes, bottles, blood bags, or multiwell plates. Refer to Section 5 for specific information about the use of swinging bucket rotors.

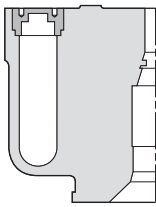

- *Vertical tube rotors* hold tubes parallel to the axis of rotation; therefore, bands separate across the diameter of the tube rather than down the length of the tube (see Figure 1-2). Only Quick-Seal tubes are used in vertical tube rotors, making tube caps unnecessary. Refer to Section 6 for specific information about the use of vertical tube rotors.

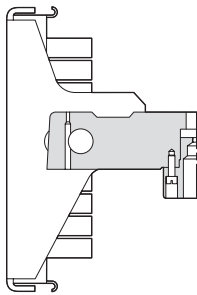

- *Rack-type rotors* hold tubes in gamma-counter racks. Racks are loaded into special plastic trays, which are then loaded into carriers at a resting angle. During centrifugation, the carriers swing out to a completely horizontal position. Refer to Section 6 for specific information about the use of rack-type rotors.

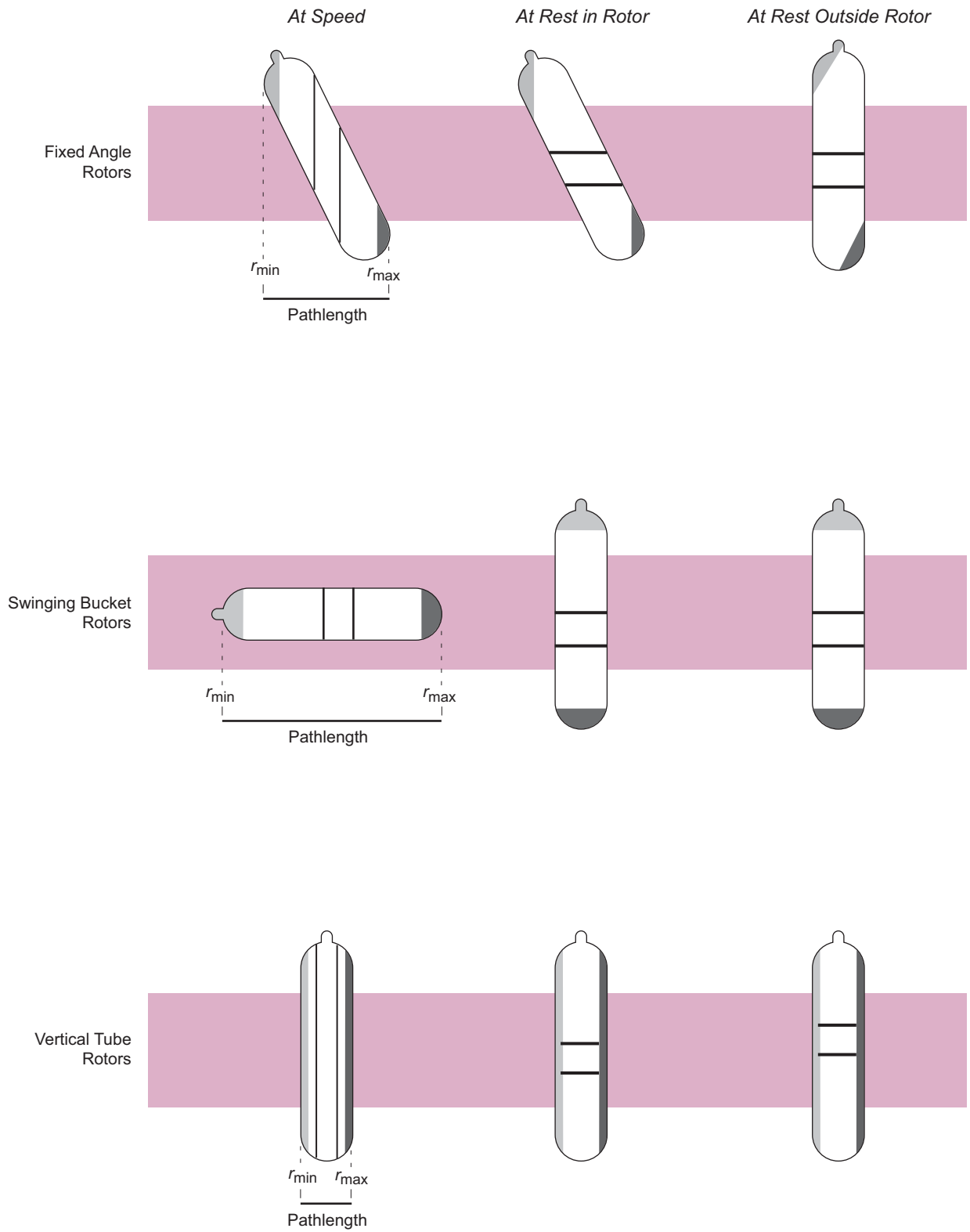

Figure 1-2. Particle Separation in Fixed Angle, Swinging Bucket, and Vertical Tube Rotors. Dark gray represents pelleted material, light gray is floating components, and bands are indicated by black lines.

PELLETING (DIFFERENTIAL SEPARATION)

Pelleting separates particles of different sedimentation coefficients, the largest particles in the sample traveling to the bottom of the tube (or bottle) first. Differential centrifugation is the successive pelleting of particles of decreasing sedimentation velocities, using increasingly higher forces and/or long run times. The relative pelleting efficiency of each rotor is measured by its k factor (clearing factor):

$$k = \frac{\ln(r_{\max}/r_{\min})}{\omega^2} \times \frac{10^{13}}{3600} \quad (1)$$

where ω is the angular velocity of the rotor in radians per second ($2\pi \text{RPM}/60$, or $\omega = 0.10472 \times \text{rpm}$), r_{\max} is the maximum radius, and r_{\min} is the minimum radius.

After substitution,

$$k = \frac{(2.533 \times 10^{11}) \ln(r_{\max}/r_{\min})}{\text{rpm}^2} \quad (2)$$

This factor can be used in the following equation to estimate the time t (in hours) required for pelleting:

$$t = \frac{k}{s} \quad (3)$$

where s is the sedimentation coefficient⁴ of the particle of interest in Svedberg units. (Because s values in seconds are such small numbers, they are generally expressed in Svedberg units (S), where 1 S is equal to 10^{-13} seconds). It is usual practice to use the standard sedimentation coefficient $s_{20,\omega}$ based on sedimentation in water at 20°C. Clearing factors can be calculated at speeds other than maximum rated speed by use of the following formula:

$$k_{\text{adj}} = k \left(\frac{\text{rated speed of rotor}}{\text{actual run speed}} \right)^2 \quad (4)$$

⁴ $s = dr/dt \times 1/\omega^2 r$, where dr/dt is the sedimentation velocity.

Run times can also be calculated from data established in prior experiments when the k factor of the previous rotor is known. For any two rotors, a and b:

$$\frac{t_a}{t_b} = \frac{k_a}{k_b} \tag{5}$$

where the k factors have been adjusted for the actual run speed used.

Figure 1-3 lists sedimentation coefficients for some common biological materials. The k factors at rated speeds for Beckman Coulter J series rotors are provided in the table of general specifications in each rotor use section.

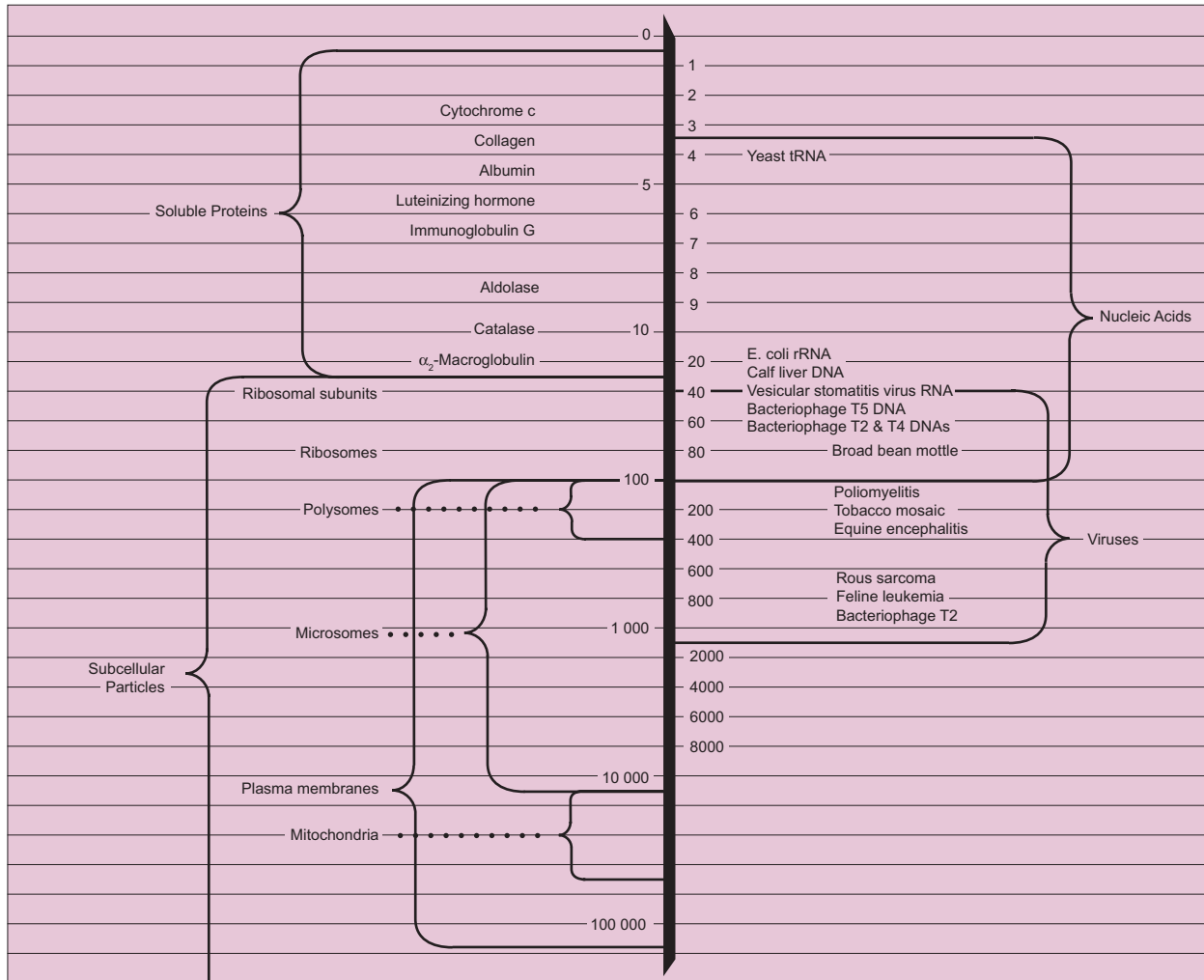

Figure 1-3. Sedimentation Coefficients (in Svedberg Units) for Some Common Biological Materials

The centrifugal force exerted at a given radius in a rotor is a function of the rotor speed. The nomograms for J2 series and J6 series centrifuges in Figures 1-4 and 1-5 allow you to determine relative centrifugal field (RCF) for a given radius and rotor speed. In Avanti J series centrifuges, the RCF is calculated automatically by the centrifuge software.

Run times can be shortened by using partially filled thickwall polyal- lomer and polycarbonate tubes. The short pathlength means less distance for particles to travel in the portion of the tube experiencing greatest centrifugal force, and hence shortened run times. The k factors for half-filled tubes can be calculated by using an approximate r_{\max} and r_{av} in k factor equation (1).

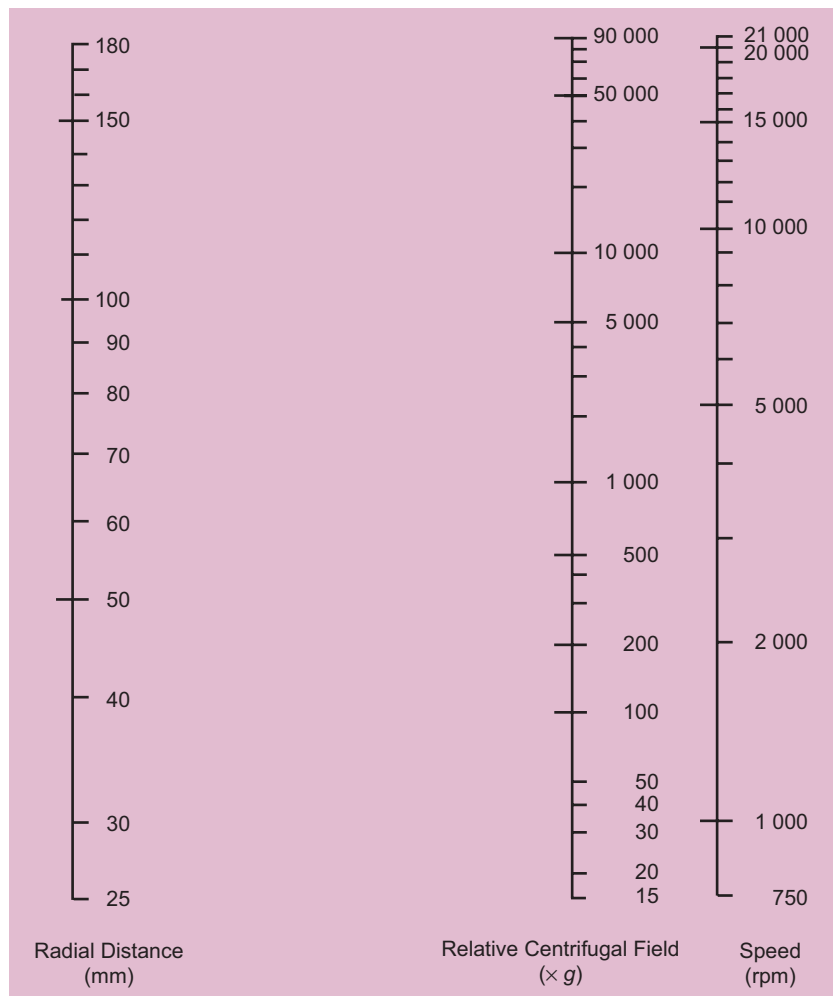

Figure 1-4. Nomogram for J2 Series Centrifuges. Align a straightedge through known values in two columns; read the figure where the straightedge intersects the third column.

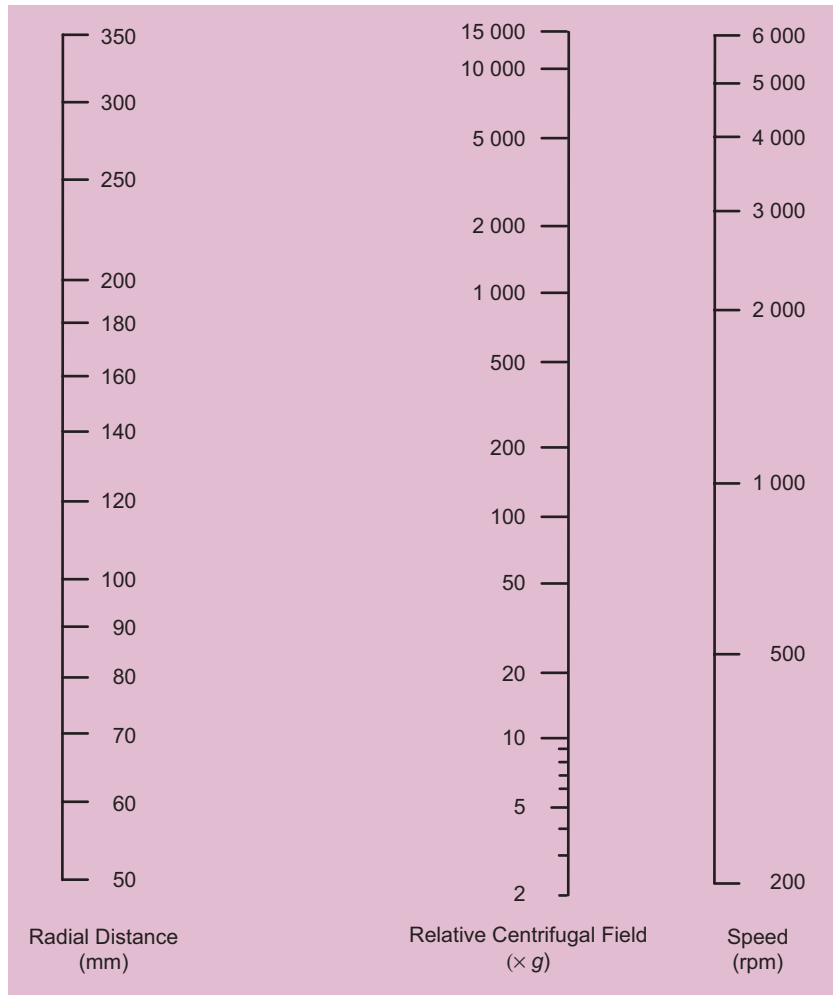

Figure 1-5. Nomogram for J6 Series Centrifuges.
Align a straightedge through known values in two columns;
read the figure where the straightedge intersects the third column.

ISOPYCNIC SEPARATIONS

A sedimentation-equilibrium, or isopycnic, method separates particles on the basis of particle buoyant density. Each component in the sample travels through the gradient until it reaches an equilibrium position. Particle velocity due to differences in density is given in the following expression:

$$v = \left[\frac{d^2(\rho_p - \rho_c)}{18\mu} \right] \times g \quad (6)$$

where

- v = sedimentation velocity (dr/dt)
- d = particle diameter
- ρ_p = particle density
- ρ_c = solution density
- μ = viscosity of liquid media
- g = standard acceleration of gravity

At equilibrium, $\rho_p - \rho_c$ is zero, and particle velocity is therefore zero.

The gradient may be preformed before the run or generated during centrifugation. For gradients formed by centrifugation, the time it takes to form a gradient depends on the sedimentation and diffusion coefficients of the gradient material, the pathlength, and the rotor speed. For a given gradient material, the shorter the pathlength and the higher the rotor speed, the faster the gradient will form. In general, the time required for gradients to reach equilibrium in swinging bucket rotors will be longer than in fixed angle rotors. One way to reduce run times is to use partially filled tubes. Refer to the applicable rotor manual to determine the maximum allowable speed and solution density when using partially filled tubes.

RATE ZONAL SEPARATIONS

Particle separation achieved with rate zonal separation is a function of the particles' sedimentation coefficient (density, size, and shape) and the viscosity of the gradient material. Sucrose is especially useful as a gradient material for rate zonal separation because its physical characteristics are well known and it is readily available. Samples are layered on top of the gradient. Under centrifugal force, particles migrate as zones. Rate zonal separation is time dependent; if the particles are more dense than the most dense portion of the gradient, some or all of the particles will pellet unless the run is stopped at the appropriate time.

A separation is sometimes a combination of rate zonal and isopycnic. Depending on particle buoyant densities and sedimentation coefficients, some particles may be separated by their differential rates of sedimentation, while others may reach their isopycnic point in the gradient.

In most cases, when banding two or three components by rate zonal separation, run times can be shortened considerably if reduced fill levels are used. Tubes are partially filled with gradient, but the sample volume is not changed (however, gradient capacity will be reduced). Thickwall tubes should be used for this technique, since thinwall tubes will collapse if not full.

BLOOD COMPONENT SEPARATIONS

Centrifugation is the primary method for processing blood because it provides the required high throughput, reproducibility, and versatility. Most blood components can be separated in one or two runs. Generally, two types of runs are performed.

- Soft spin runs, short centrifugation runs (3 to 5 minutes) at low g -forces (2000 to 3000 $\times g$) at ambient temperature, are used to keep small cells or platelets in suspension while the larger cells sediment. This type of run is used to obtain platelet-rich plasma and red blood cell concentrate from whole blood.
- Hard spin runs are longer (5 to 7 minutes), at higher g -forces (4000 to 5000 $\times g$), at ambient temperatures or at 4°C, and are used to separate fresh plasma from cellular components.

Soft spin and hard spin techniques are often combined. Refer to Appendix D for further information about separation of blood components by centrifugation.

GENERAL OPERATING INFORMATION

Careful centrifugation technique is essential, because forces generated in high-speed centrifugation can be enormous. For example, 10 grams at the bottom of a JA-25.50 fixed angle rotor rotating at 25 000 rpm exerts the gravitational equivalent of 0.8 ton of centrifugal mass at the bottom of the tube cavity.

NOTE

Specific information about filling, sealing, and capping containers, loading rotors, etc., is contained in later sections.

ROTOR BALANCE

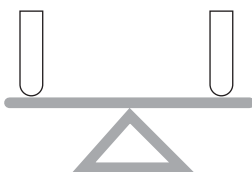

The mass of a properly loaded rotor is evenly distributed on the centrifuge drive hub, causing the rotor to turn smoothly with the drive. An improperly loaded rotor will be unbalanced; consistent running of unbalanced rotors will reduce centrifuge drive life. To balance the rotor load, fill all opposing containers to the same level

with liquid of the same density. Weight of opposing containers must be distributed equally. Place tubes in a fixed angle, vertical tube, or JS-24 series swinging bucket rotor symmetrically, as illustrated in Figure 1-6. Detailed information about balancing other swinging bucket rotors is contained in Section 5.

If sample quantity is limited and the rotor is not balanced, do one of the following to balance the rotor, depending on the rotor in use:

- Load the opposite rotor cavities or buckets with tubes containing a liquid of the same density as opposing tubes.
- Layer a low-density, immiscible liquid, such as mineral oil, on top of the sample to fill opposing tubes to the same level.

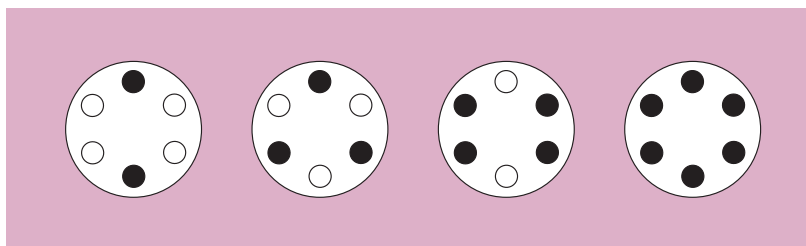
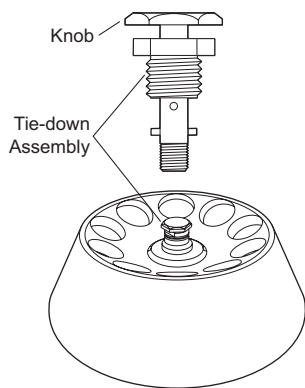

Figure 1-6. Arranging Tubes Symmetrically in a Fixed Angle, Vertical Tube, or JS-24 Series Swinging Bucket Rotor. For example, two, three, four, or six tubes can be arranged symmetrically in a six-place rotor.

ROTOR TIE-DOWN



To secure the rotor to the drive spindle hub during centrifugation, J series rotors are equipped with devices that screw into the hub. If the rotor is left in the centrifuge between runs, tighten the tie-down device before each run.

- Some rotors are equipped with tie-down assemblies. These may be knobs that can be hand-tightened when the rotor is installed, and between runs if the rotor is left in the centrifuge. Other tie-down assemblies are tightened by turning the rotor lid knob.

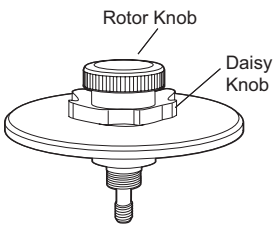

- Some new and modified rotors have dual-locking lid mechanisms. The dual-locking lid mechanism consists of a daisy knob that secures the lid to the rotor, and a tie-down knob that attaches the rotor to the centrifuge drive hub. (Daisy refers to the knob shape. The grooves between each “petal” let your fingers grip the knob firmly and provide leverage for turning.) The daisy knob allows you to attach the lid to the rotor before placing the rotor into the centrifuge, and to remove the rotor from the centrifuge with the lid attached.



CAUTION

Always loosen the rotor knob before loosening the daisy knob to avoid jamming the knobs.

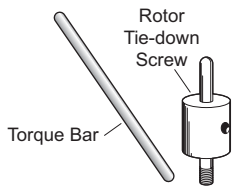

- Other rotors are secured to the centrifuge drive spindle hub by a tie-down screw. A torque bar is supplied with the rotor to provide leverage to securely fasten the rotor.

OVERSPEED PROTECTION

Rotors are specifically designed to withstand a maximum load (that is, volume and density of the rotor contents) at rated speed. At greater speeds, or at rated speeds with heavier loads, rotors are subject to failure.

- In *Avanti J series centrifuges*, an electronic recognition system identifies the rotor, thereby limiting speed to the rated speed of the rotor.
- In J2 and J6 series centrifuges with *analog controls*, the rotor speed is limited by the physical properties of the rotor. Friction created by the air in the centrifuge chamber interacting with the rotor surfaces during centrifugation in most cases prevents rotors from exceeding their rated speeds.
- In *microprocessor-controlled J2 and J6 series centrifuges*, internal circuitry monitors the rotor speed and prevents a rotor from exceeding its rated speed. The rotor entry code listed in the applicable rotor manual sets the allowable speed.

At rated speeds with heavier loads, rotors are subject to failure. It is the operator’s responsibility to limit rotor speed when centrifuging dense solutions or when using heavy containers; refer to ALLOWABLE RUN SPEEDS below.

ALLOWABLE RUN SPEEDS

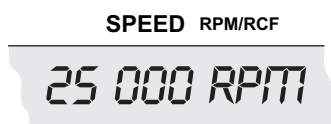

Under some conditions, the maximum allowable speed of the rotor (indicated by the rotor name) must be reduced to ensure that neither the rotor nor the labware are overstressed during centrifugation.

- *Dense Solutions.* When using dense solutions (> 1.2 g/mL) in J2 series rotors, determine maximum run speed using the following square-root reduction formula:

$$\text{reduced run speed} = \text{maximum rated speed} \sqrt{\frac{\rho_A}{\rho_B}} \quad (7)$$

where ρ_A is the maximum permissible density of the tube contents for a particular rotor (from the rotor manual), and ρ_B is the actual density of the tube contents to be centrifuged.

When using dense solutions in J6 series rotors, determine maximum run speed using the following square-root reduction formula:

$$\text{reduced run speed} = \text{maximum rated speed} \sqrt{\frac{A}{B}} \quad (8)$$

where A is 2500 grams for JS rotors or 1500 grams for the JR-3.2 rotor, and B is the weight in grams of a total load (bucket with adapter and sample; bucket with blood bag cup and filled blood bag; tray with racks, tubes, and sample).

NOTE

The maximum speed for Avanti J or J2 series rotors in J6 series instruments is 6000 rpm with solutions of density no greater than 2.0 g/mL. *Solutions of density greater than 2.0 g/mL should not be centrifuged.*

- *Critical Speed Range.* The critical speed range of a rotor is the range of speeds in which, during acceleration, the rotor shifts so as to rotate about its center of mass. While passing through this speed range, the rotor will usually vibrate. Do not set operating speeds that are within a rotor's critical speed range (as listed in the rotor manual).

- *Minimum Speeds.* Some buckets or carriers will not achieve their full horizontal position if the rotor is run below minimum rotating speed. Refer to the individual rotor manual for speed requirements.

TEMPERATURE COMPENSATION

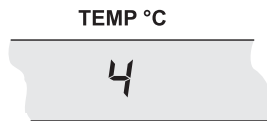

To ensure that the rotor reaches the required temperature during centrifugation, some temperature compensation may be required because of the mass of these rotors. Tables listing temperature compensation units for various rotors are contained in Appendix B and individual rotor manuals. Follow the instructions below for the model of centrifuge being used.

Avanti J Series Centrifuges

Avanti J series centrifuges provide automatic temperature compensation. Enter the run temperature according to the instructions in your centrifuge instruction manual. No additional input is required.

Analog J2 Series Centrifuges (No longer manufactured)

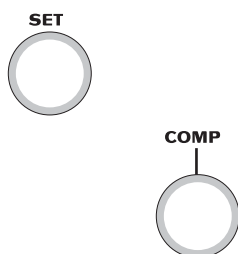

Set temperature compensation in analog J2 model centrifuges (models J2-HS, J2-21, and J2-HC) as follows.

1. Turn the SET knob on the centrifuge panel to the required sample temperature.
2. Find the compensation value in Appendix B (or in the applicable rotor manual) that corresponds with the required temperature and run speed. Set the COMP dial to that setting. (Interpolate if intermediate values are required.)

NOTE

Temperature settings for J-21 series centrifuges must be empirically determined.

Analog J6 Series Centrifuges (No longer manufactured)

Set temperature compensation in analog J6 model centrifuges (models J6-HC and J6-B) as follows.

1. Find the compensation value in Appendix B (or in the applicable rotor manual) that corresponds with the required temperature and run speed. (Interpolate if intermediate values are required.)
2. Turn the SET knob on the centrifuge control panel to the required sample temperature.

Microprocessor-Controlled Centrifuges

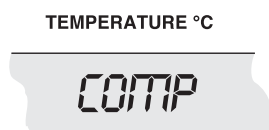

Operating temperatures for most rotors are contained in memory in microprocessor-controlled centrifuges (model J6-MI, and discontinued models J6-MC, J2-MI, J2-21M, J2-MC, and J2-21M/E). Set temperature compensation as follows for rotors not in centrifuge memory.

1. Press the [TEMP] key on the centrifuge control panel and then use the keypad to enter the required sample temperature.
2. Find the compensation value in Appendix B (or in the applicable rotor manual) that corresponds with the required temperature and run speed.
3. Press [COMP ADJ]. The word “COMP” flashes in the TEMPERATURE display and the display flashes.
4. Use the keypad to enter the compensation value. Press the [±.] key to enter a minus sign; pressing it again will remove the minus sign.
5. Check the temperature display. If the entry is incorrect, press [ce] and reenter the digits.
6. When the entry is correct, press [ENTER/RECALL].

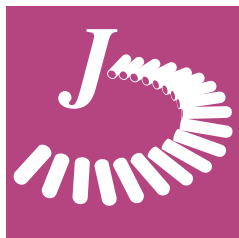

Tubes, Bottles, and Accessories

This section describes various labware used in Beckman Coulter J series rotors. General instructions for using containers follow in Section 3. Care and maintenance instructions are in Section 7. General rotor use instructions are in Sections 4 through 6. The individual rotor manual that comes with each rotor provides specific instructions on the tubes, bottles, and accessories that can be used in a particular rotor.¹ A table of chemical resistances can be found in Appendix A of this manual.

LABWARE SELECTION CRITERIA

No single tube or bottle design or material meets all application requirements. Labware choice is usually based on a number of factors.

- The centrifugation technique to be used, including the rotor in use, quantity of sample to be centrifuged, need for sterilization, importance of band visibility, and so forth
- Chemical resistance—the nature of the sample and any solvent or gradient media
- Temperature and speed considerations
- Whether tubes or bottles are to be reused

Table 2-1 contains an overview of some of the characteristics of tube and bottle materials.

¹ A complete list of tubes, bottles, and accessories is provided in the latest edition of the Beckman Coulter *High Performance, High Speed, High Capacity Rotors, Tubes & Accessories* catalog (BR-8102), available at www.beckmancoulter.com.

Table 2-1. Characteristics and Chemical Resistances of Tube and Bottle Materials.
Refer to Appendix A for information about specific solutions.

| Tube or Bottle Type | Optical Property | Puncturable | Sliceable | Reusable | Acids (dilute or weak) | Acids (strong) | Alcohols (aliphatic) | Aldehydes | Bases | Esters | Hydrocarbons (aliphatic) | Hydrocarbons (aromatic and halogenated) | Ketones | Oxidizing Agents (strong) | Salts |
|-----------------------|-----------------------------|-------------|-----------|----------|------------------------|----------------|----------------------|-----------|-------|--------|--------------------------|---|---------|---------------------------|-------|
| thinwall polyallomer | transparent | yes | yes | no | S | U | U | M | S | U | U | U | U | U | S |
| thickwall polyallomer | translucent | no | no* | yes | S | S | S | M | S | M | M | U | M | U | S |
| Ultra-Clear | transparent | yes | yes | no | S | U | U | S | U | U | U | U | U | U | M |
| polycarbonate | transparent | no | no | yes | M | U | U | M | U | U | U | U | U | M | M |
| polypropylene | translucent/ transparent | no | no* | yes | S | S | S | M | S | M | S | M | M | M | S |
| polyethylene | transparent/ translucent | yes | no | yes | S | S | S | S | S | S | U | M | M | M | S |
| cellulose propionate | transparent | no | no* | no | S | U | U | U | U | M | S | S | U | M | S |
| stainless steel | opaque | no | no | yes | S | U | S | S | M | S | S | S | M | S | M |

S = satisfactory resistance M = marginal resistance U = unsatisfactory resistance

* Polyallomer, polypropylene, and cellulose propionate tubes with diameters of 5 to 13 mm may be sliced using the Centritube Slicer (part number 347960) and appropriate adapter plate.

 **NOTE**

This information has been consolidated from a number of sources and is provided *only* as a guide to the selection of tube or bottle materials. Soak tests at 1 g (at 20°C) established the data for most of the materials; reactions may vary under the stress of centrifugation, or with extended contact or temperature variations. To prevent failure and loss of valuable sample, **ALWAYS TEST SOLUTIONS UNDER OPERATING CONDITIONS BEFORE USE.**

 **WARNING**

Do not use flammable substances in or near operating centrifuges.

LABWARE MATERIAL COMPATIBILITY WITH SOLVENTS AND SAMPLE

The chemical compatibility of tube or bottle materials with the gradient-forming medium or other chemicals in the solution is an important consideration. Although neutral sucrose and salt solutions cause no problems, alkaline solutions cannot be used in Ultra-Clear tubes or in polycarbonate tubes and bottles. Polycarbonate and Ultra-Clear tubes are incompatible with DMSO, sometimes used in the preparation of sucrose gradients for sedimentation of denatured DNA.

GRADIENT FORMATION AND FRACTIONATION

Consideration should be given to gradient formation and fractionation when choosing a tube for a density gradient run. If the bands or zones formed during centrifugation are indistinct, they may not be visible through a translucent material such as polyallomer. If optimum band visualization is important, Ultra-Clear, polycarbonate, or cellulose propionate tubes should be used. Whenever collection of bands or zones must be done by slicing or puncturing the tube, a thin, flexible tube wall is required. Ultra-Clear or polyallomer tubes should be used in these cases, depending on the need for transparency.

LABWARE TYPES

NOTE

Tubes made of cellulose nitrate were formerly popular for various separations, particularly rate-zonal separations. Beckman Coulter discontinued the use of cellulose nitrate for tube manufacture in 1980, due to inconsistent physical properties inherent in the material. If you currently have cellulose nitrate tubes, dispose of them. Consult your laboratory safety officer for proper disposal procedures.

POLYALLOMER TUBES

Polyallomer is a copolymer of ethylene and propylene. Polyallomer tubes are translucent or transparent in appearance, depending on wall thickness, and are nonwetttable (although some polyallomer tubes can be chemically treated to make them wetttable). Polyallomer tubes have good tolerance to all gradient media, including alkalines. They perform well with most acids, many bases, many alcohols, DMSO, and some organic solvents. Several types of polyallomer tubes are available.

Open-Top Polyallomer Tubes



Thinwall open-top tubes are used in swinging bucket and fixed angle rotors. In swinging bucket rotors, thinwall tubes should be filled to within 2 or 3 mm of the tube top for proper tube support. Caps are usually required in fixed angle rotors. Thinwall tubes are designed for one-time use and should be discarded after use.



Thickwall open-top tubes offer the convenience of centrifuging partially filled tubes without tube caps in fixed angle and swinging bucket rotors. Because the solution reorients during centrifugation, the maximum partial fill volume depends on the tube angle. For greater fill volumes, use tubes with caps. Refer to the applicable rotor manual for fill volumes and speed reduction requirements. Thickwall tubes are reusable.

Quick-Seal® Polyallomer Tubes

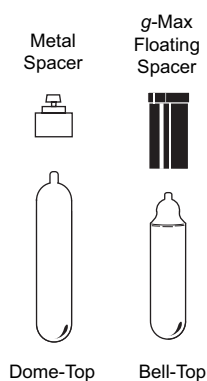

Heat-sealed Quick-Seal tubes can be used in some fixed angle rotors and in the JS-24 series rotors; they *must be used* in the JV-20 vertical tube rotor. Single-use Quick-Seal tubes are a convenient form of sealable tube; they are especially useful for the containment of radioactive or pathogenic samples. There are two Quick-Seal tube designs, dome-top and bell-top.

- The bell-top simplifies removal of materials that float during centrifugation.
- Dome-top tubes hold more volume than their bell-top equivalents.

Detailed information about Quick-Seal tubes is contained in publication IN-181.

POLYCARBONATE TUBES



Polycarbonate is tough, rigid, nonwetable, and glass-like in appearance. Polycarbonate tubes are reusable and can be used with or without caps in fixed angle rotors, and at least half full in swinging bucket rotors. Speed reduction may be required in some rotors if the tubes are not completely filled.

Although polycarbonate tubes may be autoclaved, doing so greatly reduces the usable life of these tubes. Cold sterilization methods are recommended. Washing with alkaline detergents can cause failure. Crazing—the appearance of fine cracks in the tube—is the result of stress “relaxation” and can affect tube performance. These cracks will gradually increase in size and depth, becoming more visible. Tubes should be discarded before cracks become large enough for fluid to escape. These tubes have good tolerance to all gradient media except alkalines (pH greater than 8). They are satisfactory for some weak acids, but are unsatisfactory for all bases, alcohol, and other organic solvents.

POLYPROPYLENE TUBES

Polypropylene tubes are translucent in appearance and are reusable unless deformed during centrifugation or autoclaving. These tubes have good tolerance to gradient media including alkalines. They are satisfactory for many acids, bases, and alcohols, but are unsatisfactory for most organic solvents. They can be used with or without caps in fixed angle rotors. Speed reduction is sometimes required with these tubes if run with less than full volume (refer to your rotor manual).

POLYETHYLENE TUBES

Polyethylene tubes are translucent or transparent and have a good tolerance for use with strong acids and bases. They are reusable but cannot be autoclaved. In swinging bucket rotors, they are used without caps, and with or without caps in fixed angle rotors.

ULTRA-CLEAR TUBES



Ultra-Clear tubes, made of a tough thermoplastic, are thinwall and not wettable (but can be made wettable; see Section 3). Ultra-Clear tubes are available in two types—open-top and Quick-Seal. They are transparent centrifuge tubes, offering easy location of visible banded samples. Standard straight-wall Ultra-Clear tubes must be filled completely and capped for use in fixed angle rotors.

Ultra-Clear tubes, which can be used one time only, have good resistance to most weak acids and some weak bases, but are unsatisfactory for DMSO and most organic solvents, including all alcohols. Ultra-Clear tubes should not be autoclaved.

STAINLESS STEEL TUBES



Stainless steel tubes offer excellent resistance to organic solvents and heat, but should not be used with most acids or bases. They offer only marginal resistance to most gradient-forming materials other than sucrose and glycerol. Stainless steel tubes are very strong and can be centrifuged when filled to any level. Because of their weight, however, run speeds must often be reduced (see publication L5-TB-072). Stainless steel tubes can be used indefinitely if they are undamaged and not allowed to corrode. They may be autoclaved after use as long as they are thoroughly dried before storage.

MICROFUGE® TUBES



Microfuge tubes, 1.5-mL tubes with attached caps, are made of clear polyallomer or of clear or colored polypropylene. The tubes are placed in adapters for use in some fixed angle rotors. They are also used in multitube adapters in the buckets or carriers of swinging bucket rotors. The number and arrangement of tubes in opposing adapters should be balanced.

BOTTLES



Bottles are available in polycarbonate (hard and clear), polypropylene (translucent), and polyallomer (translucent). Sealed polyallomer or polycarbonate bottles, available for most fixed angle rotors, have a three-piece liquid-tight cap assembly. Other bottles have screw-on caps. Cap assemblies should always be removed before autoclaving bottles. Bottle selection depends on the rotor in use and the specific application; refer to the applicable rotor manual.

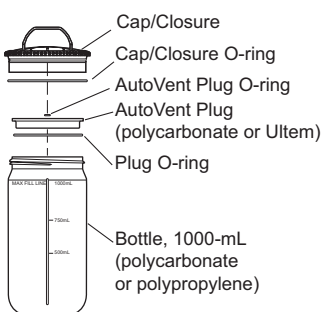

JLA-8.1000 and JLA-9.1000 J-Lite rotors run only the specially designed Beckman Coulter bottles and accessories with polycarbonate plug seals. A Radel cap/closure, placed over the plug, screws onto the bottle. During centrifugation, the cap/closure is pulled down into the cannister, creating a tight seal. The cap/closure provides secondary containment of the sample in the event of bottle leakage. O-rings on the plug and the cap/closure create the seals (*the O-rings must be free of defects, dry, and unlubricated to ensure sealing*).

MULTIWELL TITER PLATES

Titer plates can be run in specially designed carriers in some swinging bucket rotors. Carriers are used by installing them on the pivot pins in place of the buckets normally used with the rotor, or in buckets designed to run plates. Because the plates can break under the stresses of high-speed centrifugation, speed reduction is usually required when running multiwell plates. Multiwell plates are also used in adapters in the rack-type rotor.

96-Well Microtiter Plates

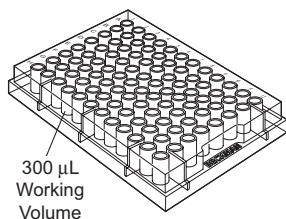

The 96-well plates are manufactured of specially formulated polystyrene. These flat-bottom, nonsterile plates normally hold 300 µL per well of sample and solvent.

Deep-Well Titer Plates (and Caps)

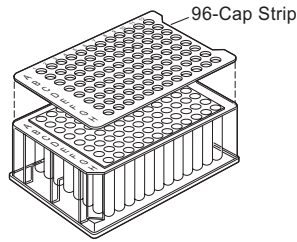

These plates are manufactured of sterile or nonsterile polystyrene or polypropylene. The plates can contain up to 1.2 mL per well of sample and solvent in a single 96-well plate when run uncapped. When used with caps, which come in 96-cap strips, each well accommodates 1.0 mL.

Square-Well Titer Plates

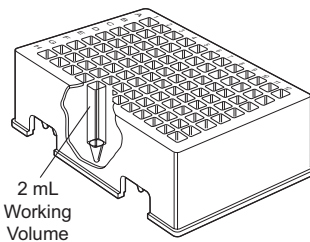

Square-well plates are manufactured of nonsterile polypropylene. The square-well format provides 2 mL per well capacity in each 96-well plate.

TEMPERATURE LIMITS

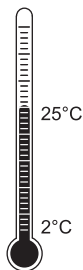

Each labware material has a specified temperature range. Although some high-speed centrifuges can achieve temperatures as high as 45°C, only certain tube or bottle materials can be run under these conditions. Most containers are made of thermoplastic materials that soften at elevated temperatures. This temperature-induced softening, together with such factors as the centrifugal force, the run duration, the type of rotor, previous run history, and the tube angle, can cause labware to collapse. Therefore, if high-temperature runs—above 25°C—are required, it is best to pretest labware under the actual experimental conditions, using buffer or gradient of similar density rather than a valuable sample. (Stainless steel tubes can be centrifuged at any temperature.)

- Plastic labware has been centrifuge tested for use at temperatures between 2 and 25°C. For centrifugation at other temperatures, pretest tubes under anticipated run conditions.
- If plastic containers are frozen before use, make sure that they are thawed to at least 2°C prior to centrifugation.

SPACERS AND FLOATING SPACERS

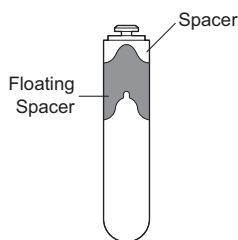

Quick-Seal tubes require spacers made of anodized aluminum, with or without floating spacers. The particular combination depends on the type of rotor being used and the tube size.

- In swinging bucket and fixed angle rotors, the top of the tube must be supported.
- In vertical tube rotors, the entire cavity must be filled.

Plastic spacers have been tested for centrifugation between 2 and 25°C. If spacers are centrifuged at temperatures significantly greater than 25°C, deformation of the spacer and tube may occur.

ADAPTERS

Many rotors can accommodate a variety of tube sizes by using adapters that line the tube cavity or bucket. Adapters are fabricated of several different kinds of materials, depending on the rotor and the tube to be used in them. Some of the common materials are Delrin,² Noryl,³ Ultem, polyethylene, rubber, polypropylene, and glass-filled or foamed polypropylene.

Tubes or bottles used with adapters can be filled (and capped, if applicable), according to the type of tube and the design of the rotor being used.

BOTTLE ADAPTERS

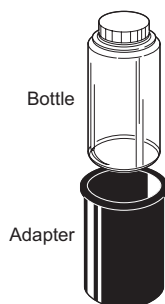

Bottles are often supported during centrifugation in bottle adapters that fit inside the rotor buckets or cavities. The adapters are usually ribbed for strength and support a variety of bottle sizes.

To prevent the bottles from stretching or breaking, a plastic sleeve, or adapter, must be used around each Beckman Coulter 1-liter bottle during centrifugation in J6 series rotors. In other rotors, if the bottles fit snugly in the buckets, the adapters are not required. (Refer to the applicable rotor manual.)

² Delrin is a registered trademark of E. I. Du Pont de Nemours & Company.

³ Noryl and Ultem are registered trademarks of GE Plastics.

MULTITUBE ADAPTERS

Adapters are used to enable centrifugation of multiple tubes in the bucket of a swinging bucket rotor or in a fixed angle tube cavity.

Solid Multitube Adapters

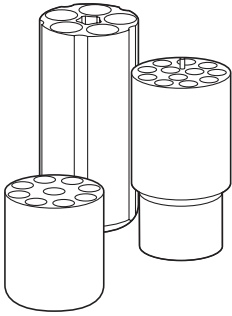

These solid adapters, available in several tube configurations, are made of Ultem, Noryl, polypropylene, or aluminum that is anodized for corrosion protection. They can be filled and loaded into rotor buckets or cavities without any preparation. These adapters can also be used as tube racks in the laboratory.

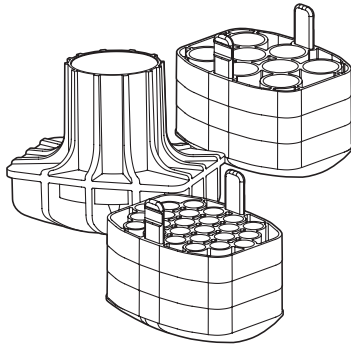

Modular Disk Adapters

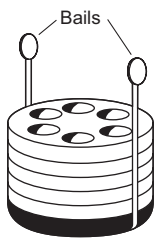

These adapters can also be used as tube racks in the laboratory. The adapter disks are color-coded by the tube size they accommodate; the number of disks used in an adapter assembly depends upon the length of tubes used. Refer to the applicable rotor manual to determine the kind of adapter required for the tubes you are using. A tube decanter is available to hold tubes securely in some adapters, allowing all tubes to be decanted at once.



Do not intermix modular adapters (or their individual parts) from Beckman Coulter's J6 series rotors with those for the JS-4.3 rotor. While the adapters are similar in appearance, they have very different weights. J6 adapters have bails (vertical supports) that are curved at the top; bails for the JS-4.3 adapters are straight. Keep J6 and JS-4.3 disks and bases separate from each other—mixing them can cause imbalance. In addition, the J6 adapter bails will interfere with the JS-4.3 rotor yoke when the buckets swing up to horizontal position.

BOTTLE AND TUBE CAPS

The need for caps depends on such factors as the kind of rotor being used, the type of container, and the amount of sample being centrifuged.

Some tubes must be capped before centrifugation, as in the case of thinwall tubes. The thickness and strength of some containers, such as thickwall plastic and stainless steel tubes used in fixed angle and swinging bucket rotors, allows them to be run without caps, but they must be only partially filled. (Refer to the applicable rotor manual for allowable capless fill levels.) When greater fill volumes are required in these tubes, caps must be used for sample retention.

When closed containers are required, several choices are available:

- Cap assemblies—threaded caps with inserts and O-rings, or one-piece caps with O-rings, that provide a leakproof closure to accommodate a capacity container load (that is, to the bottom of the insert).
- Threaded caps without inserts or O-rings—these are not as liquid-tight as the cap assemblies; therefore, the meniscus must be kept lower to prevent leakage.
- Snap-on caps—these caps are simple to use but are not as liquid-tight as the cap assemblies or threaded caps. They require an even lower meniscus to prevent leakage.

AEROSOLVE™ CANNISTERS

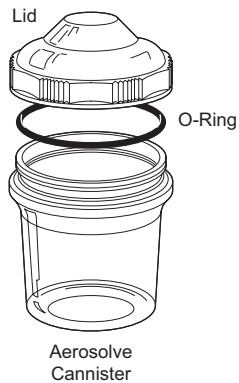

Aerosolve cannisters, used in the JS-4.3 swinging bucket rotor, are designed to minimize aerosol leakage and liquid spills. The cannister is transparent, enabling you to see broken labware and take proper precautions before opening the cannister.

The cannister and lid are made of polyphenylsulfone, tube racks are made of polypropylene, and the O-ring is ethylene-propylene rubber. Refer to Appendix A, Chemical Resistances, to determine compatibilities with specific chemicals.

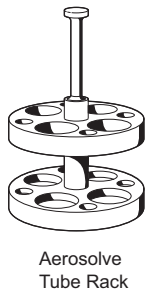

Each cannister can hold a variety of tube sizes in tube racks that are specifically designed to fit in the cannisters. The cannister can also be used as a 500-mL wide-mouth bottle.



WARNING

When centrifuging hazardous materials, always open cannisters in an appropriate hood or biological safety cabinet.

BLOOD BAG CUPS

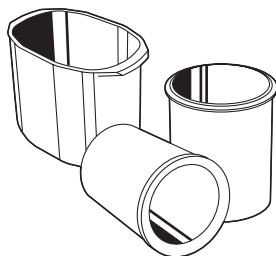

Polypropylene blood bag cups are available for use in swinging bucket rotors to obtain cell-free plasma for cell packing or for leukolyte depletion. Different sizes of cups are available to accommodate single, double, triple, or quad pack blood bags. Refer to the applicable rotor manual to determine the correct blood bag cup to use. Blood bag cups are autoclavable.

Blood bags should be loaded into the cups outside of the centrifuge to avoid tripping the centrifuge imbalance monitor during loading.

ROTOR LABWARE ASSEMBLIES

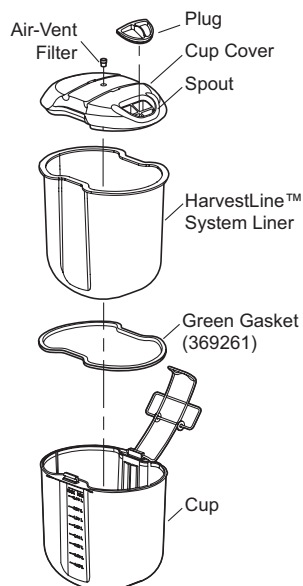

The JS-5.0 labware assembly has an available HarvestLine™ System liner. If liners are not used, the sample can be loaded directly into the cup and a partition can be inserted to minimize sample disturbance at low g forces. The gasket and the cup and cover surfaces that contact the gasket must be dry to ensure sealing. Gasket 36926 (green) is used when liners are used; gasket 369257 (red) is used when the cup is used alone, with or without a partition. The cup cover top surface can be written on to identify the assembly or sample.

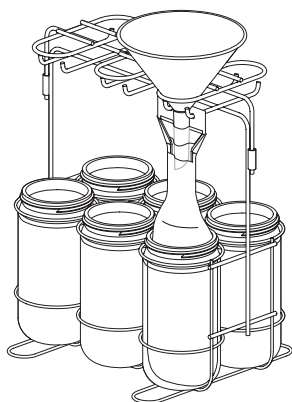

The HarvestLine™ System for the JLA-8.1000 and JLA-9.1000 rotors provides a convenient method of loading, recovering, and storing samples run in these rotors. Up to six rotor bottles are placed in the filling rack, and a liner is placed into each bottle. The liners are loaded with sample through a funnel or fermentor hose. The valve in the neck of each liner is then sealed and the liner necks folded to fit inside the bottles. The bottles are sealed with rotor plugs and cap/closures, and the sealed bottles are placed into the rotor cannisters for centrifugation. After centrifugation, the liner valves are cut off and the supernatant decanted, either for storage or disposal. The liners can then be heat-sealed for pellet storage or disposal.

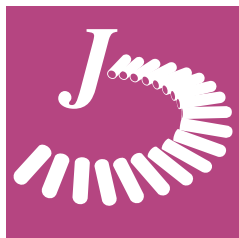

Using Tubes, Bottles, and Accessories

This section contains general instructions for filling and capping the labware used in Beckman Coulter J series rotors, for selecting and using the appropriate accessories, and for recovering samples after a run. Individual rotor manuals provide specific instructions on tubes, bottles, and accessories that can be used in a particular rotor.¹

Rotor use instructions are in Section 4 for fixed angle rotors, in Section 5 for swinging bucket rotors, and in Section 6 for vertical tube and rack-type rotors. A table of chemical resistances is in Appendix A of this manual. Reference information on some commonly used gradient materials is in Appendix C.

GRADIENT PREPARATION

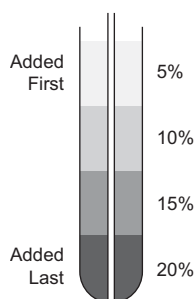

Many commercial gradient formers are available. These devices usually load a tube by allowing the gradient solutions to run down the side of the tube. The heaviest concentration is loaded first, followed by successively lighter concentrations. This method is acceptable for wettable tubes; however, loading a nonwetable tube (such as Ultra-Clear, polyallomer,² and polycarbonate) by allowing solutions to run down the side of the tube can cause mixing.

Gradients in nonwetable tubes can be prepared using a gradient former by placing a long syringe needle or tubing to the tube bottom and reversing the gradient chambers. In that way the lightest gradient concentration is loaded first, underlayed by increasingly heavier concentrations.

¹ A complete list of tubes, bottles, and adapters is provided in the latest edition of the Beckman Coulter *High Performance, High Speed, High Capacity Rotors, Tubes & Accessories* catalog (BR-8102), available at www.beckmancoulter.com.

² It has been reported, however, that polyallomer tubes have been made wettable by soaking them in a chromic acid bath for about 30 minutes (see *Preparation of Polyallomer Centrifuge Tubes for Density Gradients*, Anal. Biochem. 32:334-339. H. Wallace, 1969). Also, a method of making Ultra-Clear tubes wettable that has proven successful for some users is described at the end of this section.

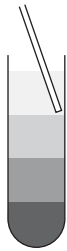

You can also prepare preformed step gradients by hand, using a pipette. Carefully layer solutions of decreasing concentration by placing the tip of the pipette at the angle formed by the tube wall and the meniscus, or float the lighter gradient concentrations up by adding increased density solutions to the tube bottom using a hypodermic syringe with a long needle such as a pipetting needle.

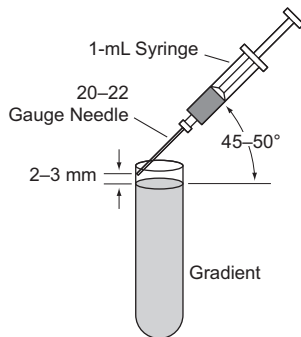

Another way to form a linear gradient is to allow a step gradient to diffuse to linearity. Depending on the concentration differential between steps and the cross-sectional area, allow 3 to 6 hours for diffusion at room temperature, and about 16 hours at 0 to 4°C. For diffusion of step gradient in Quick-Seal and capped straightwall tubes, slowly lay the tube on its side (tube contents will not spill, but make sure the tube does not roll). After 2 hours at room temperature, slowly set the tube upright.

Once the gradient is prepared, layer the sample on top of the gradient.

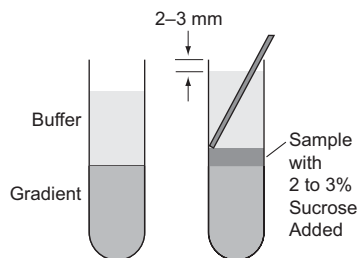

For *thinwall* tubes only partially filled with gradient, add a buffer solution to fill the tube to provide tube wall support. Although the gradient volume is reduced, sample volume is not changed.

NOTE

If a partially filled *thickwall* tube is centrifuged, the tube does not require liquid support, and therefore, the buffer solution is not required.

GENERAL FILLING AND SEALING OR CAPPING REQUIREMENTS

See Table 3-1 for general filling and sealing or capping requirements for tubes and bottles used in J series rotors. Maximum fill volume includes sample and gradient. Refer to individual rotor manuals for specific filling and capping requirements.

Table 3-1. General Filling and Sealing Requirements for Tubes and Bottles

| Tube or Bottle | Filling Level Requirement | | |
|-----------------------------|---|--|----------------------|
| | Swinging Bucket Rotors | Fixed Angle Rotors | Vertical Tube Rotors |
| Polyallomer | | | |
| thinwall tubes | within 2 to 3 mm of top | full with cap | not used |
| thickwall tubes | at least 1/2 full | 1/2 full to max capless level or full with cap | not used |
| Quick-Seal tubes | full and heat sealed | full and heat sealed | full and heat sealed |
| bottles | min to max (see rotor manual) with screw-on cap or cap assembly | 1/2 full to max (see rotor manual) with screw-on cap or cap assembly | not used |
| Ultra-Clear | | | |
| open-top tubes | within 2 to 3 mm of top | full with cap | not used |
| Quick-Seal tubes | not used | full and heat sealed | full and heat sealed |
| Polycarbonate | | | |
| thickwall tubes | at least 1/2 full | 1/2 full to max capless level or full with cap | not used |
| bottles | at least 1/2 full | min to max (see rotor manual) with screw-on cap or cap assembly | not used |
| Stainless Steel | | | |
| tubes | any level | any level with cap or cap assembly | not used |
| Polypropylene | | | |
| tubes and bottles | at least 1/2 full | 1/2 full to max capless level or full with cap or cap assembly | not used |
| Polyethylene | | | |
| tubes | at least 1/2 full | 1/2 full to max capless level or full with cap | not used |
| Cellulose Propionate | | | |
| tubes and bottles | at least 1/2 full | 1/2 full to max capless level | not used |

WORKING WITH PHYSIOLOGICAL FLUIDS



WARNING

Handle body fluids with care because they can transmit disease. No known test offers complete assurance that they are free of micro-organisms. Some of the most virulent—Hepatitis (B and C) and HIV (I–V) viruses, atypical mycobacteria, and certain systemic fungi—further emphasize the need for aerosol protection. Handle other infectious samples according to good laboratory procedures and methods to prevent spread of disease. Because spills may generate aerosols, observe proper safety precautions for aerosol containment. Do not run toxic, pathogenic, or radioactive materials in this rotor without taking appropriate safety precautions. Biosafe containment should be used when Risk Group II materials (as identified in the World Health Organization *Laboratory Biosafety Manual*) are handled; materials of a higher group require more than one level of protection.

When working with potentially hazardous materials, always fill or open containers in an appropriate hood or biological safety cabinet. Three levels of containment are offered by Beckman Coulter, and may be used singly or combined, depending upon your application.

1. Capped tubes or bottles are designed to provide fluid containment. We strongly recommend that all containers carrying physiological fluids be capped to prevent leakage.
2. Rotor or bucket covers are designed to minimize the possibility of fluid leakage during centrifugation.
 - Bucket covers for swinging bucket rotors help to contain fluids within the bucket in the event of tube breakage or blood-bag failure.
 - Some fixed angle rotors have available dual-locking lid mechanisms that provide added biosafety by allowing the rotor to be loaded into and removed from the centrifuge with the lid in place. The rotor may be placed under a safety hood before the lid is attached or removed.
3. Aerosolve cannisters are designed to minimize the possibility of aerosol (and fluid) leakage during centrifugation.

FILLING OPEN-TOP TUBES

OPEN-TOP POLYALLOMER TUBES

Open-top polyallomer tubes are used in swinging bucket and fixed angle rotors.

Swinging Bucket Rotors

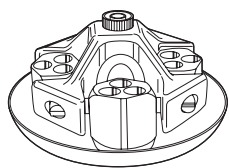

Fill all opposing tubes to the same level.

- *Thinwall Tubes*—Fill to within 2 or 3 mm of the top for proper tube wall support.
- *Thickwall Tubes*—Fill at least half full.

Fixed Angle Rotors

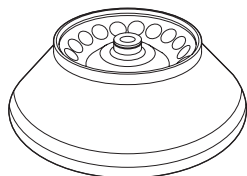

Fill all opposing tubes to the same level.

- *Thinwall Tubes*—Must be completely filled; liquid and cap for support of the tube wall is critical.
- *Thickwall Tubes*—Can be partially filled and centrifuged as indicated in the applicable rotor manual. Speed reductions may be required for these partially filled tubes. For greater fill volumes and faster speeds, tube caps should be used. Refer to the rotor manual for fill volumes and speed limitations.

OTHER OPEN-TOP TUBES

Open-top tubes of other materials can also be used in fixed angle and swinging bucket rotors. (Vertical tube rotors use only Quick-Seal tubes.) Fill these tubes as indicated below.

Polycarbonate

Thickwall polycarbonate tubes can be centrifuged partially filled. Observe maximum rotor speeds and fill volumes listed in the applicable rotor manual.

Ultra-Clear

For *swinging bucket* rotors, fill to within 2 or 3 mm of the top of the tube. Refer to the applicable rotor manual.

Polypropylene

Fill all opposing tubes to the same level.

- For *swinging bucket* rotors, fill to within 2 or 3 mm of the top of the tube.
- Fill thickwall polypropylene tubes at least half full to maximum level in *fixed angle* rotors. Speed reduction is required. Refer to the applicable rotor manual.

Polyethylene

For *swinging bucket* and *fixed angle* rotors, fill these tubes from half full to maximum level. Refer to the applicable rotor manual.

Stainless Steel

Because of their strength, stainless steel tubes can be centrifuged while filled to any level (with all opposing tubes filled to the same level). However, run speeds must be reduced due to their weight. The criteria for speed reduction depends on the tube-cap material and the strength of the rotor being used. Refer to the applicable rotor manual or *Run Speeds for Stainless Steel Tubes* (publication L5-TB-072) for correct run speeds.

CAPPING TUBES

Caps must be used with thinwall polyallomer and Ultra-Clear tubes in fixed angle rotors. To prevent spillage, thickwall polyallomer, polycarbonate, and stainless steel tubes must be capped when fill levels exceed the maximum level for uncapped tubes as listed in the applicable rotor manual.

Cap requirements depend on the tube or bottle material, diameter, and wall thickness, as well as on the rotor. The applicable rotor manual specifies which cap should be used with a particular tube or bottle; use of the wrong cap could cause a rotor mishap.

When closed containers are required, several choices are available:

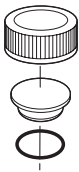

- Cap assemblies—threaded caps with inserts and O-rings that provide a leakproof closure to accommodate a capacity container load (that is, to the bottom of the insert). Single-piece cap assemblies have the insert permanently attached.

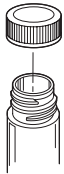

- Threaded caps without inserts or O-rings—these are not as liquid-tight as the cap assemblies; therefore, the meniscus must be kept lower to prevent leakage. Speed reductions may also be required with lower fill volumes.

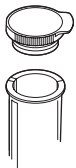

- Snap-on caps—these caps are simple to use but are not as liquid-tight as the cap assemblies or threaded caps. They require an even lower meniscus to prevent leakage.

FILLING AND CAPPING BOTTLES

To prevent spillage and provide support, polycarbonate and polypropylene bottles used in fixed angle rotors must be capped when fill levels exceed the maximum level allowed for uncapped bottles. Bottles should be filled to maximum fill levels when spun at full rated speeds. Unless specified otherwise, the minimum recommended volume for bottles is half full; this will require reduced rotor speed for optimum labware performance. Refer to the applicable rotor manual for bottle fill levels and cap requirements.

THREE-PIECE CAP ASSEMBLIES

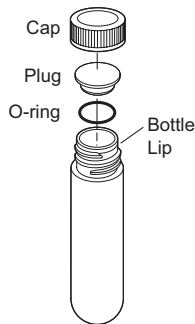

Cap bottles with three-piece cap assemblies as follows:

1. Be sure the O-ring, plug, and bottle lip are dry and free of lubrication.
2. Place the O-ring on the underside of the plug.
3. Insert the plug into the neck of the bottle, ensuring that no fluid contacts the O-ring.
4. Tighten the cap by hand.

JLA-8.1000 AND JLA-9.1000 BOTTLE CAP/CLOSURES

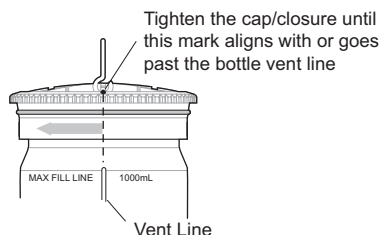

Place the plug on the bottle, then screw on the cap/closure by hand as tightly as possible. Tighten until the timing mark on the cap/closure is aligned with or goes past the vent line on the bottle.

FILLING AND LOADING CUPS IN THE JS-5.0 ROTOR

NOTE

Four labware cups must be used for every run and must be balanced to within 25 grams of each other. *Do not load the rotor with two filled cups and two empty cups.*

1. Insert four labware cups into two cup racks with the cup latch hinges toward the center of the racks.
2. Make sure that the gaskets and sealing surfaces on each cup and cover are clean and dry. Place a gasket around the top edge of each cup, carefully pushing the gasket down until it is fully seated on

the cup. Use green gaskets (369261) if you are using liners. Use red gaskets (369257) if you are using cups alone, with or without partitions.

3. Place a liner in each cup (if applicable).
4. You may fill the cups now, or close the lid and fill through the spout.

NOTE

If liners are not used, partitions (369259) may be inserted into the slots inside the cups. Remove the red cup gaskets (369257) before inserting partitions, and be sure to reinstall the gaskets.

5. Place a cover on each cup and fasten the latch securely. If the latch will not fasten, check to make sure that the gasket is properly installed. The latch cannot be fastened if the gasket is not fully seated. *Be sure that the latch is fastened before lifting the cup by the handle.*
6. If the cups were not filled previously, load sample into each cup through the cover spout using a funnel, tubing (1.27-cm [$1/2$ -in.] O.D.), or a pipette. Use the fill line indicators to assist in filling all four cups to the same level. *All four cups must balance to within 25 grams of each other.* When loading is complete, snap a plug into place in each cover spout.

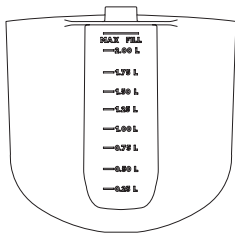

FILLING AND SEALING QUICK-SEAL TUBES

Fill each tube to the base of the neck, using a syringe with a 13-gauge or smaller needle.³ A small air space (no larger than 3 mm) may be left, but an air bubble that is too large can cause the tube to deform, disrupting gradients or sample. Spacer and/or floating spacer requirements for Quick-Seal tubes are described in the individual rotor manuals. The neck of the tube should be clean and dry before sealing.

³ A sample application block (part number 342694) is available for holding and compressing tubes, and can be used to layer samples on preformed gradients in polyallomer Quick-Seal tubes.

There are two tube sealers for use with Quick-Seal tubes—the hand-held Cordless Tube Topper™, and the older tabletop model (no longer available). Refer to *How to Use Quick-Seal® Tubes with the Beckman Coulter Cordless Tube Topper™* (publication IN-181) for detailed information about the Tube Topper. Instructions for using the older tabletop tube sealer are in *How to Use Quick-Seal® Tubes with the Beckman Tube Sealer* (publication IN-163).

Quick-Seal tubes are heat-sealed quickly and easily using the Beckman Coulter Cordless Tube Topper (see Figure 3-1). The following procedures provide the two methods for heat-sealing Quick-Seal tubes using the hand-held Tube Topper. Use the applicable tube rack listed in the rotor manual.

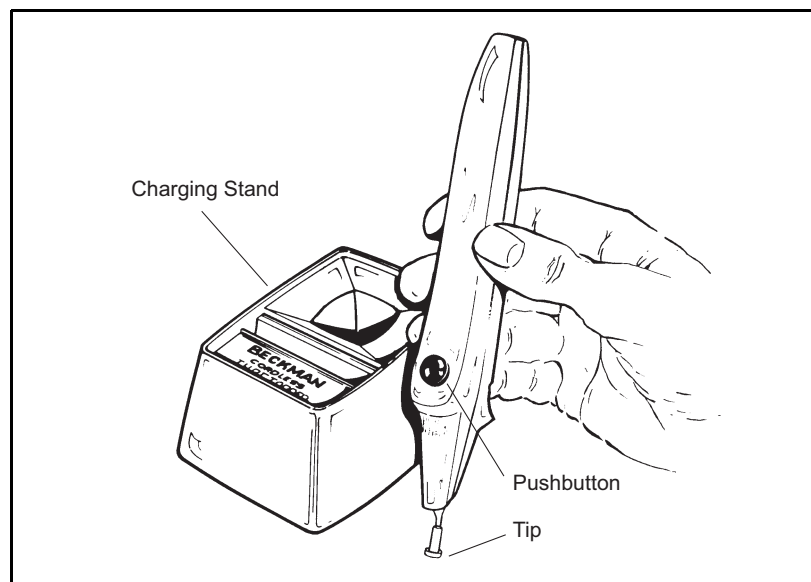

Figure 3-1. The Cordless Quick-Seal Tube Topper



CAUTION

Before plugging in the Tube Topper, be sure that you have a proper power source (120 V, 50 or 60 Hz). Charge your Cordless Tube Topper only in the charging stand supplied with it.

1. Remove the Tube Topper from the charging stand. Leave the pushbutton turned to LOCK position.



WARNING

Touching the heated tip of the Tube Topper will cause burns. When the pushbutton is pressed, the tip heats almost immediately. Make sure the pushbutton is turned to LOCK position unless you are actually sealing a tube.

Seal Former

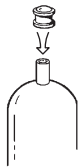

2. Place a seal former on each tube stem. (The Teflon⁴ coating on the seal formers is permanent. Do not scratch the interior of the formers, as you may damage this coating.)
3. Seal each tube using Method A or B. *Method A is preferable when sealing smaller tubes or when resealing a tube that leaks.*



CAUTION

Always keep the Tube Topper in its charging stand when not in use. Do not lay the unit against any surface after use until the tip has cooled (3 to 5 minutes after shut off).

⁴ Teflon is a registered trademark of E.I. Du Pont de Nemours & Co.

METHOD A — WITH THE SEAL GUIDE



- a. Place a seal guide (with the flat side down) over the seal former.
- b. Turn the Tube Topper pushbutton to USE position. Press the pushbutton and wait 3 to 5 seconds for the tip to heat.
- c. Apply the tip of the Tube Topper vertically to the seal former. Press down gently for about 10 seconds. The seal guide should move down the tube stem until it rests on the tube shoulder. Using the seal guide prevents the seal former from being pressed into the tube shoulder.

NOTE

Always apply the tip of the Tube Topper vertically to the seal former. Apply gentle pressure when sealing the tube.

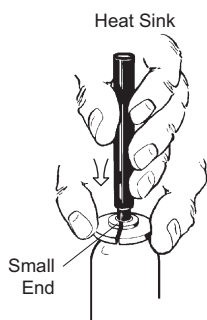

- d. When the seal guide has moved to the correct position, remove the Tube Topper and pinch the circular seal guide to hold the seal former in place.
- e. Place the heat sink (small end) over the cap for 2 to 3 seconds while the plastic cools—do NOT let the seal former pop up. (If the seal former does pop up, the tube may not have an adequate seal and may need to be resealed.)



- f. Remove the heat sink and seal guide. When the seal former cools, remove it by hand or with the removal tool (361668). Save the seal guide and former for future use.

METHOD B — WITHOUT THE SEAL GUIDE

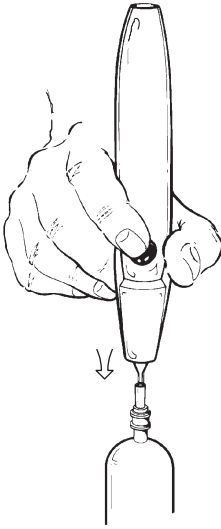

NOTE

Always apply the tip of the Tube Topper vertically to the seal former. Apply gentle pressure when sealing the tube.

- a. Turn the Tube Topper pushbutton to USE position. Press the pushbutton and wait 3 to 5 seconds for the tip to heat.
- b. Apply the tip of the Tube Topper vertically to the seal former. The seal former should move down the tube stem until it just rests on the tube shoulder. Be careful NOT to press the seal former into the tube shoulder; it may cause the tube to leak.

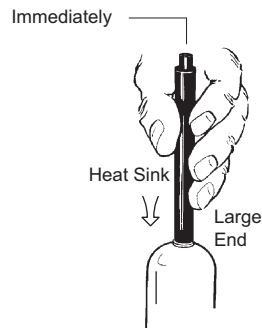

NOTE

It is very important to apply the heat sink immediately. To do so, we recommend that you have it in one hand, ready to apply as soon as needed.

- c. Remove the Tube Topper. IMMEDIATELY place the large end of the heat sink over the seal former. Hold it there for a few seconds while the plastic cools—do NOT let the seal former pop up. (If the seal former does pop up, the tube may not have an adequate seal and may need to be resealed.)
- d. Remove the heat sink. When the seal former cools, remove it by hand or with the removal tool (361668).

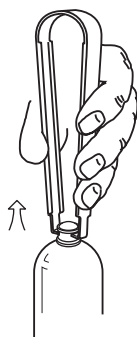

4. After completing either heat-sealing method, squeeze the tube gently (if the tube contents may be disturbed) to test the seal for leaks. If the tube does leak, try resealing it using Method A.
5. The tube is now ready for centrifugation. Seal the remaining tubes.
6. Return the Tube Topper to its charging stand when finished.

CAPPING MULTIWELL TITER PLATES

Multiwell titer plates—regular, deep-well, and square-well—can be run uncovered or using one of the available cover types.

Cap Strips

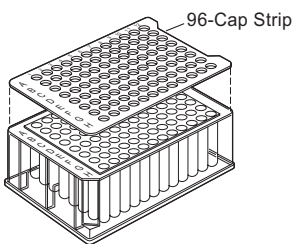

Available sterile or nonsterile 96-cap strips can be used with deep-well plates. (When these caps are used, the capacity of each well is reduced to 1.0 mL.)

Aluminum Foil Lids

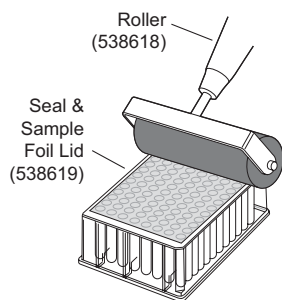

Seal & Sample aluminum foil lids (538619) have a bioinert adhesive backing, enabling complete plate sealing. The lids are presized for multiwell, deep-well, and square-well plates, and cause no reduction in well capacity. A 4-inch soft-rubber roller (538618) is required to ensure secure sealing of the foil lids.

USING ADAPTERS

Tubes and bottles used with adapters can be filled (and capped, if applicable) according to the type of container and the design of the rotor being used.

USING SOLID MULTITUBE ADAPTERS

The solid adapters, available in several tube configurations, can be filled and loaded into rotor buckets or cavities without any preparation. They can also be used as tube racks in the laboratory.

USING MODULAR DISK MULTITUBE ADAPTERS

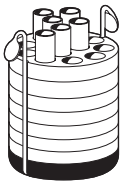

These adapters can also be used as tube racks in the laboratory. The adapter disks are color-coded by the tube size they accommodate; the number of disks used in an adapter assembly depends upon the length of tubes used. Refer to the applicable rotor manual to determine the kind of adapter required for the tubes you are using.

Assemble modular disk adapters as follows.

1. Select the appropriate adapter base and attach a bail to it.
2. Place the base and bail in an empty bucket or on the lab bench (not in the rotor).
3. Position one of the disks so that its grooves are aligned with the bail. Push the disk down until the bail snaps into the grooves.
4. Add more disks until the height of the assembly is nearly as tall as the tubes you will be using. (If the height of the disks is very tall, you may have to push the bail into the grooves of the top disks by hand.) Remove or add disks to the bail to accommodate shorter or longer tubes. If the tubes fit too snugly in the adapter's rubber base, apply a light film of dusting power, such as talcum powder, to prevent the tubes from sticking.

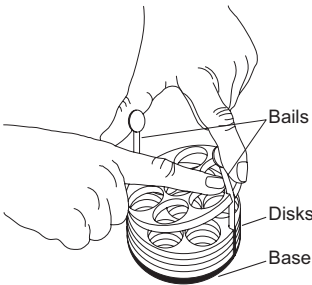

USING AEROSOLVE CANNISTERS

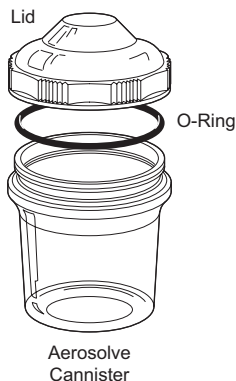

Aerosolve cannisters can be used in the JS-4.3 rotor to minimize aerosol leakage and liquid spills from rotor buckets during centrifugation. Each cannister can hold a variety of tube sizes in tube racks that are specifically designed to fit in the cannisters. The cannister can also be used as a 500-mL wide-mouth bottle.



WARNING

When centrifuging hazardous materials, always open cannisters in an appropriate hood or biological safety cabinet.

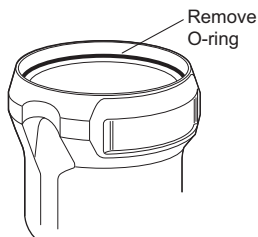

1. Inspect cannister assemblies before use. Do not use damaged components.
2. Before placing the cannister in a bucket, remove the bucket-cover O-ring seated on the ledge inside the bucket. If this O-ring is not removed, a vacuum will be created between the bucket and cannister that will make removing the cannister from the bucket difficult.



NOTE

Do not run chloroformed samples in Aerosolve cannisters. Chloroform vapors can damage the cannister material.

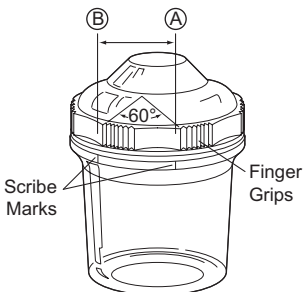

To tighten, turn the lid from (A) to (B). Tightening down the lid more than this will make it difficult to remove.

3. Fill the cannister as described under USING CANNISTERS AS WIDE-MOUTH BOTTLES, or USING CANNISTERS WITH TUBE RACKS, below.
4. Screw the lid on until closing resistance is first felt, then tighten it an additional 60 degrees. The scribe marks around the rim of the cannister and the corrugated finger grips on the lid are all placed 60 degrees apart.

USING CANNISTERS AS WIDE-MOUTH BOTTLES

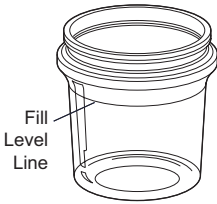

1. Fill each cannister only to the fill-level line (maximum is 500 mL of 1.2 g/mL liquid).
2. Run another cannister, filled to the same level with liquid of the same density, in the opposite bucket.

USING CANNISTERS WITH TUBE RACKS

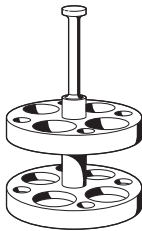

Aerosolve
Tube Rack

The racks designed to hold tubes in the Aerosolve cannister are listed in Table 3-2. Tube racks are easily disassembled by unscrewing the handle and lifting off the top plate.

1. Press a rubber cushion (if applicable—see Table 3-2) into each tube hole in the rack base.
2. Load filled tubes symmetrically into tube racks. Opposing loads should weigh about the same, within 10 grams. Do not exceed the rated maximum load for each bucket (1000 grams). Maximum bucket load includes the bucket, cushion (if applicable), cannister, tube rack, tubes, and sample.

NOTE

Partially filled tube racks should contain the same number of balanced tubes. Each tube in a rack must be balanced by a tube in a diametrically opposed position in the opposite rack.

Table 3-2. Aerosolve Tube Racks

| Rack Color | Nominal Tube Volume (mL) | Nominal Tube Diameter (mm) | Maximum Number Tubes per Adapter | Part Number | | Tube Cushion* Part Number |
|-----------------------|--------------------------|----------------------------|----------------------------------|---------------------|--------------------|---------------------------|
| | | | | (set of four racks) | (set of two racks) | |
| white | 1.5 | 11 | 24 | — | 354495 | none |
| blue | 3 & 5 | 12 | 24 | 359160 | 359482 | 344117 |
| tan | 5 | 13 | 24 | 358993 | 359489 | none |
| orange | 10 | 14 | 18 | 359161 | 359483 | 344118 |
| purple | 12 3 & 5 | 16 12 | 12 6 | 359162 | 359484 | 344119 |
| white (vials) | 15 | 14 | 10 | — | 344517 | none |
| green | 15 & 20 3 & 5 | 18 12 | 12 6 [†] | 359163 | 359485 | 344120 |
| light green (conical) | 15 3 & 5 | 17 12 | 6 6 | 358991 | 359487 | none |
| lime green (conical) | 50 3 & 5 | 30 12 | 4 4 | 358992 | 359488 | none |
| yellow | 50 3 & 5 | 29 12 | 4 4 | 359164 | 359486 | 344121 |

*These cushions are inserted into the tube holes in the base of the rack. An additional pad (part number 349948), inserted in the rotor bucket beneath the entire cannister, is also needed.

[†]If using 15-mL Vacutainers, only four may be loaded into this tube rack (the two outer positions are restricted by the cover height). Vacutainer is a registered trademark of Beckton, Dickinson and Company.

USING BLOOD BAG CUPS



WARNING

Ask your laboratory safety officer to advise you about the level of containment required for your application and about the proper decontamination or sterilization procedures to follow if fluids escape from containers.

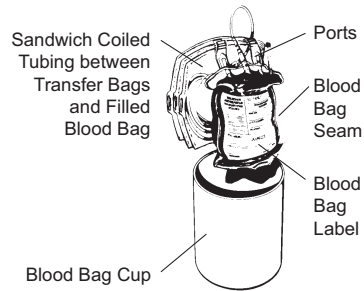

Different cups, color-coded for capacity identification, can accommodate single, double, triple, or quad pack blood bags. Refer to the applicable rotor manual to determine the correct blood bag cup to use. *Do not pour liquid directly into blood bag cups. Fit blood bags into cups before loading the cups into the rotor buckets.* Stuffing blood bags directly into the rotor while it is installed in the centrifuge can trip the imbalance detector.

1. Load the bags as far down into the cups as possible. Make sure the bags stay as vertical as possible, with no folds at the top or corners. If folds are present, blood cells could remain in the folds and then mix with the plasma when the bag is removed.
2. Sandwich the tubing between the blood bag and any transfer packs.
3. Make sure the loaded blood bag cups opposite each other on the rotor yoke are approximately the same weight (within 1 gram). (Balancing pads can be used with some rotors, if necessary, to maintain weight balance.)

Load blood bag cups into the rotor buckets. To reduce the possibility of bag breakage, align the blood bag seam with the rotor pivot pins with the label facing out (away from the axis of rotation).

SAMPLE RECOVERY



CAUTION

If disassembly reveals evidence of leakage, you should assume that some fluid escaped the container or rotor. Apply appropriate decontamination procedures to the centrifuge, rotor, and accessories.

You can recover labware from most J series rotors while the rotor or yoke remains in the centrifuge.

- Rotor buckets or carriers can be removed from the rotor yoke, then unloaded on a lab bench or table or under a protective hood. Blood bags must *always* be removed from blood bag cups outside of the centrifuge.

- You can remove the lid from most fixed angle rotors and extract the tubes or bottles using a removal tool (specified in the applicable rotor manual).

NOTE

Vertical tube rotors cannot be unloaded inside the centrifuge. The rotor must be removed from the centrifuge and placed in a rotor vise to loosen the tube cavity plugs.

Sample recovery depends on the type of labware used, the component(s) isolated, and the analysis desired. The Beckman Universal Fraction Recovery System (343890) can be useful when recovering sample from tubes (see publication L5-TB-081).

CAPPED TUBES



The usual methods of recovering supernatants or pellets include decanting or withdrawing the gradient and scraping pellets from the tube bottom.

- Remove tube caps carefully to avoid sample mixing.
- If tubes will be reused, scrape pellets out with a plastic or wooden tool; scratches on tube interiors caused by abrasive or sharply pointed tools can result in tube failure during subsequent runs.

JS-5.0 CUPS

1. Remove the rotor lid and hang it on the black rubber block on the inside of the centrifuge door.
2. Remove the plug from the labware cup cover and pour the supernatant out of the cup through the spout. Or, remove the cup cover and pour the supernatant over the cup edge.
3. If a liner was used, remove the liner from the cup. Fold or heat seal the liner⁵ and store the pellet as required.

⁵ Beckman Coulter recommends Cole-Parmer heat sealer Model U-03018-10, adjusted to setting 3 or 4. Contact Cole-Parmer at (800) 323-4340, by Fax at (847) 247-2929, or at www.coleparmer.com.



4. If a liner was not used, first remove the red cup gasket (369257), remove the partition (if used), and then use the spatula (367891) to remove pellet from the cup. Do not use a metal tool to remove pellet, as metal could damage the cup and shorten its useful life.

QUICK-SEAL TUBES

There are several methods of recovering fractions from Quick-Seal tubes. One of the following procedures may be used.

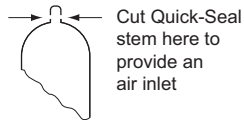

NOTE

If you plan to collect particles from the tube side or bottom, first create an air passage by snipping the stem or inserting a hollow hypodermic needle in the top of the tube.

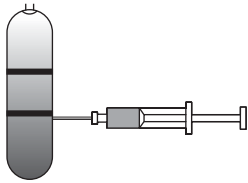

- Puncture the side of the tube just below the band with a needle and syringe and draw the sample off. Take care when piercing the tube to avoid pushing the needle out the opposite side.

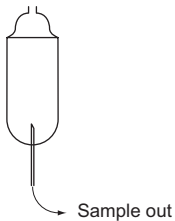

- Puncture the bottom of the tube and collect the drops.

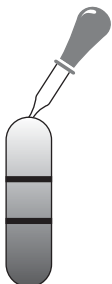

- Aspirate the sample from the tube top by snipping off the tube stem, then aspirating the sample with a Pasteur pipette or needle and syringe.

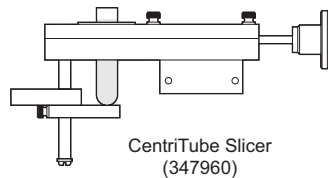

- Slice the tube, using the Beckman CentriTube Slicer (347960). Refer to publication L-TB-010 for instructions for using the CentriTube Slicer.

For additional information on fraction recovery systems available from Beckman Coulter, refer to the latest edition of *High Performance, High Speed, High Capacity Rotors, Tubes & Accessories* (publication BR-8102) available at www.beckmancoulter.com.

MAKING ULTRA-CLEAR TUBES WETTABLE

The following method of making Ultra-Clear tubes wettable has proven successful for some users:

1. Polyvinyl alcohol (2 g) was dissolved in distilled water (50 mL) by stirring and heating to gentle reflux.
2. Isopropanol (50 mL) was slowly added to the hot solution and stirring and heating continued until a clear solution was obtained.
3. The solution was then allowed to cool to room temperature.
4. Ultra-Clear tubes were filled with the coating solution, then aspirated out with a water pump after 15 minutes, leaving a thin film on the tube walls. A small amount of solution that collected in the tube bottoms after standing was removed with a pipette.
5. The tubes were left open to dry at room temperature overnight, then filled with distilled water. After standing overnight at room temperature, the distilled water was poured out.
6. Finally, the tubes were briefly flushed with water, tapped to remove excess liquid, and left to dry.

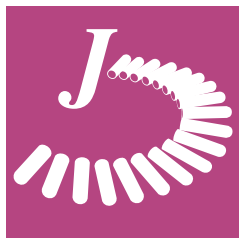

Using Fixed Angle Rotors

This section contains instructions for using fixed angle rotors in J series centrifuges. In addition to these instructions, observe procedures and precautions provided in the applicable rotor and centrifuge manuals.

Refer to Section 2 for labware selection information, and Section 3 for recommended filling and sealing or capping requirements and for sample recovery procedures. Refer to Section 7 for information on the care of rotors and accessories.

DESCRIPTION

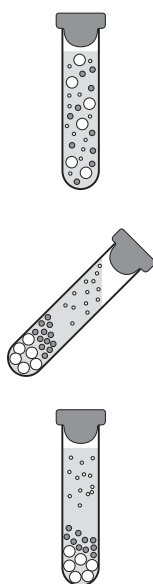

Fixed angle rotors (see Figure 4-1) are general-purpose rotors that are especially useful for pelleting subcellular particles and in short-column banding of viruses and subcellular organelles. Refer to Table 4-1 for general rotor specifications.

Tubes in fixed angle rotors are held at an angle (usually 20 to 45 degrees) to the axis of rotation. The tube angle shortens the particle pathlength compared to swinging bucket rotors, resulting in reduced run times. Tubes can be placed directly in a rotor cavity if the diameters of the tube and the cavity are the same. Using adapters, more than one type and size of tube can be centrifuged together, provided that the load is properly balanced.

O-rings, made of Buna N rubber, are located in the rotor lid. The O-rings help to maintain atmospheric pressure inside a fixed angle rotor during centrifugation, when they are properly lubricated.

A tie-down device or lid-locking knob is used to secure the rotor to the centrifuge drive spindle hub before the run begins.

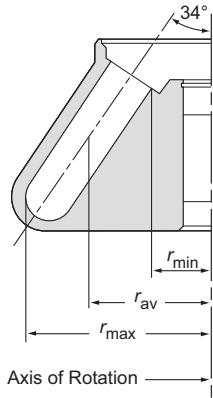

JA-20

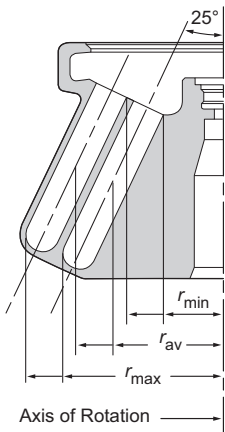

JA-25.15

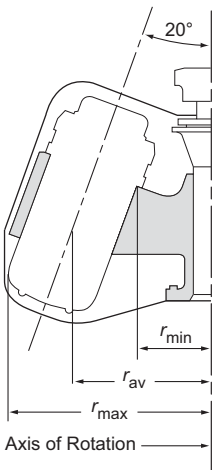

JLA-10.500

Figure 4-1. Examples of Fixed Angle Rotors

Table 4-1. General Specifications for Beckman Coulter J Series Fixed Angle Rotors

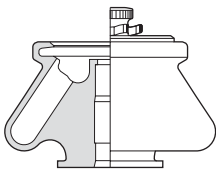
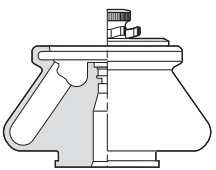
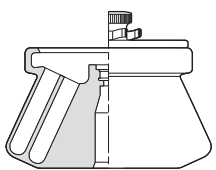
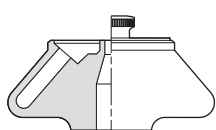
| Rotor Profile and Name | Max Speed ^{a/} RCF/ k Factor | Critical Speed Range ^b (rpm) | Radial Distances (mm) | | | Number of Tubes × Nominal Capacity of Largest Tube | Nominal Rotor Capacity |
|--|--|--|-----------------------|-----------------|--------------|--|------------------------|
| | | | r_{\max} | r_{av} | r_{\min} | | |
|  JA-30.50 Ti (34° Angle) | 30 000 rpm 108 860 × g 280 | 600 to 800 | 108 | 74 | 40 | 8 × 50 mL | 400 mL |
|  JA-25.50 (34° Angle) | 25 000 rpm ^c 75 600 × g 418 | 600 to 800 | 108 | 73.2 | 38.5 | 8 × 50 mL | 400 mL |
|  JA-25.15 (25° Angle) | 25 000 rpm 74 200 × g (outer row) 265 60 200 × g (inner row) 380 | 600 to 800 | 106 86 | 79 59 | 52 32 | 24 × 15 mL | 360 mL |
|  JA-21 (40° Angle) | 21 000 rpm 50 400 × g 470 | 600 to 800 | 102 | 73 | 45 | 18 × 10 mL | 180 mL |

Continued —

^a Maximum speeds are based on a solution density of 1.2 g/mL in all rotors except for the JA-18.1, which is rated for a density of 1.4 g/mL.

^b Critical speed range is the range of speeds over which the rotor shifts so as to rotate about its center of mass. Passing through or running at the critical speed range is characterized by some vibration.

^c Maximum speed in an Avanti J-E centrifuge is 21 000 rpm.

^d When a JA-18.1 rotor is used in the J2-HC centrifuge, derate the rotor as follows: when the 45° adapters are used, do not run the rotor above 15 000 rpm; when 25° adapters are used, do not run the rotor above 16 000 rpm.

^e Maximum speed in an Avanti J series centrifuge, except Avanti J-E; maximum speed in an Avanti J-E for a rotor with magnets, maximum speed for rotor without magnets is 13 000 rpm. Maximum speed in a J2 series centrifuge is 14 000 rpm.

^f Maximum speed in an Avanti J-E for a rotor with magnets, maximum speed for a rotor without magnets is 13 000 rpm.

^g Maximum speed in an Avanti J-E for the rotor with magnets; without magnets maximum is 14 000 rpm. (Maximum speed at 2°C in a 50-Hz centrifuge is 14 000 rpm.)

^h Maximum speed for rotor without magnets in an Avanti J-E centrifuge is 6300 rpm.

ⁱ Do not put bottles directly into the rotor without cannisters.

^j Maximum speed for rotor in an Avanti J-E centrifuge is 6300 rpm.

Table 4-1. General Specifications for Beckman Coulter J Series Fixed Angle Rotors (continued)

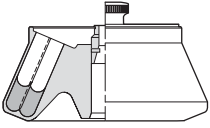
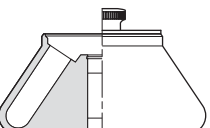
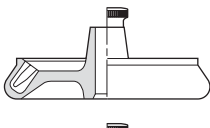
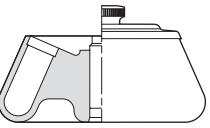
| Rotor Profile and Name | Max Speed ^a / RCF/ k Factor | Critical Speed Range ^b (rpm) | Radial Distances (mm) | | | Number of Tubes × Nominal Capacity of Largest Tube | Nominal Rotor Capacity |
|--|---|---|-----------------------|-----------------|------------|--|------------------------|
| | | | r_{\max} | r_{av} | r_{\min} | | |
|  JA-20.1 (23° Angle) | 20 000 rpm 51 500 × <i>g</i> (outer row) 43 900 × <i>g</i> (inner row) 371 | 600 to 800 | 115 98 | 107 73 | 64 47 | 32 × 15 mL | 480 mL |
|  JA-20 (34° Angle) | 20 000 rpm 48 400 × <i>g</i> 770 | 600 to 800 | 108 | 70 | 32 | 8 × 50 mL | 400 mL |
|  JA-18.1 (45° Angle Adapter) or (25° Angle Adapter) | 18 000 rpm ^d 42 100 × <i>g</i> 156 17 000 rpm ^d 36 300 × <i>g</i> 91 | 600 to 800 | 116 112 | 105 106 | 95 101 | 24 × 1.8 mL 24 × 1.8 mL | 43.2 mL 43.2 mL |
|  JA-18 (23° Angle) | 18 000 rpm ^e 47 900 × <i>g</i> 566 | 600 to 800 | 132 | 98 | 64 | 10 × 100 mL | 1 liter |

Continued —

^a Maximum speeds are based on a solution density of 1.2 g/mL in all rotors except for the JA-18.1, which is rated for a density of 1.4 g/mL.

^b Critical speed range is the range of speeds over which the rotor shifts so as to rotate about its center of mass. Passing through or running at the critical speed range is characterized by some vibration.

^c Maximum speed in an Avanti J-E centrifuge is 21 000 rpm.

^d When a JA-18.1 rotor is used in the J2-HC centrifuge, derate the rotor as follows: when the 45° adapters are used, do not run the rotor above 15 000 rpm; when 25° adapters are used, do not run the rotor above 16 000 rpm.

^e Maximum speed in an Avanti J series centrifuge, except Avanti J-E; maximum speed in an Avanti J-E for a rotor with magnets, maximum speed for rotor without magnets is 13 000 rpm. Maximum speed in a J2 series centrifuge is 14 000 rpm.

^f Maximum speed in an Avanti J-E for a rotor with magnets, maximum speed for a rotor without magnets is 13 000 rpm.

^g Maximum speed in an Avanti J-E for the rotor with magnets; without magnets maximum is 14 000 rpm. (Maximum speed at 2°C in a 50-Hz centrifuge is 14 000 rpm.)

^h Maximum speed for rotor without magnets in an Avanti J-E centrifuge is 6300 rpm.

ⁱ Do not put bottles directly into the rotor without cannisters.

^j Maximum speed for rotor in an Avanti J-E centrifuge is 6300 rpm.

Table 4-1. General Specifications for Beckman Coulter J Series Fixed Angle Rotors (continued)

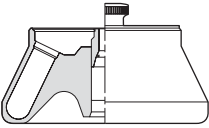
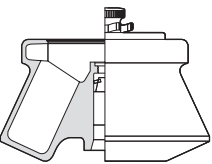
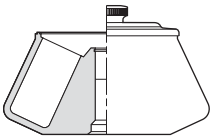
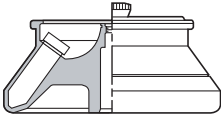
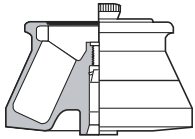
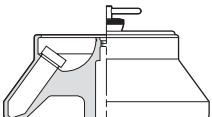
| Rotor Profile and Name | Max Speed ^{a/} RCF/ k Factor | Critical Speed Range ^b (rpm) | Radial Distances (mm) | | | Number of Tubes × Nominal Capacity of Largest Tube | Nominal Rotor Capacity |
|--|---|--|-----------------------|-----------------|------------|--|------------------------|
| | | | r_{\max} | r_{av} | r_{\min} | | |
|  JA-17 (25° Angle) | 17 000 rpm ^f 39 800 × <i>g</i> 690 | 600 to 800 | 123 | 90 | 56 | 14 × 50 mL | 700 mL |
|  JLA-16.250 (25° Angle) | 16 000 rpm ^g 38 400 × <i>g</i> 1 090 | 600 to 800 | 134 | 90 | 46 | 6 × 250 mL | 1.5 liter |
|  JA-14 (25° Angle) | 14 000 rpm 30 100 × <i>g</i> 1 764 | 600 to 800 | 137 | 86 | 35 | 6 × 250 mL | 1.5 liter |
|  F14BCI-14x50cy (34° Angle) | 14 000 rpm 33 500 × <i>g</i> 789 | 600 to 1 200 | 153 | 118 | 83 | 14 × 50 mL | 700 mL |
|  F14BCI-6x250y (23° Angle) | 14 000 rpm 30 000 × <i>g</i> 1 690 | 600 to 1 200 | 137 | 87 | 37 | 6 × 250 mL | 1 500 mL |
|  JA-12 (35° Angle) | 12 000 rpm 23 200 × <i>g</i> 1 244 | 400 to 1 000 | 144 | 108 | 71 | 12 × 50 mL | 600 mL |

Continued —

^a Maximum speeds are based on a solution density of 1.2 g/mL in all rotors except for the JA-18.1, which is rated for a density of 1.4 g/mL.

^b Critical speed range is the range of speeds over which the rotor shifts so as to rotate about its center of mass. Passing through or running at the critical speed range is characterized by some vibration.

^c Maximum speed in an Avanti J-E centrifuge is 21 000 rpm.

^d When a JA-18.1 rotor is used in the J2-HC centrifuge, derate the rotor as follows: when the 45° adapters are used, do not run the rotor above 15 000 rpm; when 25° adapters are used, do not run the rotor above 16 000 rpm.

^e Maximum speed in an Avanti J series centrifuge, except Avanti J-E; maximum speed in an Avanti J-E for a rotor with magnets, maximum speed for rotor without magnets is 13 000 rpm. Maximum speed in a J2 series centrifuge is 14 000 rpm.

^f Maximum speed in an Avanti J-E for a rotor with magnets, maximum speed for a rotor without magnets is 13 000 rpm.

^g Maximum speed in an Avanti J-E for the rotor with magnets; without magnets maximum is 14 000 rpm. (Maximum speed at 2°C in a 50-Hz centrifuge is 14 000 rpm.)

^h Maximum speed for rotor without magnets in an Avanti J-E centrifuge is 6300 rpm.

ⁱ Do not put bottles directly into the rotor without cannisters.

^j Maximum speed for rotor in an Avanti J-E centrifuge is 6300 rpm.

Table 4-1. General Specifications for Beckman Coulter J Series Fixed Angle Rotors (continued)

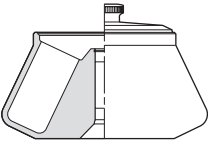
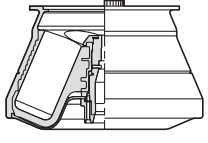
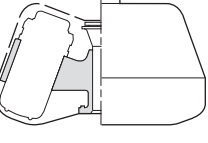
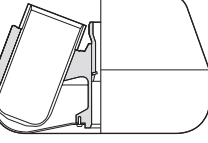
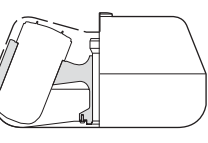
| Rotor Profile and Name | Max Speed ^a / RCF/ k Factor | Critical Speed Range ^b (rpm) | Radial Distances (mm) | | | Number of Tubes × Nominal Capacity of Largest Tube | Nominal Rotor Capacity |
|--|--|--|-----------------------|-----------------|------------|--|------------------------|
| | | | r_{\max} | r_{av} | r_{\min} | | |
|  JA-10 (25° Angle) | 10 000 rpm 17 700 × g 3 610 | 600 to 800 | 158 | 98 | 38 | 6 × 500 mL | 3 liters |
|  F10BCI- 6x500y (23° Angle) | 10 000 rpm 17 696 × g 3 417 | 600 to 1 200 | 158 | 100 | 41 | 6 × 500 mL | 3 liters |
|  JLA-10.500 ⁱ (20° Angle) | 10 000 rpm ^h 18 600 × g 2 850 | 600 to 800 | 166 | 110 | 64 | 6 × 500 mL | 3 liters |
|  JLA-9.1000 ⁱ (20° Angle) (use only in Avanti J series centrifuges) | 9 000 rpm ⁱ 16 800 × g 2 540 | 200 to 400 | 185 | 134 | 82 | 4 × 1000 mL | 4 liters |
|  JLA-8.1000 ⁱ (20° Angle) (use only in Avanti J-26XP, J-HC, and discontinued Avanti J-20 series centrifuges) | 8 000 rpm 15 900 × g 2 500 | 200 to 400 | 222.8 | 171 | 119 | 6 × 500 mL | 6 liters |

^a Maximum speeds are based on a solution density of 1.2 g/mL in all rotors except for the JA-18.1, which is rated for a density of 1.4 g/mL.

^b Critical speed range is the range of speeds over which the rotor shifts so as to rotate about its center of mass. Passing through or running at the critical speed range is characterized by some vibration.

^c Maximum speed in an Avanti J-E centrifuge is 21 000 rpm.

^d When a JA-18.1 rotor is used in the J2-HC centrifuge, derate the rotor as follows: when the 45° adapters are used, do not run the rotor above 15 000 rpm; when 25° adapters are used, do not run the rotor above 16 000 rpm.

^e Maximum speed in an Avanti J series centrifuge, except Avanti J-E; maximum speed in an Avanti J-E for a rotor with magnets, maximum speed for rotor without magnets is 13 000 rpm. Maximum speed in a J2 series centrifuge is 14 000 rpm.

^f Maximum speed in an Avanti J-E for a rotor with magnets, maximum speed for a rotor without magnets is 13 000 rpm.

^g Maximum speed in an Avanti J-E for the rotor with magnets; without magnets maximum is 14 000 rpm. (Maximum speed at 2°C in a 50-Hz centrifuge is 14 000 rpm.)

^h Maximum speed for rotor without magnets in an Avanti J-E centrifuge is 6300 rpm.

ⁱ Do not put bottles directly into the rotor without cannisters.

^j Maximum speed for rotor in an Avanti J-E centrifuge is 6300 rpm.

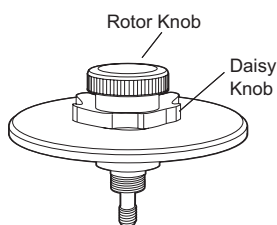

Some rotors have dual-locking lid mechanisms consisting of a daisy knob that secures the lid to the rotor, and a round rotor knob that attaches the rotor to the centrifuge drive spindle hub. (Daisy refers to the knob shape. The grooves between each “petal” let your fingers grip the knob firmly and provide leverage for turning.) The dual-locking capability provides added biosafety by allowing the rotor to be loaded into and removed from the centrifuge with the lid in place. The rotor may be placed under a safety hood before the lid is attached or removed.

**CAUTION**

Always loosen the rotor knob before loosening the daisy knob to avoid jamming the knobs.

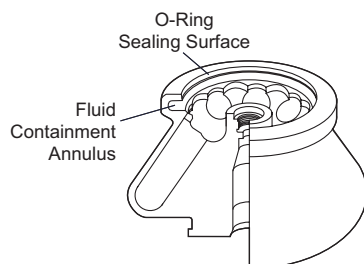

A feature of many Beckman Coulter fixed angle rotors is a patented fluid-containment annulus, located below the O-ring sealing surface. If tubes are overfilled or if leakage occurs during centrifugation, the annulus holds enough volume that all of the liquid is kept inside the rotor—even if all tubes leak at the same time. This feature virtually eliminates the escape of liquid into the centrifuge chamber.

**NOTE**

Although rotor components and accessories made by other manufacturers may fit in the Beckman Coulter rotor you are using, their safety in the rotor cannot be ascertained by Beckman Coulter. Use of other manufacturers' components or accessories in the Beckman Coulter rotor may void the rotor warranty, and should be prohibited by your laboratory safety officer. Only the components and accessories listed in the applicable rotor manual should be used.

TUBES AND BOTTLES

Fixed angle rotors can accommodate a variety of tube types, listed in the rotor manual. Refer to Section 3 for tube filling and sealing requirements. Observe the maximum rotor speeds and fill volumes listed in the rotor manual.

NOTE

JLA-8.1000 and JLA-9.1000 rotors run only the specially designed bottles with polycarbonate seals and Radel cap/closures. Refer to the applicable rotor manual for instructions on use of these bottles and accessories.

ROTOR PREPARATION AND LOADING

For runs at other than room temperature, refrigerate or warm the rotor beforehand for fast equilibration.

PRERUN SAFETY CHECKS



Read all safety information in the rotor manual before using the rotor.

1. Make sure that the rotor and lid are clean and show no signs of corrosion or cracking.
2. Check the chemical compatibilities of all materials used. (Refer to Appendix A.)
3. Verify that the tubes and bottles being used are listed in the applicable rotor manual.
4. If fluid containment is required, *use capped tubes or bottles*. We strongly recommend capping all containers carrying physiological fluids to prevent leakage.

ROTOR PREPARATION

1. Be sure that metal threads in the rotor are clean and lightly but evenly lubricated with Spinkote™ lubricant (306812). Also ensure that O-rings are lightly but evenly coated with silicone vacuum grease (335148).

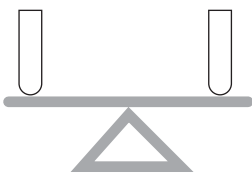

2. Load the filled containers symmetrically into the rotor. Opposing tubes must be filled to the same level with liquid of the same density. Refer to ROTOR BALANCE in Section 1.

OPERATION

Refer to the applicable centrifuge instruction manual for detailed operating information. For low-temperature runs, precool the rotor in the centrifuge or in a refrigerator before use—especially before short runs—to ensure that the rotor reaches the set temperature. (To ensure that the rotor reaches the required temperature during centrifugation, some temperature compensation may be required because of the mass of these rotors. Refer to Appendix B or to the applicable rotor manual for tables listing temperature compensation units for various rotors.)

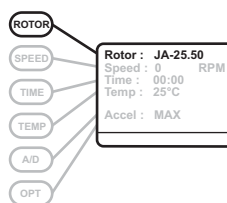

ROTOR

- If you are using an Avanti J series centrifuge (except J-E), select the rotor number.
- If you are using an Avanti J-E or a microprocessor-controlled J2 or J6 series centrifuge, enter the rotor code (if the JA-10 rotor is used for example, enter code **10**).

INSTALLING THE ROTOR



CAUTION

The centrifuge drive spindle can be bent or broken if the rotor is forced sideways or dropped onto it. Install the rotor by centering it over the spindle and carefully lowering it straight down.

1. Carefully lower the rotor straight down onto the drive spindle. Rotate it by hand until the drive pins seat on the drive spindle hub.

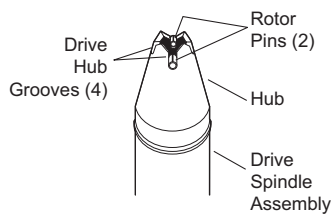

Older Model Centrifuges

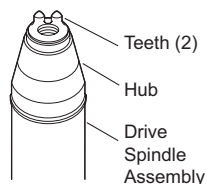

Newer Model Centrifuges

- In *older model centrifuges*—be sure the pins in the rotor drive hole are located in the grooves of the drive spindle hub.

- In *newer model centrifuges*—be sure the pins in the rotor drive hole are not sitting on top of the teeth on the drive spindle hub.



CAUTION

The pins located in the rotor drive hole must be seated correctly on the centrifuge drive spindle. Running a rotor that is not seated properly may result in severe rotor damage.

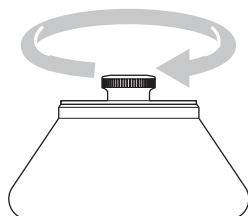

2. After the rotor is seated on the drive spindle hub, place the lid on the rotor.
3. Press down on the knob, then screw it down *tight*. (Turning the knob to the right [clockwise] attaches the rotor to the hub; the lid on some fixed angle rotors remains free and may be slipped on or off while the rotor remains secured in the centrifuge.)



NOTE

The JA-18 rotor *must be run with the lid on* in Avanti J series centrifuges.

REMOVAL AND SAMPLE RECOVERY



CAUTION

If disassembly reveals evidence of leakage, you should assume that some fluid escaped the container or rotor. Apply appropriate decontamination procedures to the centrifuge, rotor, and accessories.

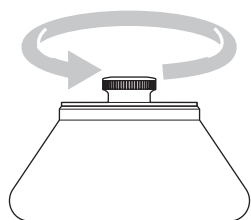

1. Unscrew the rotor lid knob to release the rotor from the spindle hub.

NOTE

Labware can be recovered from most fixed angle rotors while the rotor remains in the centrifuge. You can remove the lid and extract the tubes or bottles using the removal tool specified in the applicable rotor manual. If the rotor is left in the centrifuge between runs, be sure that it is securely tied down before each run. Remove the rotor regularly and clean the drive spindle assembly.

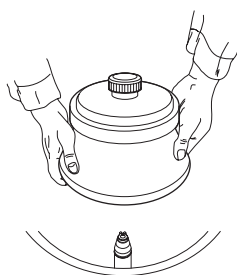

2. To remove the rotor, lift it straight up and off the drive spindle.

NOTE

If the rotor sticks to the drive spindle, screw the short end of the rotor lifting handle assembly into the threaded opening to force the rotor off of the drive spindle hub. Lubrication of the centrifuge drive spindle hub with Spinkote should prevent the rotor from sticking on all centrifuges except Avanti J series. Avanti J series centrifuges have Delrin rings on the spindle hubs to prevent sticking and do not require lubrication.

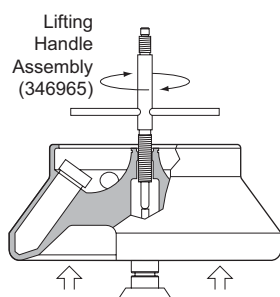

3. Remove spacers, tubes, and bottles with the appropriate removal tool.



Quick-Seal Tube
Removal Tool
(361668)

4. Refer to Section 3 for sample recovery methods.

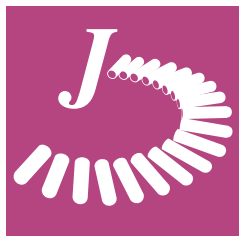

Using Swinging Bucket Rotors

This section contains instructions for using swinging bucket rotors in J series centrifuges. In addition to these instructions, observe procedures and precautions provided in the applicable rotor and centrifuge manuals.

Refer to Section 2 for tube selection information, and Section 3 for recommended labware filling and sealing requirements and for sample recovery procedures. Refer to Section 7 for information on the care of rotors and accessories.

DESCRIPTION

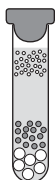
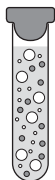

Swinging bucket rotors (see Figure 5-1) are normally used for density gradient separations, either isopycnic or rate zonal. Refer to Table 5-1 for general rotor specifications. A tie-down device or lid-locking knob is used to lock the rotor to the centrifuge drive hub before the run begins.

Tubes or bottles in swinging bucket rotors are held in the rotor buckets that are attached to the rotor body by hinge pins. The buckets swing out to horizontal position as the rotor is accelerated, and stay horizontal until rotor deceleration begins. During deceleration, the buckets gradually return to vertical position.

NOTE

Although rotor components and accessories made by other manufacturers may fit in the Beckman Coulter rotor you are using, their safety in the rotor cannot be ascertained by Beckman Coulter. Use of other manufacturers' components or accessories in the rotor may void the rotor warranty, and should be prohibited by your laboratory safety officer. Only the components and accessories listed in the applicable rotor manual should be used.

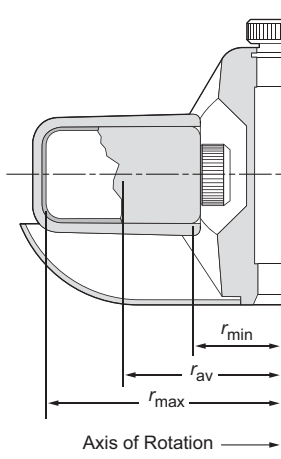

JS-7.5

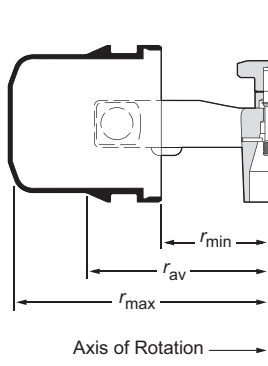

JS-4.3

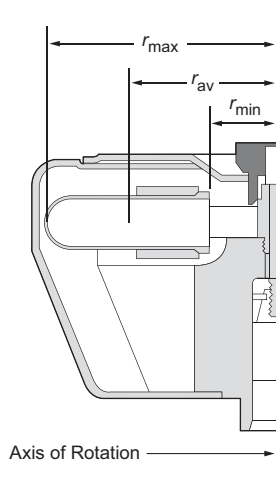

JS-13.1

Figure 5-1. Examples of Swinging Bucket Rotors

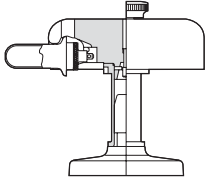
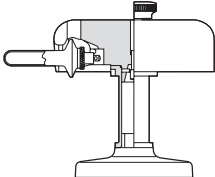
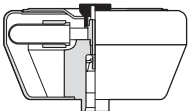
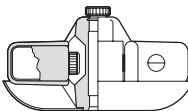
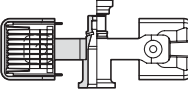
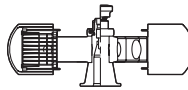
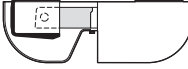
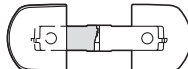
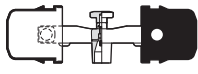
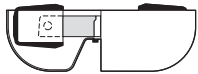

Table 5-1. General Specifications for Beckman Coulter J Series Swinging Bucket Rotors

| Rotor Profile and Name | Max Speed*/ RCF/ k Factor | Critical Speed Range† (rpm) | Radial Distances (mm) | | | Number of Tubes × Nominal Capacity of Largest Tube | Nominal Rotor Capacity |
|--|--|--------------------------------------|-----------------------|--------------------|-------------------|--|------------------------------|
| | | | r_{\max} | r_{av} | r_{\min} | | |
|  JS-24.38 | 24 000 rpm $110\,500 \times g$ 334 | N/A | 161.0 | 118.2 | 75.3 | 6 × 38.5 mL | 231 mL |
|  JS-24.15 | 24 000 rpm $103\,900 \times g$ 376 | N/A | 171.3 | 122.1 | 72.9 | 6 × 15 mL | 90 mL |
|  JS-13.1 | 13 000 rpm $26\,500 \times g$ 1841 | 400 to 1450 | 140 | 91 | 41 | 6 × 50 mL | 300 mL |
|  JS-7.5 | 7500 rpm $10\,400 \times g$ 1090 | 600 to 800 | 165 | 108 | 51 | 4 × 250 mL | 1 liter |
|  JS-5.9 | 5900 rpm $6570 \times g$ | 500 to 1200 | 194.8 | 179.6 | 164.3 | 10 microplates 4 deep-well plates 2 squarewell plates | 384 mL |
|  JS-5.3 | 5300 rpm $6130 \times g$ (deep-well plates) $6870 \times g$ (500-mL bottles) | 500 to 1200 | 168.5 218.4 | 153.4 155.6 | 138.6 92.7 | 24 microplates 8 deep-well plates 4 square well-plates 4 × 500 mL | 768 mL 2 liters |
|  JS-5.2 | 5200 rpm $6840 \times g$ 9051 | 600 to 800 | 226 | 156 | 86 | 4 × 1 liter 4 blood bags 12 microplates 148 RIA tubes | 4 liters |
|  JS-5.0 | 5000 rpm $7480 \times g$ 9171 | 300 to 600 | 267 | 188 | 108 | 4 × 2.25 liters | 9 liters |

*Maximum speeds are based on a solution density of 1.2 g/mL.

†Critical speed range is the range of speeds over which the rotor shifts so as to rotate about its center of mass. Passing through or running at the critical speed range is characterized by some vibration.

Table 5-1. General Specifications for Beckman Coulter J Series Swinging Bucket Rotors (continued)

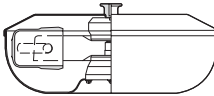
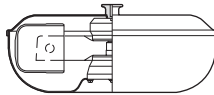
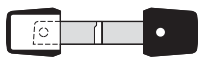
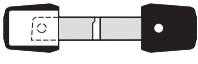
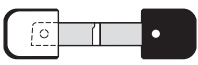
| Rotor Profile and Name | Max Speed*/ RCF/ k Factor | Critical Speed Range† (rpm) | Radial Distances (mm) | | | Number of Tubes × Nominal Capacity of Largest Tube | Nominal Rotor Capacity |
|--|--------------------------------|-----------------------------|---------------------------------|-----------------|------------------|--|------------------------|
| | | | r _{max} | r _{av} | r _{min} | | |
|  JS-4.3 | 4300 rpm 4220 × g 16 635 | 400 to 1450 | 204 (buckets) 163 (carriers) | | | 4 × 750 mL 4 blood bags 12 microplates 148 RIA tubes | 3 liters |
|  JS-4.2 | 4200 rpm 5020 × g 11 502 | 600 to 800 | 254 | 184 | 114 | 6 × 1 liter 6 blood bags 18 microplates 336 RIA tubes | 6 liters |
|  JS-4.2SM (use only in J6 series centrifuges) | 4200 rpm 4900 × g | 600 to 800 | 248 | 182 | 116 | 6 triple or quad pack blood bags | 6 liters |
|  JS-4.2A | 4200 rpm 5020 × g 11 502 | 600 to 800 | 254 | 184 | 114 | 6 × 1 liter 6 blood bags 18 microplates 336 RIA tubes | 6 liters |
|  JS-4.2SMA (use only in J6 series centrifuges) | 4200 rpm 4900 × g | 600 to 800 | 248 | 182 | 116 | 6 triple or quad pack blood bags | 6 liters |
|  JS-4.0 | 4000 rpm 4044 × g 15 296 | 600 to 800 | 226 | 156 | 86 | 4 × 1 liter 4 blood bags 12 microplates 148 RIA tubes | 4 liters |
|  JS-3.0 | 3000 rpm 2560 × g 22 548 | 600 to 800 | 254 | 184 | 114 | 6 × 1 liter 6 blood bags 18 microplates 336 RIA tubes | 6 liters |
|  JS-2.9 | 2900 rpm 2500 × g 24 400 | 600 to 800 | 265 | 192 | 118 | 12 × 500 mL blood bags | 6 liters |

* Maximum speeds are based on a solution density of 1.2 g/mL.

† Critical speed range is the range of speeds over which the rotor shifts so as to rotate about its center of mass. Passing through or running at the critical speed range is characterized by some vibration.

LABWARE

Swinging bucket rotors can accommodate a variety of tubes, bottles, multiwell titer plates, and blood bags, listed in individual rotor manuals. Refer to Section 3 for tube filling and sealing requirements. Observe the maximum rotor speeds and fill volumes listed in the applicable rotor manual.

ROTOR PREPARATION AND LOADING

For runs at other than room temperature, refrigerate or warm the rotor beforehand for fast equilibration.

PRERUN SAFETY CHECKS



Read all safety information in the rotor manual before using the rotor.

1. Make sure that the rotor and buckets or carriers are clean and show no signs of corrosion or cracking.
2. Check the chemical compatibilities of all materials used. (Refer to Appendix A.)
3. Verify that the tubes, bottles, or carriers being used are listed in the applicable rotor manual.
4. If fluid containment is required, *use capped tubes or bottles and/or Aerosolve cannisters*. We strongly recommend capping all containers carrying physiological fluids to prevent leakage.

ROTOR PREPARATION

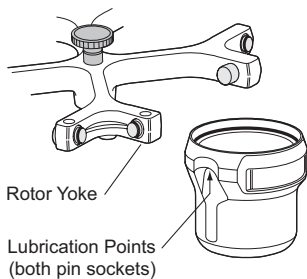

1. Be sure that metal threads in the rotor yoke are clean and lightly but evenly lubricated with Spinkote™ lubricant (306812).
2. Ensure that O-rings are in good condition and are lightly but evenly coated with silicone vacuum grease (335148).
3. Ensure that all sealing surfaces are smooth and undamaged for proper sealing.
4. Before each use of the rotor, make sure that bucket pin sockets are lubricated with Paint On Graphite Lubricant (977212) as described in Section 7.

Special Preparation Instructions for JS-24 Series Rotors

Place the rotor on the rotor stand (362785) when it is not in the centrifuge.

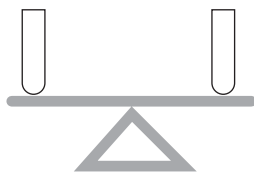
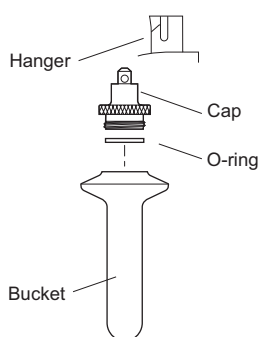

1. Load the filled containers into the buckets. Complete loading by placing the correct floating spacers (if required) over the tubes.
2. Ensure that bucket O-rings are lightly but evenly coated with silicone vacuum grease. Do not run a bucket without an O-ring, as the bucket will leak.
3. Be sure that metal threads in the bucket caps are clean and lightly but evenly lubricated with Spinkote™ lubricant. Put bucket caps on the buckets and screw them down manually.
4. *Hook all buckets, loaded or empty, on to the rotor, and be sure that both hooks are on the crossbar. All six buckets must be in the same size. Do not intermix the smaller and larger buckets in a single run. If fewer than six tubes are being run they must be arranged symmetrically in the rotor. Opposing tubes must be filled to the same level with liquid of the same density.*

LOADING THE ROTOR YOKE

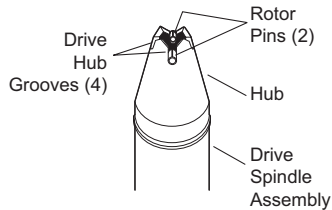

Older Model Centrifuges

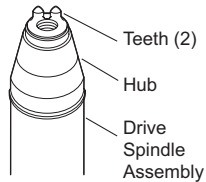

Newer Model Centrifuges

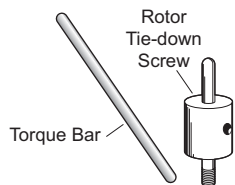
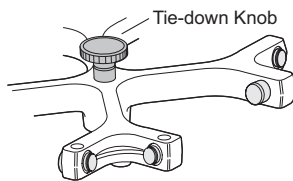
**CAUTION**

The centrifuge drive spindle can be bent or broken if the rotor is forced sideways or dropped onto it. Install the rotor by centering it over the spindle and carefully lowering it straight down.

1. Carefully lower the rotor yoke straight down onto the drive spindle. Rotate it by hand until the drive pins seat on the drive spindle hub.

**NOTE**

Except for the JS-24.38 and JS-24.15 rotors, you can leave the rotor yoke in the centrifuge between runs unless spillage has occurred—in which case you should remove the buckets or carriers and yoke and clean the centrifuge and rotor components immediately, according to the instructions in the centrifuge and rotor instruction manuals. The JS-24.38 and JS-24.15 rotors must be removed from the centrifuge to install or remove buckets.

2. When the yoke is correctly seated, secure it to the drive spindle hub.

- Rotors *with* tie-down knobs—hand tighten the tie-down knob. If the rotor is left in the centrifuge between runs, tighten the knob before each run.
- Rotors *without* tie-down knobs—secure the rotor with the tie-down screw, and tighten the screw with the torque bar or tie-down tool. If the rotor is left in the centrifuge between runs, ensure that the screw is *tight* before each run.

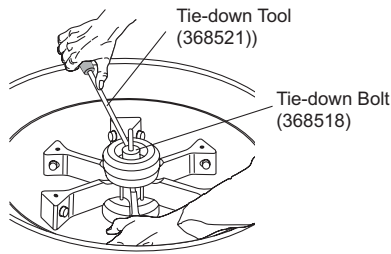

- JS-4.2A and JS-4.2SMA—secure the rotor to the drive hub with the tie-down bolt (368518). Tighten the bolt with the tie-down tool (368521), then remove the tool.

NOTE

Older JS-4.2A or JS-4.2SMA rotors may be secured to the drive hub with tie down bolt (339031). Tighten the bolt with the spanner wrench (870666) or tie-down tool (368521), then remove the wrench or tool.

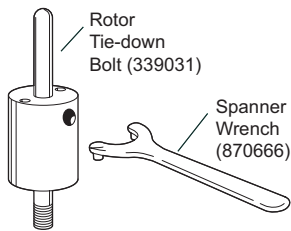

- JS-5.0—secure the rotor to the drive hub with the tie-down bolt (367824). Tighten the bolt with the tie-down tool (368521), then remove the tool.

Loading JS-24 Series Rotors

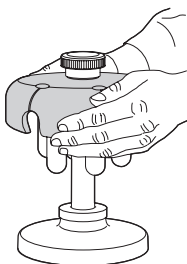

1. To install the rotor, carefully lift it up off the rotor stand with both hands—do not lift the rotor by the adapter—and place it on the drive hub. Make sure that the rotor pins are perpendicular to the drive hub pins. The pins must not rest on top of each other; turn the rotor to the right (clockwise) by hand to check for proper installation.
2. Turn the tie-down knob to the right (clockwise) to secure the rotor.

SYMMETRIC AND BALANCED LOADING

To ensure optimal performance and stability, *swinging bucket rotors must be loaded symmetrically*. Two factors affect symmetric loading:

- The buckets or carriers must be loaded symmetrically with respect to their pivotal axes (the pivotal axis runs parallel to the crossbar, see Figure 5-2).
- The rotor should be loaded symmetrically with respect to its center of rotation.

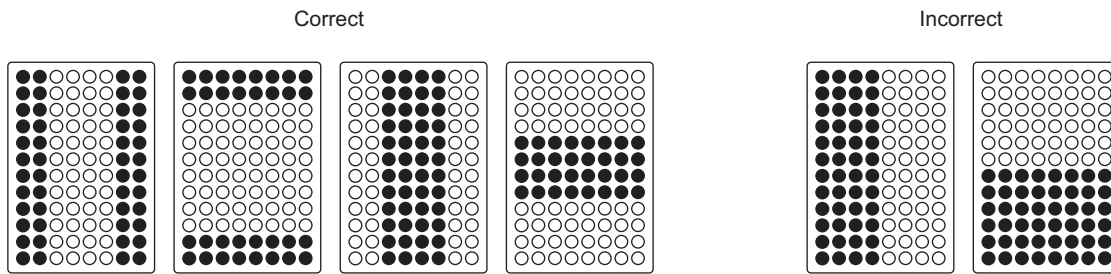
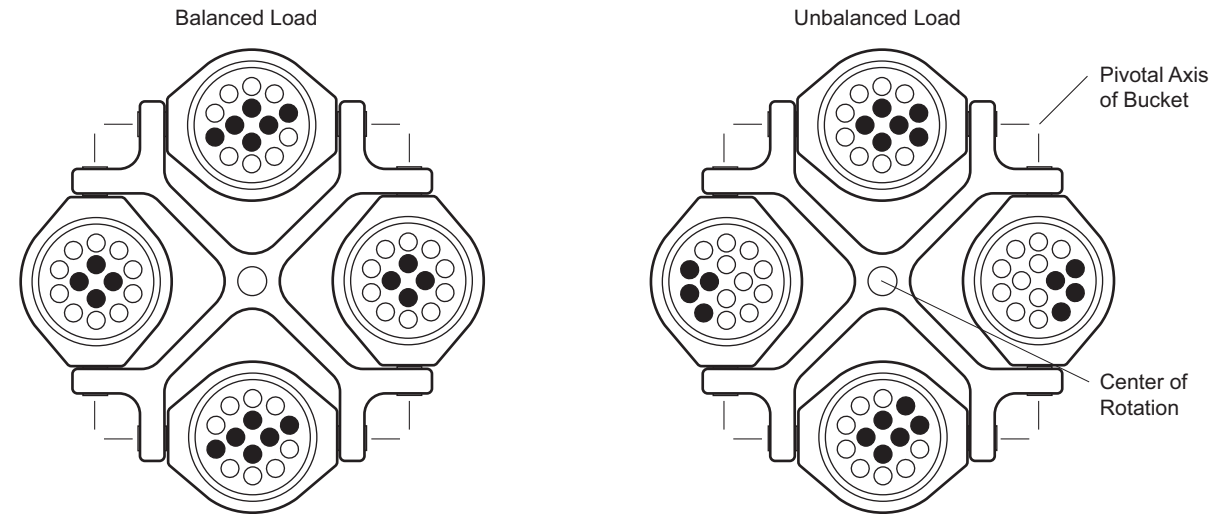

Examples of Symmetrically Loaded Trays
(Load Opposite Trays the Same Way)

Examples of Nonsymmetrically Loaded Trays

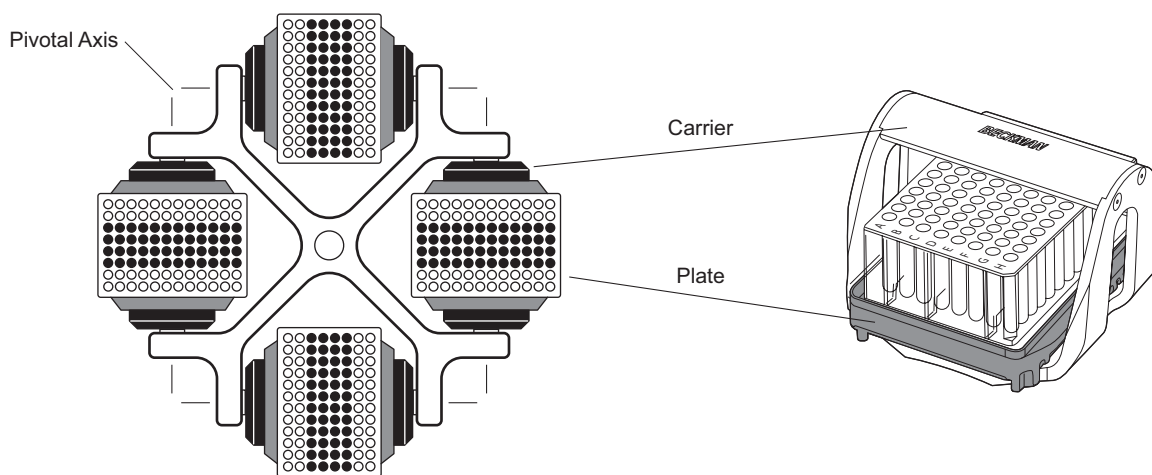

Figure 5-2. Examples of Correctly and Incorrectly Loaded Buckets and Carriers.
Contents of opposing buckets must be the same and each bucket must be balanced on its pivotal axis.

This means that for best results you should load opposing buckets or carriers with the same type of labware containing the same amounts of fluid of equal density. Additionally, buckets or carriers placed opposite each other on the rotor yoke must balance to within a certain weight, typically 10 grams (see the applicable rotor manual for details). Do not exceed the rated maximum load for buckets or carriers.

NOTE

The JS-4.2A and JS-4.2SMA swinging bucket rotors incorporate ARIES (Automated Rotor Imbalance Equilibrating System) “Smart Balance” technology, which provides imbalance compensation for rotors with buckets that are up to 100 grams unbalanced due to different loading volumes or tube or bag breakage.

Beckman Coulter supplies buckets and carriers for most rotors in weight-matched sets to make balancing easier (the weight and date of manufacture are marked on the side of each bucket and bottom of each carrier). Modular disk adapters are also sold in weight-matched sets. However, there are variances in weight between sets, as well as variance in weight between previously purchased adapters. To prevent accidental imbalance, it is important to keep matched sets of adapters together and to weigh other adapters to be sure they are approximately the same. Marking matched sets will help you keep them together.

It is not necessary to completely fill all tubes, positions in adapters, or wells in microtiter plates; however, partially filled adapters or microtiter plates must be balanced with respect to the pivotal axis of the bucket or carrier as discussed below.

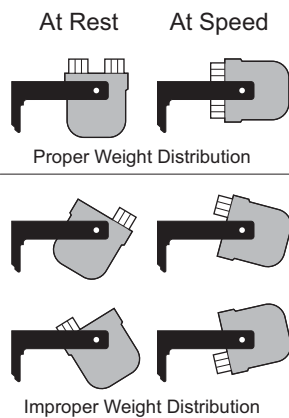

During a run, buckets and carriers swing 90 degrees from their at-rest position. The pivotal axis of a bucket or carrier can be imagined as a line extending across the bucket or carrier from one pivot pin to the other. If a bucket or carrier is loaded so that its weight is unequally distributed on either side of its pivotal axis, it will not hang vertically at rest and, more importantly, may not swing to a horizontal position during a run. As a result, extra stress will be placed on the bucket, carrier, tubes, and/or microtiter plates during the run, increasing the possibility of breakage or rotor imbalance.

LOADING BUCKETS

Buckets can be loaded before or after being installed on the rotor yoke. For best results, fill the appropriate labware first and then load the labware into the buckets. This is especially important when using blood bags—you can trip the imbalance detector in the centrifuge by pushing blood bags into cups within buckets that are installed in the rotor. You can also bend the centrifuge drive spindle.

Using Modular Disk Adapters

Assemble modular disk adapters as follows.

1. Select the appropriate adapter base and attach a bail to it.
2. Place the base and bail in an empty bucket or on the lab bench (not in the rotor).
3. Position one of the disks so that its grooves are aligned with the bail. Push the disk down until the bail snaps into the grooves.
4. Add more disks until the height of the assembly is nearly as tall as the tubes you will be using. (If the height of the disks is very tall, you may have to push the bail into the grooves of the top disks by hand.) Remove or add disks to the bail to accommodate shorter or longer tubes. If the tubes fit too snugly in the adapter's rubber base, apply a light film of dusting powder, such as talcum powder, to prevent the tubes from sticking.

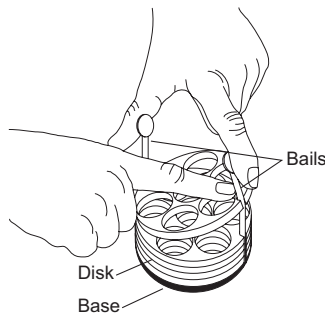

Place each tube in an adapter so that its weight is balanced by a tube in a diametrically opposite position across the pivotal axis in the same adapter. Adapters placed in opposing buckets should also be filled the same way (see Figure 5-2). If you must run only one tube in an adapter, be sure this tube rests over the bucket's pivotal axis.

NOTE

Be sure to run a tube of the same approximate weight in the same configuration in the opposite bucket.

Using Blood Bag Cups

Do not pour liquid directly into blood bag cups. Fit blood bags into cups before loading the cups into the rotor buckets. Load the blood bag cups as follows:

1. Load the cups so that the blood bags and tubing fit as far down as possible.

NOTE

Make sure the bags stay as vertical as possible, with no folds at the top or corners. If folds are present, blood cells could remain in the folds and then mix with the plasma when the bag is removed.

2. Sandwich the tubing between the blood bag and any transfer packs (see Figure 5-3).
3. Make sure the loaded blood bag cups opposite each other on the rotor yoke are approximately the same weight (within limits listed in the applicable rotor manual). In some rotors, balancing pads can be used if necessary to maintain weight balance.

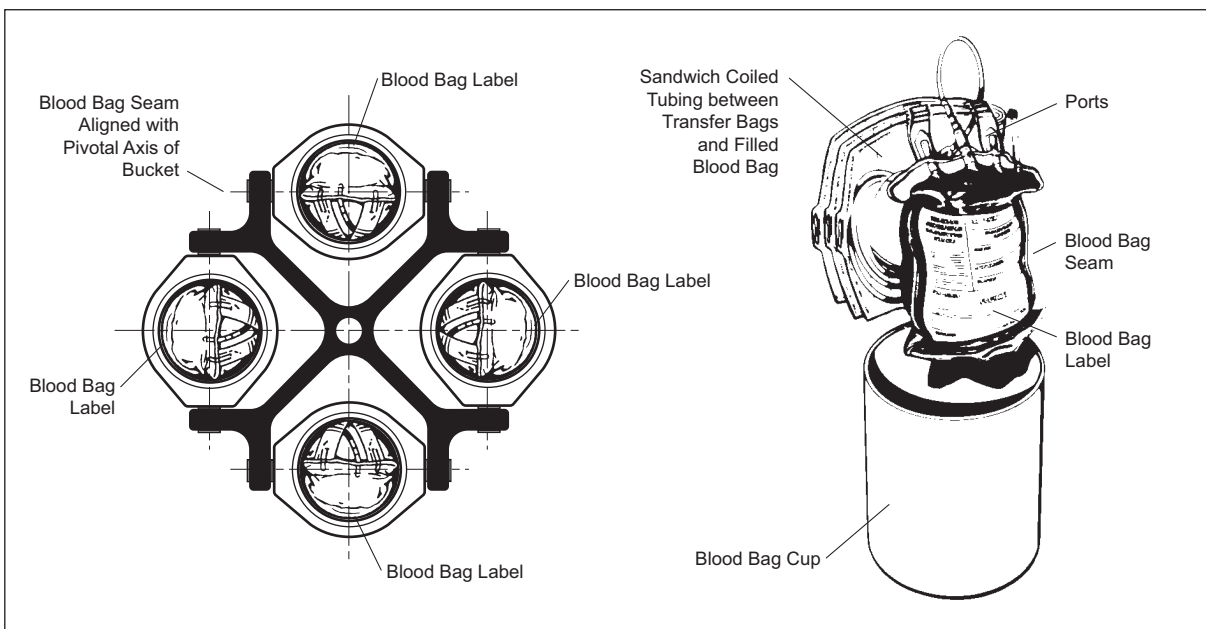

Figure 5-3. Typical Blood Bag Loading Procedure (JS-4.3 Rotor Shown)

- Place loaded cups into rotor buckets. If only two filled cups are run, place them in opposing buckets. The remaining buckets should contain similar “blank” loads to prevent imbalance (either empty modular disk adapters or water-filled blood bags in cups).

**CAUTION**

If bucket covers or rotor lids are not used, make sure the superstructure of the blood bag protruding from the cup does not inhibit the bucket from reaching its horizontal position. If it does, remove the cup from the rotor and reposition the blood bag so that it seats further into the cup. Allowing the blood bags to contact the rotor yoke during centrifugation can cause the bucket to come off the pivot pins and can seriously damage both the rotor and the centrifuge.

LOADING BUCKETS INTO THE ROTOR

NOTE

JS-24 series rotors must have buckets attached before the rotor is put into the centrifuge.

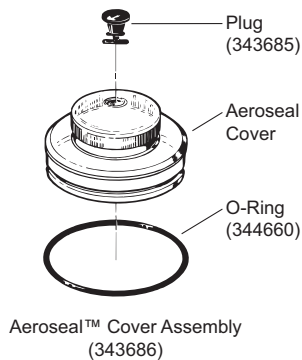

- If bucket covers or rotor lids are used to help contain spills and glass particles that could result from tube breakage, make sure cover O-rings are in good condition and lightly coated with silicone vacuum grease. Before use, inspect Aeroseal cover sealing surfaces, especially the O-ring groove. It must be smooth and free of scratches. Also ensure that the top 2.54 cm (1 in.) of the bucket is clean and smooth; buckets with scratches or gouges in this surface will not seal properly. Inspect the O-ring and plug for nicks, abrasions, and other damage. Replace damaged components.
- Load the filled buckets (and/or carriers) onto the rotor yoke pivot pins, following the instructions in the rotor manual. Make sure that the buckets are properly seated by gently swinging them on the pivot pins.

 **NOTE**

All positions on the rotor yoke must contain either a bucket or a microtiter plate carrier during a run.

Consult the applicable centrifuge instruction manual for operating instructions.

USING MICROTITER PLATE CARRIERS

Anodized aluminum microtiter plate carriers can be installed on the pivot pins in place of the buckets normally used with some swinging bucket rotors. Each carrier allows centrifugation of up to three 96-well microtiter plates. (For complete information about the carriers, see publication GS6-TB-011, which accompanies the Micro Plus carriers, or publication J6-TB-009, which accompanies the J6 series carriers.)

Microplates will break if *g*-forces are too high. Rotor speed must be reduced when microplate carriers are used. If microplate carriers and buckets are centrifuged in the same run, run speed must be reduced to the speed allowable for the microplates. Refer to the applicable rotor manual for allowable run speeds.

If only two carriers are run, they must be installed opposite each other in the rotor, and the remaining positions on the yoke must be filled with either buckets or other carriers (they need not be loaded) to prevent rotor imbalance. (See SYMMETRIC AND BALANCED LOADING, above.)

Micro Plus Carriers

1. To prevent microtiter plate breakage during centrifugation, place the flexible plastic pad, ridged side up, into the flat, indented area of the blue base (see Figure 5-4).
2. Place the plate(s) on top of the pad, being careful not to spill the contents.
3. Slide the base, pad, and plate assembly into the carrier until the base clicks into place.

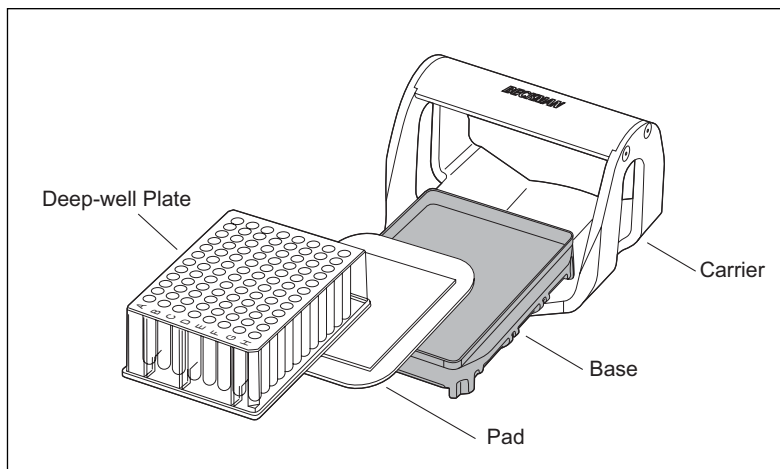
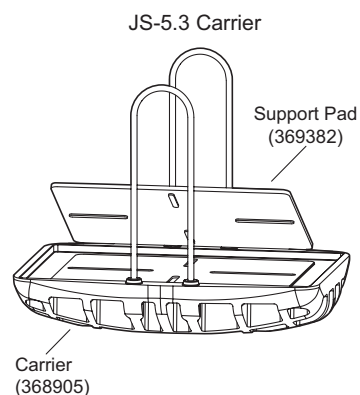
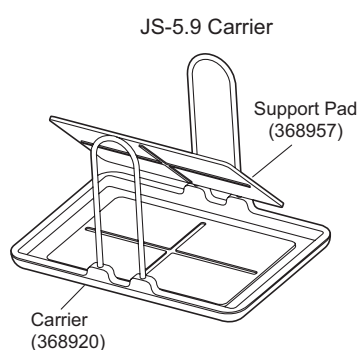

Figure 5-4. The Micro Plus Microtiter Plate Carrier, Base, Pad, and Deep-Well Microtiter Plate

JS-5.9 and JS-5.3 Plate Carriers



High-impact thermoplastic carriers are used in the JS-5.9 and JS-5.3 rotor buckets to provide support to labware during centrifugation and facilitate loading and unloading buckets. Each rotor bucket can carry a 96-well kit for high-throughput processing (such as a DNA or RNA kit), or standard microplates used in the serial dilution of small liquid volumes—up to five (JS-5.9) or six (JS-5.3) stacked 96-well polypropylene plates, two (stacked) deep-well plates, or one square-well plate per bucket.

NOTE

When using stacked polypropylene plates, place a support pad beneath the bottom plate to prevent breakage during centrifugation. Use the support pad beneath all polystyrene plates.

1. If using polystyrene or stacked polypropylene plates, place a support pad in the carrier with the ridged-cross side down.
2. Place the filled labware in the carrier. If using more than one microplate per carrier, place a cap strip between the plates to prevent breakage during centrifugation.
3. After centrifugation, grasp the carrier by the wire handles and lift it straight up out of the bucket to unload it.

J6 Carriers

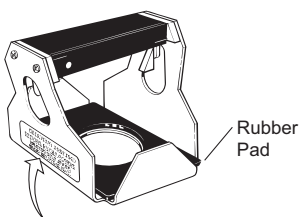

BECKMAN Matched-Weight Microplate Carrier
Run matched carriers 180° opposed on rotor
Weight stamped on carrier frame
Maximum Number Of Plates: 3
Use with only JS-5.2 and JS-4.0 rotors

Carriers used with the JS-5.2 and JS-4.0 rotors are NOT interchangeable with those used with the JS-4.2, JS-4.2A, JS-4.2SM, JS-3.0, and JS-2.9 rotors. If you have more than one type of carrier, check the label on the side of the carrier to make sure that you are using the right one for your rotor. Table 5-2 lists carriers used with J6 rotors.

1. To prevent microtiter plate breakage during centrifugation, place the rubber pad that comes with each carrier on the bottom of the carrier.
2. Place the plate(s) on top of the pad, being careful not to spill the contents.

Table 5-2. Microplate Carriers Used with J6 Series Rotors

| Rotor Type | Number Carriers | Rotor Load | Maximum Run Speed | Carrier Set Part Number |
|--|-----------------|--------------------------|-------------------|-------------------------|
| JS-5.2 or JS-4.0 | 4 | 12 single | 2600 rpm | 358680 (set of 2) |
| JS-4.2, JS-4.2A, JS-4.2SM, JS-3.0, or JS-2.9 | 6 | 18 single or 6 deep-well | 2500 rpm | 358682 (set of 2) |

OPERATION

Refer to the centrifuge instruction manual for detailed operating information. For low-temperature runs, precool the rotor in the centrifuge or in a refrigerator before use—especially before short runs—to ensure that the rotor reaches the set temperature. (To ensure that the rotor reaches the required temperature during centrifugation, some temperature compensation may be required because of the mass of these rotors. Refer to Appendix B or to the rotor manual for tables listing temperature compensation units for various rotors.)

ROTOR

If you are using a microprocessor-controlled J2 or J6 series centrifuge, enter the rotor code (if the JS-5.2 rotor is used for example, enter code **5.2**).

SAMPLE RECOVERY



CAUTION

If disassembly reveals evidence of leakage, you should assume that some fluid escaped the container or rotor. Use appropriate decontamination procedures on the centrifuge, rotor, and accessories.

1. Remove the rotor lid (if applicable). Remove the buckets or carriers from the rotor.
2. Remove labware from the buckets or carriers.



NOTE

Except for the JS-24.38 and JS-24.15 rotors, you can leave the rotor body or yoke in the centrifuge between runs unless spillage has occurred—in which case you should remove the buckets or carriers and yoke and clean the centrifuge and rotor components immediately, according to the instructions in the centrifuge and rotor instruction manuals. If the rotor is left in the centrifuge between runs, tighten the tie-down device before each run. The JS-24.38 and JS-24.15 rotors must be removed from the centrifuge to install or remove buckets.

Removing JS-24 Series Rotors

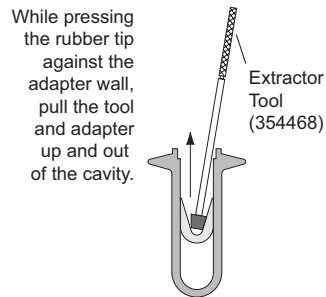

1. Remove the rotor from the centrifuge by lifting it straight up and off the drive hub.
2. Set the rotor on the rotor stand and carefully remove the buckets.
3. Remove the bucket caps and use the appropriate removal tool (listed in the rotor manual) to remove the spacers and tubes. If floating spacers were used, remove them with the threaded end of the floating spacer removal tool (338765).

NOTE

If the conical-shaped adapters that support *k*onical tubes are difficult to remove after centrifugation, an extractor tool (354468) is available to facilitate removal.

See Section 7 for instructions on the care of rotors, tubes or bottles, and accessories after a run.

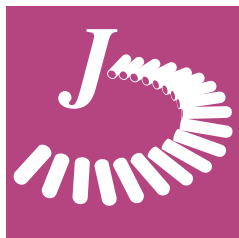

Using Vertical Tube and Rack-Type Rotors

This section contains instructions for using vertical tube or rack-type rotors in J series centrifuges. In addition to these instructions, observe procedures and precautions provided in the applicable rotor and centrifuge manuals.

Refer to Section 2 for tube selection information, and Section 3 for recommended filling and sealing requirements for each tube type and for sample recovery procedures. Refer to Section 7 for information on the care of rotors and accessories.

DESCRIPTION

Refer to Table 6-1 for general operating specifications for vertical tube and rack-type rotors.

VERTICAL TUBE ROTORS

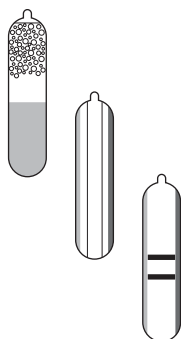

Vertical tube rotors (see Figure 6-1) hold tubes parallel to the axis of rotation; therefore, bands separate across the diameter of the tube rather than down the length of the tube (see Figure 1-3). Vertical tube rotors are useful for separating and banding subcellular particles. These rotors have plugs that are screwed into the rotor cavities over sealed Quick-Seal tubes. The plugs (with spacers, when required) restrain the tubes in the cavities and provide support against the hydrostatic force generated by centrifugation. Refer to Section 3 for information about filling and sealing Quick-Seal tubes for use in vertical tube rotors.

Table 6-1. General Specifications for Beckman Coulter J Series Vertical Tube and Rack-Type Rotors

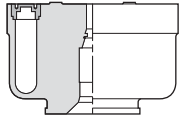
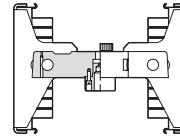
| Rotor Profile and Name | Max Speed*/ RCF/ k Factor | Critical Speed Range† (rpm) | Radial Distances (mm) | | | Number of Tubes × Nominal Capacity of Largest Tube | Nominal Rotor Capacity |
|---|---|-----------------------------|-----------------------|----------|-----------|--|------------------------|
| | | | r_{max} | r_{av} | r_{min} | | |
|  JV-20 (0° Angle) | 20 000 rpm $41\ 619 \times g$ 206 | 600 to 800 | 93 | 80 | 67 | 8 × 39 mL | 312 mL |
|  JR-3.2 (90° Angle at Speed) | 3200 rpm $2280 \times g$ 25 606 | 600 to 800 | 199 | 80 | 67 | 320 × 1 mL | 320 mL |

*Maximum speeds are based on a solution density of 1.7 g/mL for the JV-20 rotor and 1.2 g/mL for the JR-3.2 rotor.

†Critical speed range is the range of speeds over which the rotor shifts so as to rotate about its center of mass. Passing through or running at the critical speed range is characterized by some vibration.

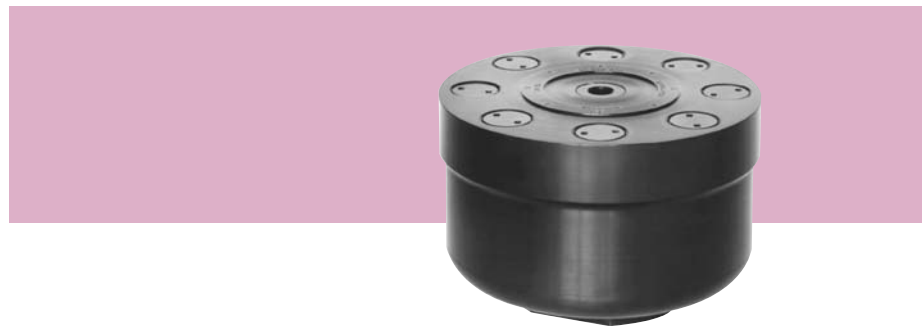
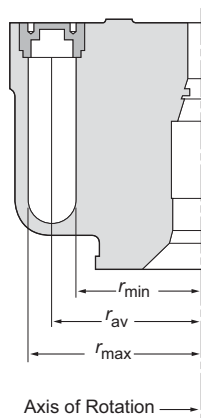

Figure 6-1. Vertical Tube Rotor

RACK-TYPE ROTORS

The rack-type rotor (see Figure 6-2) holds a wide range of gamma-counter tubes in tube racks. Racks are loaded into removable trays, which are then loaded into carriers at a resting angle. During centrifugation, the carriers swing out to a completely horizontal position to provide uniform pelleting of samples. The nearly vertical position of the racks during centrifugation permits processing of up to 320 mL in one run.

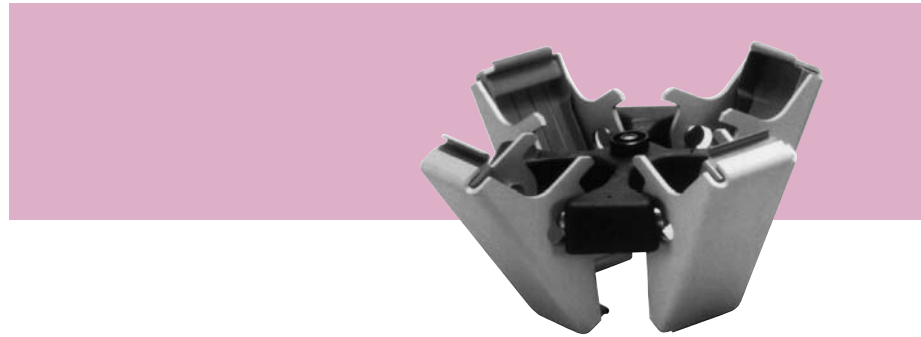
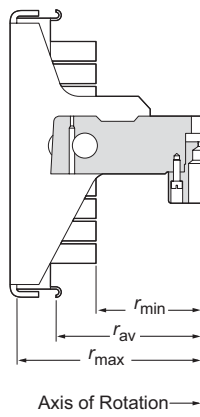

Figure 6-2. Rack-Type Rotor

NOTE

Although rotor components and accessories made by other manufacturers may fit in the Beckman Coulter rotor you are using, their safety in the rotor cannot be ascertained by Beckman Coulter. Use of other manufacturers' components or accessories in the Beckman Coulter rotor may void the rotor warranty, and should be prohibited by your laboratory safety officer. Only the components and accessories listed in the applicable rotor manual should be used.

USING A VERTICAL TUBE ROTOR

TUBES AND BOTTLES

Only Quick-Seal tubes, listed in the rotor manual, may be centrifuged in a vertical tube rotor. Refer to Section 3 for filling and sealing requirements of Quick-Seal tubes. Observe the maximum rotor speeds and fill volumes listed in the rotor manual.

ROTOR PREPARATION AND LOADING

For runs at other than room temperature, refrigerate or warm the rotor beforehand for fast equilibration.

Prerun Safety Checks



Read all safety information in the rotor manual before using the rotor.

1. Make sure that the rotor and plugs are clean and show no signs of corrosion or cracking.
2. Check the chemical compatibilities of all materials used. (Refer to Appendix A.)
3. Verify that the tubes, spacers, and floating spacers being used are in good condition and are listed in the rotor manual.

Rotor Preparation

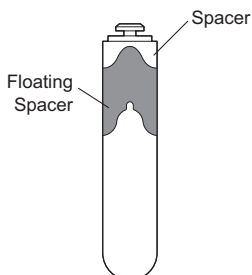
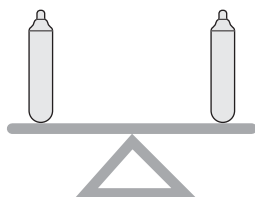

1. Be sure that the plug threads are lightly but evenly lubricated with Spinkote lubricant (306812).
2. Lubricate the rotor drive hole with silicone vacuum grease (335148).
3. Load the filled and sealed tubes symmetrically into the rotor. Opposing tubes must be filled to the same level with liquid of the same density. Refer to ROTOR BALANCE in Section 1.
4. Insert spacers and floating spacers, as listed in the rotor manual, to completely fill rotor cavities in use.
5. With the rotor in the rotor vise (332688), insert plugs over filled cavities *only*; do not insert plugs in empty cavities. Tighten the plugs using the plug wrench provided (340632).

OPERATION

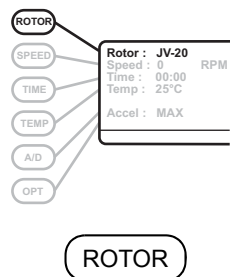

Refer to the centrifuge instruction manual for detailed operating information. For low-temperature runs, precool the rotor in the centrifuge or in a refrigerator before use—especially before short runs—to ensure that the rotor reaches the set temperature. (To ensure that the rotor reaches the required temperature during centrifugation, some temperature compensation may be required because of the mass of these rotors. Refer to Appendix B or to the rotor manual for tables listing temperature compensation units for various rotors.)

- If you are using an Avanti J series centrifuge, select the rotor number.
- If you are using a microprocessor-controlled J2 or J6 series centrifuge, enter the rotor code (enter code **20** for the JV-20 rotor).

INSTALLING THE ROTOR



CAUTION

The centrifuge drive spindle can be bent or broken if the rotor is forced sideways or dropped onto it. Install the rotor by centering it over the spindle and carefully lowering it straight down.

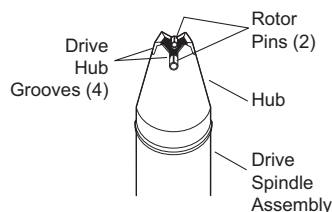

Older Model Centrifuges

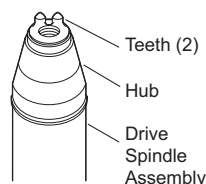

Newer Model Centrifuges

1. Carefully lower the rotor straight down onto the drive spindle.
2. Rotate the rotor by hand until the drive pins seat on the drive spindle hub.
 - In *older model centrifuges*—be sure the pins in the rotor drive hole are located in the grooves of the drive spindle hub.
 - In *newer model centrifuges*—be sure the pins in the rotor drive hole are not sitting on top of the teeth on the drive spindle hub.



CAUTION

The pins located in the rotor hub must be seated correctly on the centrifuge drive spindle. Running a rotor that is not seated properly may result in rotor failure.

3. Secure the rotor to the drive spindle hub with the rotor tie-down assembly.

REMOVAL AND SAMPLE RECOVERY



CAUTION

If disassembly reveals evidence of leakage, you should assume that some fluid escaped the container or rotor. Apply appropriate decontamination procedures to the centrifuge and accessories.

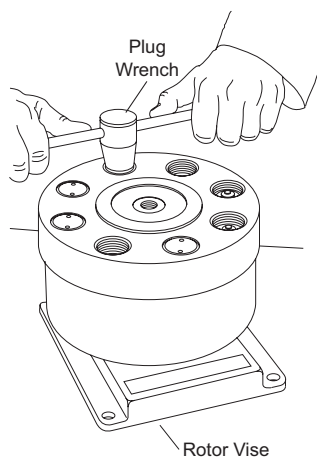

1. Remove the rotor tie-down assembly.
2. Lift the rotor straight up and off the drive spindle. If the rotor sticks to the drive spindle, a rotor removal tool may be used.



NOTE

Lubrication of the centrifuge drive spindle hub with Spinkote should prevent the rotor from sticking on all centrifuges except Avanti J series. Avanti J series centrifuges have Delrin rings on the spindle hubs to prevent sticking and do not require lubrication.

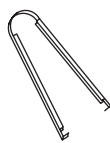

Tube Removal Tool
(361668)

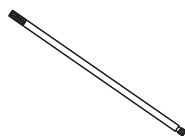

Floating Spacer
Removal Tool
(338765)

3. Place the rotor in the rotor vise and use the plug wrench to remove the rotor plugs.
4. Remove spacers with the floating spacer removal tool (338765) and tubes with the tube removal tool (361668).
5. Refer to Section 3 for sample recovery methods.

USING A RACK-TYPE ROTOR

TRAYS AND TUBES

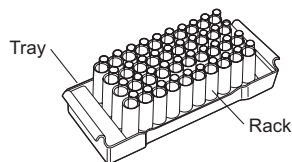

Two kinds of trays are available for use in the rack-type rotor to accommodate a variety of racks and tube sizes. The trays can be identified by color, as listed in the rotor manual. Some racks require the use of adapters, spacers, or frames to ensure a proper fit in the tray. Refer to the rotor manual to select compatible labware.

NOTE

Tubes should be no longer than 105 mm for proper clearance.

ROTOR PREPARATION AND LOADING

For runs at other than room temperature, refrigerate or warm the rotor beforehand for fast equilibration.

Prerun Safety Checks



Read all safety information in the rotor manual before using the rotor.

1. Make sure that the rotor yoke and carriers are clean and show no signs of corrosion or cracking.
2. Check the chemical compatibilities of all materials used. (Refer to Appendix A.)
3. Verify that the tube racks, trays, adapters, and spacers being used are in good condition and are listed in the rotor manual.

Rotor Preparation

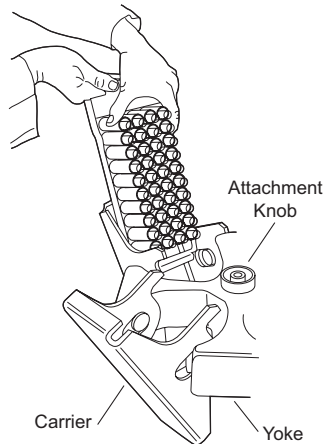

1. Lubricate the rotor drive hole with silicone vacuum grease (335148).
2. Load racks into either two or four trays, then load tubes into the racks. Do not over-fill tubes; leave enough space to avoid spills during carrier loading.

NOTE

Fill all tubes to the same level with liquid of the same density. Racks and tubes must be horizontally and vertically symmetrical during centrifugation.

3. Rest the end of the loaded tray on the carrier base. Slide the tray down so that it passes under the hinge pins. When it reaches the lower end of the carrier, seat the tray bottom completely into the carrier.

OPERATION

Refer to the centrifuge instruction manual for detailed operating information. For low-temperature runs, precool the rotor in the centrifuge or in a refrigerator before use—especially before short runs—to ensure that the rotor reaches the set temperature. (To ensure that the rotor reaches the required temperature during centrifugation, some temperature compensation may be required because of the mass of these rotors. Refer to Appendix B or to the rotor manual for tables listing temperature compensation units for various rotors.)

ROTOR

If you are using a microprocessor-controlled J6 series centrifuge, enter the rotor code (enter code **3.2** for the JR-3.2 rotor).

NOTE

These rotors are not used in Avanti J series centrifuges.

INSTALLING THE ROTOR



CAUTION

The centrifuge drive spindle can be bent or broken if the rotor is forced sideways or dropped onto it. Install the rotor by centering it over the spindle and carefully lowering it straight down.

1. Lift the rotor by the yoke and carefully lower it straight down onto the drive spindle.

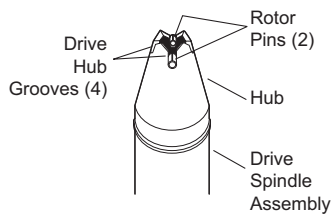

Older Model Centrifuges

2. Rotate the rotor by hand until the drive pins seat on the drive spindle hub.

- In *older model centrifuges*—be sure the pins in the rotor drive hole are located in the grooves of the drive spindle hub.

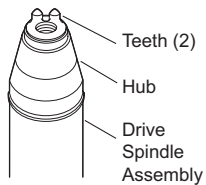

Newer Model Centrifuges

- In *newer model centrifuges*—be sure the pins in the rotor drive hole are not sitting on top of the teeth on the drive spindle hub.



CAUTION

The pins located in the rotor hub must be seated correctly on the centrifuge drive spindle. Running a rotor that is not seated properly may result in rotor failure.

3. Turn the tie-down knob to the right (clockwise) until the rotor is secure.

REMOVAL AND SAMPLE RECOVERY



CAUTION

If disassembly reveals evidence of leakage, you should assume that some fluid escaped the container or rotor. Apply appropriate decontamination procedures to the centrifuge, rotor, and accessories.

1. Turn the tie-down knob to the left (counterclockwise) to release the rotor from the drive spindle.
2. Lift the rotor straight up and off the drive spindle. If the rotor sticks to the drive spindle, a rotor removal tool may be used.



NOTE

Lubrication of the centrifuge drive spindle hub with Spinkote should prevent the rotor from sticking.

3. To remove a tray from a carrier, lift the end of the tray just enough to clear the carrier. Slide the tray up so that it passes under the hinge pins.

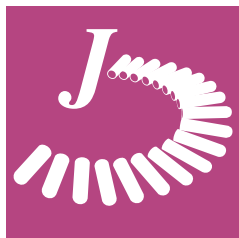

Care and Maintenance

This section provides information on the care of rotors and accessories. Included is a list of some common operating problems with suggestions for their solutions. Rotors and accessories should be kept in optimal condition, thus minimizing the chances of rotor or labware failure. In addition to these instructions, observe procedures and precautions provided in individual rotor manuals. Appendix A of this manual provides the chemical resistances of rotor and accessory materials to various acids, bases, salts, and solvents.

ROTOR CARE

Rotor care involves not only careful operating procedures but also careful attention to:

- Regular cleaning, decontamination, and/or sterilization as required,
- Frequent inspection,
- Corrosion prevention, and
- Regular and proper lubrication.

Do not use sharp tools on a rotor, as the surface can get scratched. Corrosion begins in scratches and may open fissures in the rotor with continued use. The corrosion process accelerates with speed-induced stresses. The potential for damage from corrosion is greatest in aluminum rotors and components.

CLEANING

Wash rotors and rotor components immediately if salts or other corrosive materials are used or if spillage has occurred. DO NOT allow corrosive materials to dry on the rotor.



NOTE

Do not wash rotor components or accessories in a dishwasher. Do not soak in detergent solution for long periods, such as overnight.

With normal usage, wash rotors frequently to prevent corrosion that can begin in scratches. Remove buckets from yokes before cleaning swinging bucket rotors.



CAUTION

Do not immerse or spray a swinging bucket rotor yoke (or body) with water because liquid can become trapped in the hinge pin area and lead to corrosion.

1. Use plastic or wooden tools to remove O-rings or gaskets for cleaning—*do not use metal tools* that could scratch anodized surfaces. Use a mild detergent such as Beckman Solution 555™ (339555), diluted 10 to 1 with water, and a soft brush to wash rotors and rotor components and accessories. (Most laboratory detergents are too harsh for aluminum rotors and components.) The Rotor Cleaning Kit (339558) contains two quarts of Solution 555 and brushes that will not scratch rotor surfaces.
2. Rinse thoroughly with water.
3. Air-dry the body or buckets upside down. *Do not use acetone to dry rotors.*

Wipe clean the O-rings or gaskets regularly (lubricate after cleaning). Replace them about twice a year or as required.

Frequently clean all surfaces that contact O-rings. Regularly clean the threads of the rotor (lid, handle, buckets, cavities, and so on.) with a nonmetal brush and a small amount of concentrated detergent, then rinse, and dry thoroughly. Lubricate the threads as directed under LUBRICATION, below.

Approximately once a week (or every 250 runs), clean the pins and bucket pin sockets of swinging bucket rotors to prevent buildup of residues. After cleaning, lubricate pin sockets as described under LUBRICATION, below.

**CAUTION**

Do not use acetone, MEK (methylethylketone), chloroform, cyclohexane, or organic solvents on carbon-fiber cannisters at any time. These substances will damage the epoxy resin surface material.

DECONTAMINATION

Rotors contaminated with radioactive or pathogenic materials must be decontaminated, following appropriate laboratory safety guidelines and/or other regulations.

NOTE

Strong bases and/or high-pH solutions can damage aluminum rotors and components.



- If a rotor (and/or accessories) becomes contaminated with radioactive material, it should be decontaminated using a solution that will not damage the anodized surfaces. Beckman Coulter has tested a number of solutions and found two that do not harm anodized aluminum: RadCon Surface Spray or IsoClean Solution (for soaking),¹ and Radiacwash.²

NOTE

IsoClean can cause fading of colored anodized surfaces. Use it only when necessary, and do not soak rotor components longer than the minimum time specified in the IsoClean usage instructions. Then remove it promptly from surfaces.

¹ In U.S., contact Nuclear Associates (New York); in Eastern Europe and Commonwealth States, contact Victoreen GmbH (Munich); in South Pacific, contact Gammasonics Pty. Ltd. (Australia); in Japan, contact Toyo Medic Co. Ltd. (Tokyo).

² In U.S., contact Biodex Medical Systems (Shirley, New York); internationally, contact the U.S. office to find the dealer closest to you.

While Beckman Coulter has tested these methods and found that they do not damage components, no guarantee of decontamination is expressed or implied. Consult your laboratory safety officer regarding the proper decontamination methods to use.



- If the rotor or other components are contaminated with toxic or pathogenic materials, follow appropriate decontamination procedures as outlined by appropriate laboratory safety guidelines and/or other regulations. Consult Appendix A to select an agent that will not damage the rotor.

STERILIZATION AND DISINFECTION

When sterilization or disinfection is a concern, consult your laboratory safety officer regarding proper methods to use. While Beckman Coulter has tested the following methods and found that they do not damage the rotor or components, no guarantee of sterility or disinfection is expressed or implied.

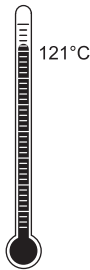

- Rotors and most rotor components (except those made of Noryl) can be autoclaved at 121°C for up to an hour. Remove the lid and place the rotor (and/or buckets) in the autoclave upside-down. (O-rings and gaskets can be left in place on the rotor.)
- Ethanol (70%)³ may be used on all rotor components, including those made of plastic. Bleach (sodium hypochlorite) may be used, but may cause discoloration of anodized surfaces. Use the minimum immersion time for each solution, per laboratory standards.

INSPECTION

Frequent and thorough inspection is crucial to maintaining a rotor in good operating condition.

- Periodically (at least monthly, depending on use) inspect the rotor, especially inside cavities and buckets, for rough spots, cracks, pitting, white powder deposits on aluminum rotors (frequently aluminum oxide), or heavy discoloration. If any of these signs are evident, do not run the rotor. Contact your Beckman Coulter representative for information about the Field Rotor Inspection Program and the Rotor Repair Program.

³ Flammability hazard. Do not use in or near operating centrifuges.

- Regularly check the condition of O-rings or gaskets and replace any that are worn or damaged.
- Regularly check that all sealing surfaces are smooth and undamaged to ensure proper sealing.
- Before each use, inspect Aero seal cover sealing surfaces, especially the O-ring groove. It must be smooth and free of scratches. Also ensure that the top 2.54 cm (1 in.) of the bucket is clean and smooth; buckets with scratches or gouges in this surface will not seal properly. Inspect the O-ring and plug for nicks, abrasions, and other damage. Replace damaged components with Beckman Coulter parts only; *do not use a substitute for the O-ring—it has been specifically selected for this application.*

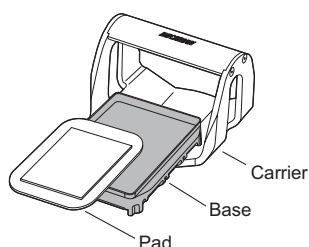
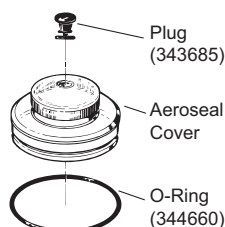

- Regularly check the condition of the Micro Plus carrier base and pad and do not use them if there are signs of damage. Retire the base from use after 1 year.

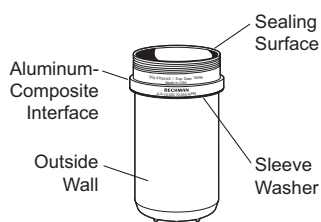

- Before each use, inspect carbon-fiber cannisters for cracks where carbon-fiber threads are visible. If any cracking or other damage is visible on the outside wall or near the aluminum-composite interface area, *do not use the cannister.* Contact your Beckman Coulter representative. Retire the cannister on the expiration date.

LUBRICATION

Regular and thorough lubrication can extend the useful life of rotor components.

O-Rings

Many rotors use O-rings or gaskets as seals to maintain atmospheric pressure in the rotor during a run. These O-rings and the rotor surfaces they bear against must be kept clean and evenly lubricated.

After removing and cleaning rotor or bucket O-rings or gaskets, lightly but uniformly coat them with silicone vacuum grease and reposition them in the rotor.

NOTE

Do not apply lubricant with a cotton-tipped swab. These swabs can leave lint on the O-ring or gasket that can interfere with the seal.

Pivot Pins and Buckets

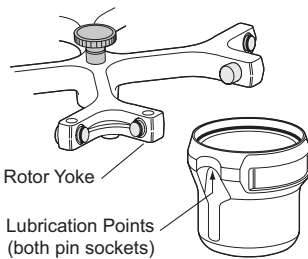

JS-4.2, JS-4.2A, JS-4.2SMA, JS-5.9, JS-5.3, JS-5.0, and JS-4.3 Rotors—Approximately once a week, and after cleaning and/or autoclaving, lubricate the pin sockets with a lubricant such as Paint On Graphite Lubricant (977212). Allow the lubricant to dry for at least 5 minutes before installing the rotor in a centrifuge.

JS-5.2, JS-4.2, JS-4.2A, JS-4.0, and JS-3.0 Rotors—Lubricate the O-ring and plug of Aeroseal bucket covers with silicone vacuum grease. Also, lightly grease the inside top 1.27 cm (0.5 in.) of the bucket.

FIELD ROTOR INSPECTION PROGRAM

The Field Rotor Inspection Program (FRIP) has two purposes:

- to prevent premature rotor failures by detecting conditions such as stress, corrosion, metal fatigue, damage, or wear in the anodized coatings; and
- to instruct laboratory personnel in the proper care of rotors.

Beckman Coulter has trained a group of experienced service engineers in the techniques of nondestructive evaluation. For more information about the program, contact your Beckman Coulter representative.

TUBE, BOTTLE, AND ACCESSORY CARE

Proper care of tubes and bottles involves observing temperature, fill volume, and run speed limitations as well as careful cleaning and sterilization procedures.

CLEANING

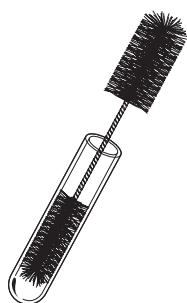

Do not wash tubes and bottles in a commercial dishwasher—detergents and temperatures are too harsh.

- Wash tubes, bottles, adapters, and blood bag cups by hand, using a mild detergent, such as Solution 555 (339555) diluted 10 to 1 with water, and a soft brush.
- Disassemble multitube adapters for cleaning. After washing with Solution 555 and a soft brush, rinse them with water, then dry and reassemble.
- Polycarbonate bottles and tubes are vulnerable to attack by alkaline solutions and detergents, so use a detergent with pH less than 9, such as Solution 555. Do not use a brush with exposed metal; scratches in polycarbonate will cause early failure.
- Alcohol and acetone react unsatisfactorily with many tube and accessory materials. If a solvent must be used to rinse, dry, or decontaminate these materials, consult Appendix A to select an appropriate solvent.
- Do not dry tubes, bottles, or accessories in an oven. Labware should be air-dried.
- Quick-Seal, Ultra-Clear, and thinwall polyallomer tubes are intended for one-time use and should be discarded after use.

DECONTAMINATION



Labware contaminated with radioactive or pathogenic solutions should be decontaminated or disposed of following appropriate safety guidelines and/or regulations. Consult Appendix A to select an agent that will not damage the tube or bottle material.

STERILIZATION AND DISINFECTION

Refer to Table 7-1 for sterilization methods recommended for each container type.

Table 7-1. Tube and Bottle Sterilization and Disinfection.

This information is provided as a guide to the use of sterilization and disinfection techniques for tube materials. Cold sterilization results shown are for short-duration (10-minute) soak periods; reactions may differ with extended contact.

Refer to Appendix A of this manual for information about specific solutions.

| Tube/Bottle Material | Autoclave ¹ (121°C) | UV Irradiation | Ethylene Oxide | Formaldehyde | Ethanol (70%) ² | Sodium Hypochlorite (10%) | Hydrogen Peroxide (10%) | Glutaraldehyde (2%) | Phenolic Derivatives |
|----------------------|--------------------------------|----------------|----------------|------------------|----------------------------|---------------------------|-------------------------|---------------------|----------------------|
| polyallomer | yes | no | yes | yes | yes | yes | yes | yes | no |
| Ultra-Clear | no | no | yes | yes ³ | yes | yes | yes | yes | no |
| polycarbonate | yes ⁴ | no | yes | yes ³ | no | yes ⁵ | yes | yes | no |
| polypropylene | yes | no | yes | yes | yes | yes ⁶ | yes ⁷ | yes | no |
| polyethylene | no | no | yes | yes | yes ⁸ | yes | yes | yes | yes |
| cellulose propionate | no | no | no | no | no | yes | yes | yes | no |
| stainless steel | yes | yes | yes | yes | yes ⁹ | no | yes | yes | no |

¹ To avoid deformation, autoclave tubes or bottles open-end down in a tube rack at 15 psig for no more than 20 minutes (allow to cool before removing from tube rack). DO NOT autoclave capped or sealed tubes or bottles.

² Flammable; do not use in or near operating centrifuges.

³ Do not use if there is methanol in the formula.

⁴ Tube life will be reduced by autoclaving.

⁵ Discoloration may occur.

⁶ Can be used if diluted.

⁷ Below 26°C only.

⁸ Below 21°C only.

⁹ Marginal.

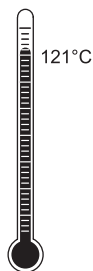

Most tubes and accessories, *except those made of Ultra-Clear, polyethylene, Noryl, or cellulose propionate*, can be autoclaved at 121°C for about 20 minutes. Note that autoclaving reduces the lifetime of polycarbonate tubes. Also, polyallomer tubes may be permanently deformed if they are autoclaved many times or if they are handled or compressed before they cool. Tubes should be placed open-end down or supported in a rack if autoclaved.

**CAUTION**

Do not autoclave tubes or bottles with caps on. Pressure in a sealed container can cause an explosion. Pressures within the autoclave can cause partially sealed containers to collapse when the autoclave vents.

JS-5.0 labware cups, cup covers, cup gaskets (369261 and 369257), and partitions can be autoclaved at 121°C for up to 20 minutes. Remove the plug and air-vent filter from each cup cover before autoclaving, and remove the gasket from the cup. To remove an air-vent filter, gently push it out from underneath the cover with a pencil or other non-metal tool that will not scratch the cover material. After autoclaving, insert a new air-vent filter into each cup cover. Thoroughly dry the gasket sealing surfaces before replacing the gasket.

**CAUTION**

Autoclaving will reduce the useful life of the labware cups, cup covers, cup gaskets, and partitions. After each autoclave cycle, examine these components for damage and DO NOT USE damaged components.

HarvestLine system liners can be gamma irradiated to a maximum dose of 40.0 kGy. Gamma irradiation causes the liners to become yellow, but does not affect their performance. *Do not steam or dry autoclave the liners or they will be damaged.* The liners are designed for single use only.

A cold sterilization method, such as immersion in 10% hydrogen peroxide for 30 minutes, may be used on Ultra-Clear tubes. Refer to Table 7-1 to select cold sterilization materials that will not damage tubes and accessories.

While Beckman Coulter has tested these methods and found that they do not damage the components, no guarantee of sterility or disinfection is expressed or implied. When sterilization or disinfection is a concern, consult your laboratory safety officer regarding proper methods to use.

NOTE

Multiwell plates can be purchased already sterilized.

INSPECTION

Inspect containers and accessories before use.

- Inspect tubes and bottles for cracks or any major deformities before using them.
- Do not use a tube that has become yellowed or brittle with age or excess exposure to ultraviolet light.
- Crazeing—the appearance of fine cracks on tubes and bottles—is the result of stress relaxation. If a crack approaches the outer wall of the tube or bottle, discard it.
- Discard any deformed or cracked adapters.

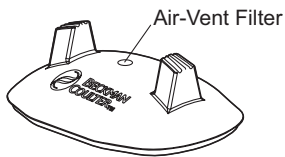

NOTE

Replace the air-vent filter in each JS-5.0 cup cover after every 250 cycles, or after every auto-clave cycle.

TUBE AND BOTTLE STORAGE

Tubes and bottles have an indefinite shelf life if properly stored. Store in a dark, cool, dry place away from ozone, chemical fumes, and ultraviolet light sources.

RETURNING A ROTOR OR ACCESSORY TO THE FACTORY

Before returning a rotor or accessory for any reason, prior permission (a Returned Goods Authorization form) must be obtained from Beckman Coulter, Inc. This RGA form may be obtained from your local sales office. It should contain the following information:

- serial number,
- history of use (approximate frequency of use),
- reason for the return,
- original purchase order number, billing number, and shipping number, if possible,
- name and phone number of the person to be notified upon receipt of the rotor or accessory at the factory, and
- name and phone number of the person to be notified about repair costs, etc.

To protect our personnel, it is the customer's responsibility to ensure that the parts are free from pathogens, chemical hazards, and/or radioactivity. Sterilization and decontamination **MUST** be done before returning the parts. Smaller items (such as tubes, bottles, and so on) should be enclosed in a sealed plastic bag.

*All parts must be accompanied by a note, plainly visible on the outside of the box or bag, stating that they are safe to handle and that they are not contaminated with pathogens, chemical hazards, or radioactivity. **Failure to attach this notification will result in return or disposal of the items without review of the reported problem.***

Use the address label printed on the RGA form when mailing the rotor and/or accessories to:

Beckman Coulter, Inc.
1050 Page Mill Road
Palo Alto, CA 94304

Attention: Returned Goods

Customers located outside the United States should contact their local Beckman Coulter office.

DIAGNOSTIC HINTS

Some of the more common operating problems experienced in centrifugation are listed below with suggestions for their solutions. Contact your Beckman Coulter Field Service representative if a problem cannot be corrected.

NOTE

Use only the labware listed in the applicable rotor manual.

| SYMPTOM | POSSIBLE CAUSE AND SUGGESTED ACTION |
|------------------|--|
| Rotors | |
| Severe vibration | <ul style="list-style-type: none"> • Rotor imbalance. To balance the rotor load, fill all opposing tubes to the same level with liquid of the same density. Weight of opposing tubes must be distributed equally. Place tubes in a fixed angle or vertical tube rotor symmetrically, as illustrated in Section 1 (Figure 1-7). Detailed information about balancing swinging bucket rotors is contained in Section 5. • Speed selected is within the rotor's critical speed range.⁴ Select a speed outside the critical speed range. (Refer to the applicable rotor manual for critical speed range.) • Rotor improperly tied-down. Make sure the rotor is properly secured to the drive spindle hub before centrifugation. If the rotor is left in the centrifuge between runs, tighten the tie-down device before each run. • Swinging bucket rotor—Mishooked bucket, loose bucket cover, wrong type of bucket, mixed bucket types, opposing buckets not filled to the same level with liquids of the same density. Check loading procedures (refer to Section 5). • Swinging bucket rotor—Pivot pin pockets not lubricated every 250 runs. Lubricate as described in LUBRICATION earlier in this section. |

⁴ Critical speed range is the range of speeds over which the rotor shifts so as to rotate about its center of mass. Passing through the critical speed range is characterized by some vibration.

| SYMPTOM | POSSIBLE CAUSE AND SUGGESTED ACTION |
|---|---|
| Rotors (continued) | |
| Rotor lid, cannister cover, or bucket cover is difficult to remove after centrifugation | <ul style="list-style-type: none"> • Vacuum built up inside the container during centrifugation. Lift the vent plug on bucket or cannister covers with vents to relieve the vacuum. • Threads contaminated with dirt, dried lubricant, or metal particles, or threads insufficiently lubricated cause rotor components to stick. Do not use excessive force to loosen components. Contact your Beckman Coulter representative. Routinely clean metal threads with concentrated Solution 555, then lubricate them with Spinkote. |
| Anodizing coming off where bucket or carrier contacts rotor pins on swinging bucket rotor | Not an operational problem (some buckets are not anodized inside the pin pockets to facilitate swinging). |
| Adapters | |
| Adapters stick in buckets after centrifugation | Apply a thin film of powder, such as talcum powder, to the tube adapter rubber bases after cleaning or as required to prevent sticking. |
| Tubes | |
| Tube leakage | |
| Tubes with cap assemblies | <ul style="list-style-type: none"> • Caps not properly secured. Caps must be properly seated on tubes and then fully tightened. • Cap components not dry before assembly. Thoroughly dry all components before assembling. |
| Tubes with snap-on caps | Tube too full; the meniscus must be kept lower to prevent leakage. |
| Uncapped tubes | Tube volume exceeds maximum uncapped volume. Refer to the rotor manual for tube volumes and speed reductions. |
| Quick-Seal tubes | Improperly sealed. After heat-sealing, squeeze the tube gently (if the tube contents may be disturbed) to test the seal for leaks. If the tube leaks, reseal it. |
| Tube cracking | |
| | <ul style="list-style-type: none"> • Tubes may crack or become brittle if they are used below their lower temperature limit. Before using tubes at other than stated temperature limits, evaluate them under centrifugation conditions. If sample is frozen in tubes, make sure that they are thawed to at least 2°C before centrifugation. • Tubes may become brittle with age and use. Dispose of brittle or cracked tubes. |

| SYMPTOM | POSSIBLE CAUSE AND SUGGESTED ACTION |
|---|---|
| Tubes (continued) | |
| <p>Tube collapse</p> | <ul style="list-style-type: none"> • Thinwall tube volume too low to provide tube wall support. Meniscus should be 2 to 3 mm below the tube top. Refer to the rotor manual for tube volumes. • Moisture between the tube and the cavity or bucket can cause the tube to float and collapse. Ensure that tubes and tube cavities or buckets are dry before inserting the tubes. • Reagent used that attacks the tube material. Refer to Appendix A for chemical compatibilities of tube material and chemicals. • Tubes run above their rated speed. Refer to the applicable rotor manual for maximum speeds. |
| Bottles | |
| <p>Bottle leakage (bottles with cap assemblies)</p> | <ul style="list-style-type: none"> • Moisture or lubrication on cap or sealing surface. Ensure that the O-ring, plug, and bottle lip are dry and free of lubrication before use. • O-ring or gasket damaged or defective. Replace the O-ring or gasket. • Cap not tightened sufficiently. Tighten cap securely. • Sealing surface of the bottle is not smooth. Replace bottle. • Threaded caps without inserts or O-rings—Tube too full; these are not as liquid-tight as cap assemblies; therefore, the meniscus must be kept lower to prevent leakage. |
| <p>Bottle leakage (uncapped bottles)</p> | <p>Bottle too full; the meniscus must be kept lower to prevent leakage. Refer to the rotor manual for fill volumes and speed reductions.</p> |
| <p>Bottle damage</p> | <ul style="list-style-type: none"> • Fill volume too low to provide tube wall support. Refer to the rotor manual for fill volumes and speed reduction. • Moisture between the bottle and the cavity or bucket can cause the bottle to float and collapse. Ensure that bottles and cavities or buckets are dry before inserting them. • Reagent used that attacks the bottle material. Refer to Appendix A for chemical compatibilities of bottle material and chemicals. • Bottles may crack or become brittle if they are used below their lower temperature limit. Before using bottles at other than stated temperature limits, evaluate them under centrifugation conditions. If sample is frozen in bottles, make sure that they are thawed to at least 2°C before centrifugation. • Bottles may become brittle with age and use. Dispose of brittle or cracked bottles. • Improper cleaning, decontamination, or sterilization procedures used. Refer to Table 7-1 for acceptable procedures and materials. |

Chemical Resistances for Beckman Coulter Centrifugation Products

To Close *Rotors and Tubes*
and Open the *Chemical Resistances Chart*

[Click Here](#)

Temperature Compensation Tables

This Appendix contains tables listing temperature compensation units for various rotors used in Beckman Coulter discontinued J2 and J6 series centrifuges.

TEMPERATURE COMPENSATION

To ensure that the rotor reaches the required temperature during centrifugation, some temperature compensation may be required because of the mass of these rotors. The following tables list temperature compensation units for various rotors.

Refer to Section 1 or the applicable rotor manual for procedures to set the temperature compensation for the model of J centrifuge being used.

NOTE

When using an Avanti J series centrifuge, enter the run temperature according to the instructions in your centrifuge instruction manual. No additional input is required.

Table B-1. Temperature Compensation Settings for the J2-HC Centrifuge.
Interpolate if intermediate values are required.

| Rotor | Speed (rpm) | Required Sample Temperature (°C, green bar) | | | | | | |
|------------|-------------|---|-------|-----|-----|------|------|------|
| | | -20°C | -10°C | 2°C | 5°C | 10°C | 20°C | 40°C |
| JA-25.50 | 18 000 | N | -8 | -6 | -6 | -6 | -6 | -5 |
| | 15 000 | -7 | -6 | -5 | -5 | -5 | -4 | -4 |
| | 10 000 | -5 | -3 | -2 | -3 | -4 | -3 | -2 |
| JA-25.15 | 18 000 | -8 | -7 | -5 | -6 | -6 | -5 | +5 |
| | 15 000 | -6 | -5 | -4 | -4 | -3 | -4 | +6 |
| | 10 000 | -3 | -2 | -1 | -2 | -1 | -1 | +9 |
| JA-21 | 18 000 | N | -8 | -8 | -7 | -6 | -5 | -3 |
| | 15 000 | -6 | -6 | -5 | -4 | -4 | -3 | N |
| | 10 000 | -4 | -2 | -1 | -1 | -1 | -1 | N |
| JA-20.1 | 18 000 | N | N | -7 | -7 | -7 | -6 | -4 |
| | 15 000 | -7 | -5 | -5 | -4 | -4 | -3 | -2 |
| | 10 000 | -4 | -2 | -1 | -1 | -1 | -1 | N |
| JA-20 | 18 000 | N | N | -6 | -6 | -5 | -4 | -3 |
| | 15 000 | -6 | -5 | -4 | -4 | -3 | -3 | -2 |
| | 10 000 | -4 | -4 | -3 | -2 | -2 | -2 | -2 |
| JA-18.1* | 16 000 | N | N | -8 | -5 | -4 | -3 | 0 |
| | 15 000 | N | N | -2 | -2 | -2 | -2 | 0 |
| | 10 000 | -4 | -3 | -3 | -3 | -3 | -2 | N |
| | 8 000 | -1 | -2 | -4 | -3 | -2 | -1 | N |
| JA-18 | 18 000 | N | N | N | N | N | -8 | -4 |
| | 17 000 | N | N | N | -10 | -9 | -8 | -3 |
| | 16 000 | N | N | -10 | -9 | -8 | -7 | -2 |
| | 12 000 | N | -6 | -6 | -5 | -4 | -3 | -1 |
| | 8 000 | -3 | -2 | -2 | -1 | -1 | 0 | N |
| | 5 000 | -1 | -1 | -1 | -1 | 0 | +1 | N |
| JA-17 | 17 000 | N | N | -6 | -6 | -6 | -5 | -3 |
| | 15 000 | N | -5 | -4 | -4 | -4 | -3 | -2 |
| | 12 000 | -4 | -4 | -3 | -3 | -3 | -2 | N |
| | 8 000 | -2 | -2 | -2 | -2 | -2 | -1 | N |
| JLA-16.250 | 14 000 | N | N | 7 | -7 | -7 | -5 | -4 |
| | 10 000 | N | -4 | -3 | -3 | -2 | -1 | N |
| | 5 000 | N | 0 | 0 | -3 | -3 | -3 | N |



Continued —

For proper temperature control the JA-18.1 fixed angle rotor must be derated in the J2-HC Centrifuge as follows: when the 25-degree-angle adapters are used, the maximum speed is 16 000 rpm; when the 45-degree-angle adapters are used, the maximum speed is 15 000 rpm.

† Above 30°C ambient temperature, this temperature may not be achieved at this speed.
N: indicates that the rotor cannot achieve the required temperature at this speed.

Table B-1. Temperature Compensation Settings for the J2-HC Centrifuge (continued)

| Rotor | Speed (rpm) | Required Sample Temperature (°C, green bar) | | | | | | |
|------------|-------------|---|-----------------|-----|-----|------|------|------|
| | | -20°C | -10°C | 2°C | 5°C | 10°C | 20°C | 40°C |
| JA-14 | 14 000 | N | N | -5 | -5 | -5 | -3 | -2 |
| | 12 000 | N | -3 | -3 | -3 | -3 | -2 | -1 |
| | 10 000 | -4 | -2 | -2 | -2 | -1 | -1 | N |
| | 5 000 | -1 | 0 | 0 | 0 | 0 | 0 | N |
| JA-12 | 12 000 | N | -3 | -2 | -2 | -2 | -2 | -1 |
| | 10 000 | -2 | -2 | -1 | -1 | -1 | -1 | -1 |
| | 5 000 | -1 | -1 | 0 | 0 | 0 | 0 | 0 |
| JA-10 | 10 000 | N | -3 | -2 | -1 | 0 | +1 | +2 |
| | 8 000 | -3 | -2 | 0 | 0 | 0 | +1 | +2 |
| | 5 000 | -2 | 0 | 0 | 0 | 0 | +1 | +2 |
| JLA-10.500 | 10 000 | N | -6 [†] | -3 | -3 | -3 | -1 | 0 |
| | 8 000 | -3 [†] | -3 | -3 | -2 | -2 | -1 | 0 |
| | 5 000 | -3 [†] | -2 | -2 | -1 | 0 | 0 | +2 |
| JS-13.1 | 13 000 | N | -6 | -9 | -9 | -9 | -6 | -3 |
| | 11 000 | N | -5 | -5 | -5 | -5 | -4 | -1 |
| | 8 000 | -5 | -3 | -2 | -2 | -1 | -1 | N |
| | 5 000 | -4 | -2 | -1 | -1 | -1 | 0 | N |
| JS-7.5 | 7 500 | 0 | +2 | +3 | +3 | +4 | +4 | +4 |
| | 5 000 | 0 | +1 | +2 | +2 | +2 | +3 | +3 |
| | 2 000 | 0 | 0 | 0 | +1 | +1 | +2 | N |
| JS-4.3 | 4 300 | 0 | 0 | 0 | 0 | 0 | 0 | +2 |
| | 3 000 | 0 | 0 | 0 | 0 | 0 | 0 | +2 |
| | 1 500 | 0 | 0 | 0 | 0 | 0 | 0 | N |
| JV-20 | 18 000 | N | N | -9 | -8 | -7 | -6 | -6 |
| | 15 000 | N | -7 | -5 | -5 | -5 | -3 | -4 |
| | 10 000 | -4 | -3 | -3 | -3 | -3 | -1 | 0 |

 **CAUTION**

For proper temperature control the JA-18.1 fixed angle rotor must be derated in the J2-HC Centrifuge as follows: when the 25-degree-angle adapters are used, the maximum speed is 16 000 rpm; when the 45-degree-angle adapters are used, the maximum speed is 15 000 rpm.

[†] Above 30°C ambient temperature, this temperature may not be achieved at this speed.

N: indicates that the rotor cannot achieve the required temperature at this speed.

Table B-2. Temperature Compensation Settings for the J2-21, J2-21B, J2-21C, and J2-HS Centrifuges.
Interpolate if intermediate values are required.

| Rotor | Speed (rpm) | Required Sample Temperature (°C, green bar) | | | | | | |
|------------|-------------|---|-------|-----|-----|------|------|------|
| | | -20°C | -10°C | 2°C | 5°C | 10°C | 20°C | 40°C |
| JA-25.50 | 20 000 | N | N | -7 | -5 | -6 | -5 | -9 |
| | 18 000 | N | -5 | -5 | -5 | -5 | -4 | -7 |
| | 15 000 | 0 | -2 | -3 | -3 | -2 | -2 | -6 |
| | 10 000 | 0 | 0 | -1 | 0 | -1 | 0 | -3 |
| JA-25.15 | 21 000 | N | N | -10 | -10 | -7 | -6 | -9 |
| | 18 000 | N | -8 | -8 | -7 | -4 | -5 | -5 |
| | 15 000 | -6 | -6 | -5 | -4 | -4 | -3 | -2 |
| | 10 000 | -3 | -2 | -1 | -1 | -1 | -1 | -2 |
| JA-21 | 21 000 | N | N | -10 | -10 | -10 | -8 | -6 |
| | 18 000 | N | -8 | -8 | -7 | -6 | -5 | -3 |
| | 15 000 | -6 | -6 | -5 | -4 | -4 | -3 | N |
| | 10 000 | -3 | -2 | -1 | -1 | -1 | 0 | N |
| JA-20.1 | 20 000 | N | N | -10 | -9 | -9 | -9 | -7 |
| | 18 000 | N | N | -7 | -7 | -7 | -6 | -4 |
| | 15 000 | -7 | -5 | -4 | -4 | -4 | -3 | N |
| | 10 000 | -2 | -1 | -1 | 0 | 0 | 0 | N |
| JA-20 | 20 000 | N | N | -9 | -8 | -7 | -7 | -6 |
| | 18 000 | N | N | -6 | -6 | -5 | -4 | -3 |
| | 15 000 | -5 | -4 | -4 | -4 | -3 | -2 | -1 |
| | 10 000 | -2 | -2 | -1 | 0 | 0 | 0 | 0 |
| JA-18.1 | 18 000 | N | N | N | N | -8 | -5 | 0 |
| | 17 000 | N | N | N | N | -6 | -5 | 0 |
| | 15 000 | N | N | -9 | -5 | -4 | -3 | 0 |
| | 10 000 | -7 | -7 | -3 | -3 | -2 | 0 | +2 |
| | 8 000 | -6 | -5 | -3 | -3 | -1 | 0 | +2 |
| JA-18 | 18 000 | N | N | N | N | N | -10 | -7 |
| | 17 000 | N | N | N | -10 | -9 | -8 | -6 |
| | 16 000 | N | N | -10 | -10 | -9 | -7 | -5 |
| | 12 000 | N | -6 | -6 | -6 | -5 | -4 | -3 |
| | 8 000 | -5 | -4 | -4 | -3 | -2 | -1 | 0 |
| | 5 000 | -4 | -3 | -2 | -2 | -1 | 0 | 0 |
| JA-17 | 17 000 | N | N | -7 | -7 | -7 | -4 | -2 |
| | 15 000 | N | -5 | -4 | -4 | -4 | -3 | -1 |
| | 12 000 | -4 | -4 | -3 | -3 | -3 | -1 | N |
| | 8 000 | -1 | -1 | 0 | 0 | 0 | 0 | N |
| JLA-16.250 | 14 000 | N | N | -7 | -5 | -4 | -3 | -3 |
| | 10 000 | N | -4 | -3 | -3 | -2 | -1 | N |
| | 5 000 | N | 0 | 0 | 0 | 0 | 0 | N |

* Above 30°C ambient temperature, this temperature may not be achieved at this speed.
N: indicates that the rotor cannot achieve the required temperature at this speed.

Continued —

Table B-2. Temperature Compensation Settings for the J2-21, J2-21B, J2-21C, and J2-HS Centrifuges (continued)

| Rotor | Speed (rpm) | Required Temperature (°C, green bar) | | | | | | |
|------------|-------------|--------------------------------------|-------|------|------|------|------|------|
| | | -20°C | -10°C | 2°C | 5°C | 10°C | 20°C | 40°C |
| JA-14 | 14 000 | N | N | -7 | -7 | -7 | -5 | -4 |
| | 12 000 | N | -6 | -5 | -5 | -4 | -3 | -2 |
| | 10 000 | -4 | -4 | -3 | -3 | -2 | -1 | N |
| | 5 000 | -1 | 0 | 0 | 0 | 0 | 0 | N |
| JA-12 | 12 000 | N | -6 | -6 | -7 | -7 | -6 | -9 |
| | 10 000 | -3 | -4 | -5 | -5 | -5 | -5 | -9 |
| | 5 000 | -1 | -3 | -3 | -4 | -4 | -5 | -9 |
| JA-10 | 10 000 | N | -3 | -2 | -1 | 0 | +1 | +2 |
| | 8 000 | -3 | -2 | -1 | -1 | 0 | +1 | +2 |
| | 5 000 | -2 | 0 | 0 | 0 | 0 | +1 | +2 |
| JLA-10.500 | 10 000 | N | -5* | -2 | -1 | +0 | +2 | +1 |
| | 8 000 | -1* | -1* | +0 | +2 | +2 | +3 | +1 |
| | 5 000 | -0* | -1 | +2 | +1 | +4 | +3 | +1 |
| JS-13.1 | 13 000 | N | -10 | -10 | -10 | -10 | -10 | -9 |
| | 11 000 | N | -8 | -8 | -8 | -7 | -6 | -5 |
| | 8 000 | -6 | -5 | -4 | -4 | -3 | -3 | N |
| | 5 000 | -4 | -3 | -1 | -1 | -1 | -1 | N |
| JS-7.5 | 7 500 | -4 | -3 | +1 | +1 | +1 | +2 | +3 |
| | 5 000 | -2 | 0 | +3 | +3 | +3 | +3 | +4 |
| | 2 000 | 0 | +2 | +4 | +4 | +4 | +4 | +5 |
| JV-20 | 20 000 | N | N | -max | -max | -max | - | -max |
| | 18 000 | N | N | -max | -max | -10 | max | -9 |
| | 15 000 | N | N | -7 | -7 | -6 | -10 | -4 |
| | 10 000 | N | N | -2 | -2 | -1 | -5 | 0 |

* Above 30°C ambient temperature, this temperature may not be achieved at this speed.
 N: indicates that the rotor cannot achieve the required temperature at this speed.

Table B-3. Temperature Compensation Settings for the J2-MI, J2-21M, J2-MC, and J2-21M/E Centrifuges. Interpolate if intermediate values are required.

| Rotor | Speed (rpm) | Required Sample Temperature (°C, green bar) | | | | | | |
|------------|-------------|---|-------|-----|-----|------|------|------|
| | | -20°C | -10°C | 2°C | 5°C | 10°C | 20°C | 40°C |
| JA-25.50 | 20 000 | N | N | -7 | -5 | -6 | -5 | -9 |
| | 18 000 | N | -5 | -5 | -5 | -5 | -4 | -7 |
| | 15 000 | 0 | -2 | -3 | -3 | -2 | -2 | -6 |
| | 10 000 | 0 | 0 | -1 | 0 | -1 | 0 | -3 |
| JA-25.15 | 21 000 | N | N | -8 | -8 | -7 | -6 | -9 |
| | 18 000 | N | -8 | -8 | -8 | -4 | -5 | -5 |
| | 15 000 | -6 | -6 | -5 | -4 | -4 | -3 | -2 |
| | 10 000 | -3 | -2 | -1 | -1 | -1 | -1 | -2 |
| JA-21 | 21 000 | N | N | -10 | -10 | -10 | -8 | -6 |
| | 18 000 | N | -8 | -8 | -7 | -6 | -5 | -3 |
| | 15 000 | -6 | -6 | -5 | -4 | -4 | -3 | N |
| | 10 000 | -3 | -2 | -1 | -1 | -1 | 0 | N |
| JA-20.1 | 20 000 | N | N | -10 | -9 | -9 | -9 | -7 |
| | 18 000 | N | N | -7 | -7 | -7 | -6 | -4 |
| | 15 000 | -7 | -5 | -4 | -4 | -4 | -3 | N |
| | 10 000 | -2 | -1 | -1 | 0 | 0 | 0 | N |
| JA-20 | 20 000 | N | N | N | 11 | 10 | 9 | -6 |
| | 18 000 | N | N | 8 | 7.5 | 7 | 6 | -3 |
| | 15 000 | -5 | -4 | 4 | 4 | 3 | 3 | -1 |
| | 10 000 | -2 | -2 | 2 | 1 | 1 | 0 | 0 |
| JA-18.1 | 18 000 | N | N | N | N | -8 | -5 | 0 |
| | 17 000 | N | N | N | N | -6 | -5 | 0 |
| | 15 000 | N | N | -9 | -5 | -4 | -3 | 0 |
| | 10 000 | -7 | -7 | -3 | -3 | -2 | 0 | +2 |
| | 8 000 | -6 | -5 | -3 | -3 | -1 | 0 | +2 |
| JA-18 | 18 000 | N | N | N | N | N | -10 | -7 |
| | 17 000 | N | N | N | -10 | -9 | -8 | -6 |
| | 16 000 | N | N | -10 | -10 | -9 | -7 | -5 |
| | 12 000 | N | -6 | -6 | -6 | -5 | -4 | -3 |
| | 8 000 | -5 | -4 | -4 | -3 | -2 | -1 | 0 |
| | 5 000 | -4 | -3 | -2 | -2 | -1 | 0 | 0 |
| JA-17 | 17 000 | N | N | -7 | -7 | -7 | -4 | -2 |
| | 15 000 | N | -5 | -4 | -4 | -4 | -3 | -1 |
| | 12 000 | -4 | -4 | -3 | -3 | -3 | -1 | N |
| | 8 000 | -1 | -1 | 0 | 0 | 0 | 0 | N |
| JLA-16.250 | 14 000 | N | N | -7 | -5 | -4 | -3 | -3 |
| | 10 000 | N | -4 | -3 | -3 | -2 | -1 | N |
| | 5 000 | N | 0 | 0 | 0 | 0 | 0 | N |
| JA-14 | 14 000 | N | N | -7 | -7 | -7 | -5 | -4 |
| | 12 000 | N | -6 | -5 | -5 | -4 | -3 | -2 |
| | 10 000 | -4 | -4 | -3 | -3 | -2 | -1 | N |
| | 5 000 | -1 | 0 | 0 | 0 | 0 | 0 | N |

* Above 30°C ambient temperature, this temperature may not be achieved at this speed.
 N: indicates that the rotor cannot achieve the required temperature at this speed.

Continued —

Table B-3. Temperature Compensation Settings for the J2-MI, J2-21M, J2-MC, and J2-21M/E Centrifuges (continued)

| Rotor | Speed (rpm) | Required Sample Temperature (°C, green bar) | | | | | | |
|------------|-------------|---|-------|-----|------|------|---------|------|
| | | -20°C | -10°C | 2°C | 5°C | 10°C | 20°C | 40°C |
| JA-12 | 12 000 | N | -6 | -6 | -7 | -7 | -6 | -9 |
| | 10 000 | -3 | -4 | -5 | -5 | -5 | -5 | -9 |
| | 5 000 | -1 | -3 | -3 | -4 | -4 | -5 | -9 |
| JA-10 | 10 000 | N | -3 | -2 | -1 | 0 | +1 | +2 |
| | 8 000 | -3 | -2 | -1 | -1 | 0 | +1 | +2 |
| | 5 000 | -2 | 0 | 0 | 0 | 0 | +1 | +2 |
| JLA-10.500 | 10 000 | N | -5* | -2 | -1 | 0 | +2 | +1 |
| | 8 000 | -1* | -1* | 0 | +2 | +2 | +3 | +1 |
| | 5 000 | -0* | -1 | +2 | +1 | +4 | +3 | +1 |
| JS-13.1 | 13 000 | N | -10 | -10 | -10 | -10 | -10 | -9 |
| | 11 000 | N | -8 | -8 | -8 | -7 | -6 | -5 |
| | 8 000 | -6 | -5 | -4 | -4 | -3 | -3 | N |
| | 5 000 | -4 | -3 | -1 | -1 | -1 | -1 | N |
| JS-7.5 | 7 500 | -4 | -3 | +1 | +1 | +1 | +2 | +3 |
| | 5 000 | -2 | 0 | +3 | +3 | +3 | +3 | +4 |
| | 2 000 | 0 | +2 | +4 | +4 | +4 | +4 | +5 |
| JV-20 | 20 000 | N | N | N | N | -max | - | -max |
| | 18 000 | N | N | N | -max | -10 | max | -9 |
| | 15 000 | N | N | -7 | -7 | -6 | -10 | -4 |
| | 10 000 | N | N | -2 | -2 | -1 | -5 0 | 0 |

* Above 30°C ambient temperature, this temperature may not be achieved at this speed.

N: indicates that the rotor cannot achieve the required temperature at this speed.

Table B-4. Temperature Compensation Settings for the J6 Centrifuges

| Rotor | Speed (rpm) | Required Sample Temperature (°C, green bar) | | | | | | |
|---|-----------------|---|-----|-----|------|------|------|------|
| | | 2°C | 4°C | 8°C | 10°C | 15°C | 20°C | 30°C |
| JS-5.2 | 5 200 | -3 | -1 | 4 | 6 | 10 | 17 | 28 |
| | 4 000 | -1 | 1 | 5 | 7 | 12 | 19 | 29 |
| | 3 000 | 0 | 2 | 7 | 9 | 14 | 20 | 30 |
| | 2 000 and below | 2 | 4 | 8 | 10 | 15 | 20 | 30 |
| JS-4,2, JS-4.2SM, JS-4.2A, JS-4.2SMA | 4 200 | -3 | 0 | 5 | 7 | 13 | 19 | 30 |
| | 3 000 | 0 | 2 | 7 | 9 | 14 | 20 | 30 |
| | 2 000 and below | 2 | 4 | 8 | 10 | 15 | 20 | 30 |
| All other rotors | all speeds | 2 | 4 | 8 | 10 | 15 | 20 | 30 |

Gradient Materials

This Appendix contains reference information on commonly used gradient materials. General instructions for filling and sealing tubes, including gradient preparation, are contained in Section 3.

Gradient material selection depends on a number of factors, including the type of separation to be performed. Sucrose is used for rate zonal and isopycnic separations, and cesium chloride is often used for isopycnic separations. The basic requirement is that the gradient permit the type of separation. Additional considerations in selecting a gradient material include the following.

- Its density range should be sufficient to permit separation of the particles of interest by the chosen density gradient technique, without overstressing the rotor.
- It should not affect the biological activity of the sample.
- It should be neither hyperosmotic or hypoosmotic when the sample is composed of sensitive organelles.
- It should not interfere with the assay technique.
- It should be removable from the purified product.
- It should not absorb in the ultraviolet or visible range.
- It should be inexpensive and readily available; more expensive materials should be recoverable for reuse.
- It should be sterilizable.
- It should not be corrosive to the rotor.
- It should not be flammable or toxic to the extent that its aerosols could be hazardous.

The following charts are provided as a reference for information on commonly used gradient materials.

Table C-1. Commonly Used Gradient Materials
with Their Solvents

| Materials | Solvent | Maximum Density at 20°C |
|-------------------|------------------|-------------------------|
| Sucrose (66%) | H ₂ O | 1.32 |
| Sucrose (65%) | D ₂ O | 1.37 |
| Silica sols | H ₂ O | 1.30 |
| Diodon | H ₂ O | 1.37 |
| Glycerol | H ₂ O | 1.26 |
| Cesium chloride | H ₂ O | 1.91 |
| | D ₂ O | 1.98 |
| Cesium formate | H ₂ O | 2.10 |
| Cesium acetate | H ₂ O | 2.00 |
| Rubidium chloride | H ₂ O | 1.49 |
| Rubidium formate | H ₂ O | 1.85 |
| Rubidium bromide | H ₂ O | 1.63 |
| Potassium acetate | H ₂ O | 1.41 |
| Potassium formate | H ₂ O | 1.57 |
| | D ₂ O | 1.63 |
| Sodium formate | H ₂ O | 1.32 |
| | D ₂ O | 1.40 |
| Lithium bromide | H ₂ O | 1.83 |
| Lithium chloride | D ₂ O | 1.33 |
| Albumin | H ₂ O | 1.35 |
| Sorbitol | H ₂ O | 1.39 |
| Ficoll | H ₂ O | 1.17 |
| Metrizamide | H ₂ O | 1.46 |

Table C-2. Density, Refractive Index, and Concentration Data—Cesium Chloride at 25°C, Molecular Weight = 168.37

| Density (g/cm ³)* | Refractive Index, η_D | % by Weight | mg/mL of Solution [†] | Molarity | Density (g/cm ³)* | Refractive Index, η_D | % by Weight | mg/mL of Solution [†] | Molarity |
|-------------------------------|----------------------------|-------------|--------------------------------|----------|-------------------------------|----------------------------|-------------|--------------------------------|----------|
| 1.0047 | 1.3333 | 1 | 10.0 | 0.056 | 1.336 | 1.3657 | 34 | 454.2 | 2.698 |
| 1.0125 | 1.3340 | 2 | 20.2 | 0.119 | 1.3496 | 1.3670 | 35 | 472.4 | 2.806 |
| 1.0204 | 1.3348 | 3 | 30.6 | 0.182 | 1.363 | 1.3683 | 36 | 490.7 | 2.914 |
| 1.0284 | 1.3356 | 4 | 41.1 | 0.244 | 1.377 | 1.3696 | 37 | 509.5 | 3.026 |
| 1.0365 | 1.3364 | 5 | 51.8 | 0.308 | 1.391 | 1.3709 | 38 | 528.6 | 3.140 |
| 1.0447 | 1.3372 | 6 | 62.8 | 0.373 | 1.406 | 1.3722 | 39 | 548.3 | 3.257 |
| 1.0531 | 1.3380 | 7 | 73.7 | 0.438 | 1.4196 | 1.3735 | 40 | 567.8 | 3.372 |
| 1.0615 | 1.3388 | 8 | 84.9 | 0.504 | 1.435 | 1.3750 | 41 | 588.4 | 3.495 |
| 1.0700 | 1.3397 | 9 | 96.3 | 0.572 | 1.450 | 1.3764 | 42 | 609.0 | 3.617 |
| 1.0788 | 1.3405 | 10 | 107.9 | 0.641 | 1.465 | 1.3778 | 43 | 630.0 | 3.742 |
| 1.0877 | 1.3414 | 11 | 119.6 | 0.710 | 1.481 | 1.3792 | 44 | 651.6 | 3.870 |
| 1.0967 | 1.3423 | 12 | 131.6 | 0.782 | 1.4969 | 1.3807 | 45 | 673.6 | 4.001 |
| 1.1059 | 1.3432 | 13 | 143.8 | 0.854 | 1.513 | 1.3822 | 46 | 696.0 | 4.134 |
| 1.1151 | 1.3441 | 14 | 156.1 | 0.927 | 1.529 | 1.3837 | 47 | 718.6 | 4.268 |
| 1.1245 | 1.3450 | 15 | 168.7 | 1.002 | 1.546 | 1.3852 | 48 | 742.1 | 4.408 |
| 1.1340 | 1.3459 | 16 | 181.4 | 1.077 | 1.564 | 1.3868 | 49 | 766.4 | 4.552 |
| 1.1437 | 1.3468 | 17 | 194.4 | 1.155 | 1.5825 | 1.3885 | 50 | 791.3 | 4.700 |
| 1.1536 | 1.3478 | 18 | 207.6 | 1.233 | 1.601 | 1.3903 | 51 | 816.5 | 4.849 |
| 1.1637 | 1.3488 | 19 | 221.1 | 1.313 | 1.619 | 1.3920 | 52 | 841.9 | 5.000 |
| 1.1739 | 1.3498 | 20 | 234.8 | 1.395 | 1.638 | 1.3937 | 53 | 868.1 | 5.156 |
| 1.1843 | 1.3508 | 21 | 248.7 | 1.477 | 1.658 | 1.3955 | 54 | 893.3 | 5.317 |
| 1.1948 | 1.3518 | 22 | 262.9 | 1.561 | 1.6778 | 1.3973 | 55 | 922.8 | 5.481 |
| 1.2055 | 1.3529 | 23 | 277.3 | 1.647 | 1.699 | 1.3992 | 56 | 951.4 | 5.651 |
| 1.2164 | 1.3539 | 24 | 291.9 | 1.734 | 1.720 | 1.4012 | 57 | 980.4 | 5.823 |
| 1.2275 | 1.3550 | 25 | 306.9 | 1.823 | 1.741 | 1.4032 | 58 | 1009.8 | 5.998 |
| 1.2387 | 1.3561 | 26 | 322.1 | 1.913 | 1.763 | 1.4052 | 59 | 1040.2 | 6.178 |
| 1.2502 | 1.3572 | 27 | 337.6 | 2.005 | 1.7846 | 1.4072 | 60 | 1070.8 | 6.360 |
| 1.2619 | 1.3584 | 28 | 353.3 | 2.098 | 1.808 | 1.4093 | 61 | 1102.9 | 6.550 |
| 1.2738 | 1.3596 | 29 | 369.4 | 2.194 | 1.831 | 1.4115 | 62 | 1135.8 | 6.746 |
| 1.2858 | 1.3607 | 30 | 385.7 | 2.291 | 1.856 | 1.4137 | 63 | 1167.3 | 6.945 |
| 1.298 | 1.3619 | 31 | 402.4 | 2.390 | 1.880 | 1.4160 | 64 | 1203.2 | 7.146 |
| 1.311 | 1.3631 | 32 | 419.5 | 2.492 | 1.9052 | 1.4183 | 65 | 1238.4 | 7.355 |
| 1.324 | 1.3644 | 33 | 436.9 | 2.595 | | | | | |

* Computed from the relationship $p^{25} = 10.2402 \eta_D^{25} - 12.6483$ for densities between 1.00 and 1.37, and $p^{25} = 10.8601 \eta_D^{25} - 13.4974$ for densities above 1.37 (Bruner and Vinograd, 1965).

[†] Divide by 10.0 to obtain % w/v.

Density data are from International Critical Tables.

Table C-3. Density, Refractive Index, and Concentration Data—Sucrose at 20°C, Molecular Weight = 342.3

| Density (g/cm ³) | Refractive Index, η_D | % by Weight | mg/mL of Solution* | Molarity | Density (g/cm ³) | Refractive Index, η_D | % by Weight | mg/mL of Solution* | Molarity |
|------------------------------|----------------------------|-------------|--------------------|----------|------------------------------|----------------------------|-------------|--------------------|----------|
| 0.9982 | 1.3330 | 0 | | | 1.1463 | 1.3883 | 34 | 389.7 | 1.138 |
| 1.0021 | 1.3344 | 1 | 10.0 | 0.029 | 1.1513 | 1.3902 | 35 | 403.0 | 1.177 |
| 1.0060 | 1.3359 | 2 | 20.1 | 0.059 | 1.1562 | 1.3920 | 36 | 416.2 | 1.216 |
| 1.0099 | 1.3374 | 3 | 30.3 | 0.089 | 1.1612 | 1.3939 | 37 | 429.6 | 1.255 |
| 1.0139 | 1.3388 | 4 | 40.6 | 0.119 | 1.1663 | 1.3958 | 38 | 443.2 | 1.295 |
| 1.0179 | 1.3403 | 5 | 50.9 | 0.149 | 1.1713 | 1.3978 | 39 | 456.8 | 1.334 |
| 1.0219 | 1.3418 | 6 | 61.3 | 0.179 | 1.1764 | 1.3997 | 40 | 470.6 | 1.375 |
| 1.0259 | 1.3433 | 7 | 71.8 | 0.210 | 1.1816 | 1.4016 | 41 | 484.5 | 1.415 |
| 1.0299 | 1.3448 | 8 | 82.4 | 0.211 | 1.1868 | 1.4036 | 42 | 498.5 | 1.456 |
| 1.0340 | 1.3464 | 9 | 93.1 | 0.272 | 1.1920 | 1.4056 | 43 | 512.6 | 1.498 |
| 1.0381 | 1.3479 | 10 | 103.8 | 0.303 | 1.1972 | 1.4076 | 44 | 526.8 | 1.539 |
| 1.0423 | 1.3494 | 11 | 114.7 | 0.335 | 1.2025 | 1.4096 | 45 | 541.1 | 1.581 |
| 1.0465 | 1.3510 | 12 | 125.6 | 0.367 | 1.2079 | 1.4117 | 46 | 555.6 | 1.623 |
| 1.0507 | 1.3526 | 13 | 136.6 | 0.399 | 1.2132 | 1.4137 | 47 | 570.2 | 1.666 |
| 1.0549 | 1.3541 | 14 | 147.7 | 0.431 | 1.2186 | 1.4158 | 48 | 584.9 | 1.709 |
| 1.0592 | 1.3557 | 15 | 158.9 | 0.464 | 1.2241 | 1.4179 | 49 | 599.8 | 1.752 |
| 1.0635 | 1.3573 | 16 | 170.2 | 0.497 | 1.2296 | 1.4200 | 50 | 614.8 | 1.796 |
| 1.0678 | 1.3590 | 17 | 181.5 | 0.530 | 1.2351 | 1.4221 | 51 | 629.9 | 1.840 |
| 1.0721 | 1.3606 | 18 | 193.0 | 0.564 | 1.2406 | 1.4242 | 52 | 645.1 | 1.885 |
| 1.0765 | 1.3622 | 19 | 204.5 | 0.597 | 1.2462 | 1.4264 | 53 | 660.5 | 1.930 |
| 1.0810 | 1.3639 | 20 | 216.2 | 0.632 | 1.2519 | 1.4285 | 54 | 676.0 | 1.975 |
| 1.0854 | 1.3655 | 21 | 227.9 | 0.666 | 1.2575 | 1.5307 | 55 | 691.6 | 2.020 |
| 1.0899 | 1.3672 | 22 | 239.8 | 0.701 | 1.2632 | 1.4329 | 56 | 707.4 | 2.067 |
| 1.0944 | 1.3689 | 23 | 251.7 | 0.735 | 1.2690 | 1.4351 | 57 | 723.3 | 2.113 |
| 1.0990 | 1.3706 | 24 | 263.8 | 0.771 | 1.2748 | 1.4373 | 58 | 739.4 | 2.160 |
| 1.1036 | 1.3723 | 25 | 275.9 | 0.806 | 1.2806 | 1.4396 | 59 | 755.6 | 2.207 |
| 1.1082 | 1.3740 | 26 | 288.1 | 0.842 | 1.2865 | 1.4418 | 60 | 771.9 | 2.255 |
| 1.1128 | 1.3758 | 27 | 300.5 | 0.878 | 1.2924 | 1.4441 | 62 | 788.3 | 2.303 |
| 1.1175 | 1.3775 | 28 | 312.9 | 0.914 | 1.2983 | 1.4464 | 62 | 804.9 | 2.351 |
| 1.1222 | 1.3793 | 29 | 325.4 | 0.951 | 1.3043 | 1.4486 | 63 | 821.7 | 2.401 |
| 1.1270 | 1.3811 | 30 | 338.1 | 0.988 | 1.3103 | 1.4509 | 64 | 838.6 | 2.450 |
| 1.1318 | 1.3829 | 31 | 350.9 | 1.025 | 1.3163 | 1.4532 | 65 | 855.6 | 2.500 |
| 1.1366 | 1.3847 | 32 | 363.7 | 1.063 | 1.3224 | 1.4558 | 66 | 872.8 | 2.550 |
| 1.1415 | 1.3865 | 33 | 376.7 | 1.100 | 1.3286 | 1.4581 | 67 | 890.2 | 2.864 |

*Divide by 10.0 to obtain % w/v.

Density and refractive index data are from the International Critical Tables.

Table C-4. Density Conversion for Cesium and Rubidium Salts at 20°C

| % w/w | CsCl | CsBr | CsI | Cs ₂ SO ₄ | CsNO ₃ | RbCl | RbBr | RbI | Rb ₂ SO ₄ | RbNO ₃ |
|-------|---------|---------|---------|---------------------------------|-------------------|---------|---------|---------|---------------------------------|-------------------|
| 1 | 1.00593 | 1.00612 | 1.00608 | 1.0061 | 1.00566 | 1.00561 | 1.00593 | 1.00591 | 1.0066 | 1.0053 |
| 2 | 1.01374 | 1.01412 | 1.01402 | 1.0144 | 1.01319 | 1.01307 | 1.01372 | 1.01370 | 1.0150 | 1.0125 |
| 4 | 1.02969 | 1.03048 | 1.03029 | 1.0316 | 1.02859 | 1.02825 | 1.02965 | 1.02963 | 1.0322 | 1.0272 |
| 6 | 1.04609 | 1.04734 | 1.04707 | 1.0494 | 1.04443 | 1.04379 | 1.04604 | 1.04604 | 1.0499 | 1.0422 |
| 8 | 1.06297 | 1.06472 | 1.06438 | 1.0676 | 1.06072 | 1.05917 | 1.06291 | 1.06296 | 1.0680 | 1.0575 |
| 10 | 1.08036 | 1.08265 | 1.08225 | 1.0870 | 1.07745 | 1.07604 | 1.08028 | 1.08041 | 1.0864 | 1.0731 |
| 12 | 1.09828 | 1.10116 | 1.10071 | 1.1071 | 1.09463 | 1.09281 | 1.09817 | 1.09842 | 1.1052 | 1.0892 |
| 14 | 1.11676 | 1.12029 | 1.11979 | 1.1275 | 1.11227 | 1.11004 | 1.11661 | 1.11701 | 1.1246 | 1.1057 |
| 16 | 1.13582 | 1.14007 | 1.13953 | 1.1484 | | 1.12775 | 1.13563 | 1.13621 | 1.1446 | 1.1227 |
| 18 | 1.15549 | 1.16053 | 1.15996 | 1.1696 | | 1.14596 | 1.15526 | 1.15605 | 1.1652 | 1.1401 |
| 20 | 1.17580 | 1.18107 | 1.18112 | 1.1913 | | 1.16469 | 1.17554 | 1.17657 | 1.1864 | 1.1580 |
| 22 | 1.19679 | 1.20362 | 1.20305 | 1.2137 | | 1.18396 | 1.19650 | 1.19781 | 1.2083 | 1.1763 |
| 24 | 1.21849 | 1.22634 | 1.22580 | 1.2375 | | 1.20379 | 1.21817 | 1.21980 | 1.2309 | 1.1952 |
| 26 | 1.24093 | 1.24990 | 1.24942 | 1.2643 | | 1.22421 | 1.24059 | 1.24257 | 1.2542 | 1.2146 |
| 28 | 1.26414 | 1.27435 | 1.27395 | | | 1.24524 | 1.26380 | 1.26616 | 1.2782 | 1.2346 |
| 30 | 1.28817 | 1.29973 | 1.29944 | | | 1.26691 | 1.28784 | 1.29061 | 1.3028 | 1.2552 |
| 35 | 1.35218 | 1.36764 | 1.36776 | | | 1.32407 | 1.35191 | 1.35598 | 1.3281 | 1.2764 |
| 40 | 1.42245 | 1.44275 | 1.44354 | | | 1.38599 | 1.42233 | 1.42806 | | |
| 45 | 1.49993 | 1.52626 | 1.52803 | | | 1.45330 | 1.50010 | 1.50792 | | |
| 50 | 1.58575 | 1.61970 | 1.62278 | | | 1.52675 | 1.58639 | 1.59691 | | |
| 55 | 1.68137 | 1.72492 | | | | | 1.68254 | 1.69667 | | |
| 60 | 1.78859 | | | | | | | 1.80924 | | |
| 65 | 1.90966 | | | | | | | 1.93722 | | |

Blood Component Separation

This Appendix provides a basic overview of blood separation procedures using Beckman Coulter J series centrifuges.

BLOOD BANK COLLECTION OVERVIEW

Blood is composed of plasma, red blood cells (RBC), white blood cells (WBC), and platelets. Approximately 40 to 45 percent of this volume is made up of red blood cells; most of the remainder is plasma, a watery substance that contains vital substances, including hormones and proteins.

Most whole blood collected undergoes fractionation, or separation into components, in order to use collected blood most efficiently. Termed “component therapy,” multiple use of different parts of the blood helps conserve this scarce resource and allows patients to receive only the components they need. As shelf life and storage requirements vary, conditions can be optimized by separating components.

In addition to collection of whole blood for separation into components, several techniques involve collection of whole blood, separation, collection of a fraction for infusion, and return of the remainder to the donor.

- In plasmapheresis a unit of blood is taken to obtain plasma, separated, and the red cells are immediately reinfused to the donor. Most plasmapheresis is performed for “source plasma,” which is not intended for intravenous transfusion, but separated by large-scale fractionation into clotting factors (especially factor VIII), albumin, and specific immunoglobulins.
- During plateletpheresis, whole blood is collected, platelets separated via centrifugations, and platelet-depleted red blood cells returned to the donor. The plasma may be returned to the donor or collected for fractionation into clotting factors and albumin.

- Leukapheresis is the separation of leukocytes, or white blood cells, from whole blood. The leukocyte-depleted and platelet-depleted red blood cells are continuously or intermittently returned to the donor.

COMPONENTS AND TYPICAL USAGE

SINGLE-DONOR FRESH PLASMA

Single-donor fresh plasma is separated from whole blood within 4 to 8 hours after collection. If it is not used immediately, it may be frozen and stored (see SHELF LIFE, below). Fresh and fresh-frozen plasma contain all plasma-clotting factors.

- Fresh plasma—used for the treatment of deficiencies of clotting factors V, XI, and XIII.
- Factor VII Concentrate—separated from platelet-rich plasma, useful for treating clotting deficiencies other than those mentioned above.
- Cryoprecipitated Antihemophilic Factor (factor VIII)—a protein concentrate separated from cell-free plasma (frozen, then thawed at 4°C), useful for treating hemophilia.
- Platelet Concentrates—separated from plasma, platelet concentrates are used to treat decreased platelet counts or failing platelet functions. Platelets must be separated by centrifugation within 6 hours of collection.

SINGLE-DONOR PLASMA

Single-donor plasma can be separated from whole blood up to a few days after the expiration date, since no attempt is made to maintain the activity of the labile clotting factors. This plasma, which may be frozen and kept for up to 5 years, is used for expansion of blood volume (treatment of hypovolemic shock, caused by a dangerous reduction in blood volume).

PACKED RED BLOOD CELLS (RBC)

RBC, required when the oxygen-carrying capacity must be improved without overloading the cardiovascular system with extra fluid volume, are commonly administered to treat anemia.

LEUKOCYTE-DEPLETED RED BLOOD CELLS

These are prepared by removing most leukocytes and platelets from fresh whole blood. Obtained by differential separation, they are given to recipients with antileukocyte antibodies to prevent adverse reactions.

SHELF LIFE

Table D-1 lists approximate storage times for the separated components.

Table D-1. Blood Component Storage

| Component | Approximate Storage Life |
|---|--------------------------|
| RBC with ADSOL | 42 days |
| RBC with SAG-M | 35 days |
| RBC with CPDA-1 | 25 days |
| RBC without preservative | 21 days |
| RBC frozen without addition of cryoprotective agent | 10 days |
| Plasma—frozen | 1 year |

ADSOL = dextrose-sodium chloride-mannitol-adenine

SAG-M = saline-adenine-glucose-minitol

CPDA-1 = citrate-phosphate-dextrose-citrate-citric acid-adenine

FREEZING

A cryoprotective agent such as glycerol can be added to extend the life of frozen red blood cells. These cells can then be stored for up to 3 years at -80°C . Prior to use the cells are thawed and the glycerol is removed by washing.

If the plasma will not be separated within 15 hours of collection, it must be frozen within 6 hours of collection. Freezing must be carried out in a flash freezer with complete freezing accomplished within 1 or 2 hours of the time it is placed in the freezer.

SEPARATION OF BLOOD COMPONENTS BY CENTRIFUGATION

Centrifugation is the primary method for processing blood because it offers the required high throughput, reproducibility, and versatility. Most blood components can be separated in one or two runs. Generally, two types of centrifugation runs are performed (see Figure D-1). Soft spin runs, short centrifugation runs (3 to 5 minutes) at low g -forces (2000 to $3000 \times g$) at ambient temperature, are used to keep small cells or platelets in suspension while the larger cells sediment. This type of run is used to obtain platelet-rich plasma and red blood cell concentrate from whole blood.

Hard spin runs are longer (5 to 7 minutes), at higher g -forces (4000 to $5000 \times g$), at ambient temperature or at 4°C , and are used to separate fresh plasma from cellular components. Soft spin and hard spin techniques are often combined.

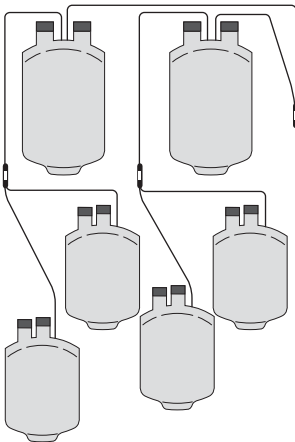

Donor blood is collected in plastic bags with one or more satellite bags (double, triple, or quad packs) containing anticoagulant and preservative. After each centrifugation run, the sedimented fraction is squeezed into its respective satellite bag. Common anticoagulants and preservatives include citrate-phosphate-dextrose (CPD), citrate-phosphate-dextrose-citrate-citric acid-adenine (CPDA-1), saline-adenine-glucose-mannitol (SAG-M), and dextrose-sodium chloride-mannitol-adenine (ADSOL).

Blood separations occur during centrifugation because of particle sedimentation. Using sedimentation theory, users can calculate sedimentation rates. For example, red blood cells settle at the approximate rate of 2 cm per hour in aqueous medium at 1 g , with higher force fields increasing the settling rate. Note that blood cells should not be subjected to high centrifugal force fields, as the cells can be damaged.

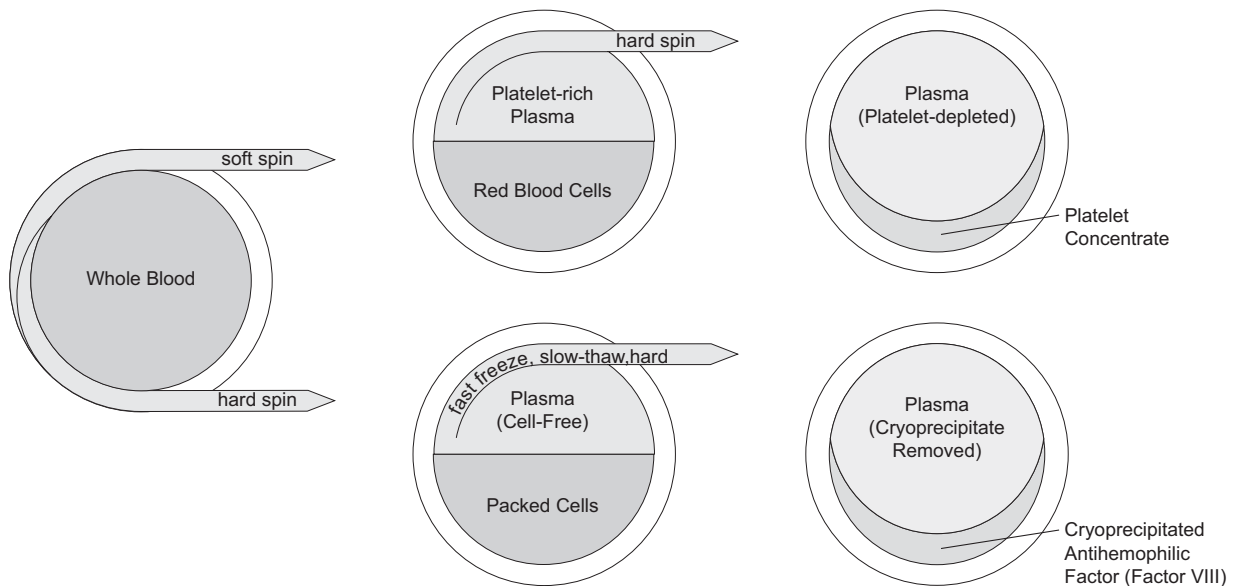

Figure D-1. Blood Component Preparation

Table D-2. Blood Bank Methods. The speeds, times, and brake settings shown here are intended to be guidelines only. Optimum conditions for separating blood components in each centrifuge must be determined by the user before carrying out actual separation runs.

| Blood Components Products | Starting Material | Method | Temperature (°C) | Rotor | Capacity (No. of Cups) | Speed (rpm) | Time ¹ (min) | Brake Setting ² | | |
|--|---|------------------------|------------------|----------|------------------------|-------------|-------------------------|----------------------------|-------|---------|
| | | | | | | | | J6-MI | J6-MC | J6-HC |
| Platelet-Rich Plasma and Red Blood Cells | Whole Blood | Soft Spin ³ | 20 to 22 | JS-4.2 | 6 | 2800 | 3.0 | 6 | 1 | 4.5–5.5 |
| | | | | JS-4.2SM | 6 | 2850 | 3.0 | 6 or 7 | 1 | 4.5–5.5 |
| | | | | JS-5.2 | 4 | 3000 | 2.9 | 6 | 1 | 4.5–5.5 |
| Platelet Concentrate | Platelet-Rich Plasma | Hard Spin ³ | 20 to 22 | JS-4.2 | 6 | 3850 | 6.0 | 6 | 1 | 4.5–5.5 |
| | | | | JS-4.2SM | 6 | 3900 | 6.0 | 6 or 7 | 1 | 4.5–5.5 |
| | | | | JS-5.2 | 4 | 4100 | 6.0 | 6 | 1 | 4.5–5.5 |
| Plasma (Cell-free) and Packed Cells | Whole Blood | Hard Spin | 4 | JS-4.2 | 6 | 3850 | 6.0 | 6 | 1 | 4.5–5.5 |
| | | | | JS-4.2SM | 6 | 3900 | 6.0 | 6 or 7 | 1 | 4.5–5.5 |
| | | | | JS-5.2 | 4 | 4100 | 6.0 | 6 | 1 | 4.5–5.5 |
| Cryoprecipitated Antihemophilic Factor | Plasma (Cell-free) (frozen, and then thawed at 4°C) | Hard Spin | 4 | JS-4.2 | 6 | 4200 | 7.2 | Max. | Max. | Max. |
| | | | | JS-4.2SM | 6 | 4200 | 7.5 | Max. | Max. | Max. |
| | | | | JS-5.2 | 4 | 4500 | 7.1 | Max. | Max. | Max. |

¹ Times include acceleration and time at maximum speed only. Deceleration time is not included.

² Brake settings are estimated for a rotor fully loaded with 500-mL blood bags. When using other bags, brake settings should be increased to maintain comparable deceleration times.

³ Several methods for preparation of platelet-rich plasma and platelet concentrate are in current use. The speed and time ranges given have been estimated to be comparable to conditions specified in the following sources:

American Association of Blood Banks. *Technical Manual*, p. 359. 7th ed. Washington, 1977.
 Humphreys, P. Private communication. Canadian Red Cross Society, Toronto, Ontario. (July 1977)
 Kahn, R.A., Cossette, I., Friedman, L. I. *Transfusion* 16, 162-165 (1976)
 Reiss, R. F., Katz, A. J. *Transfusion* 16, 370-374 (1976)
 Slichter, S. J., Harker, L. A. *Transfusion* 16, 8-12 (1976)

Beckman Coulter has centrifuges, rotors, and accessories designed to fit the special needs of blood component processing. Several rotors are available to accommodate single, double, triple, and quad blood bags. Blood bag cups rest in the rotor bucket and simplify processing, since they eliminate the need to remove buckets after each run. They also minimize clean-up downtime if a bag breaks—simply remove the cup and resume the run. Refer to the applicable rotor manual for blood bag cups used with each rotor. Table D-2 lists blood bank methods that can be used for separating components in a variety of J6 series centrifuges.

TIPS FOR OPTIMUM CENTRIFUGATION RUNS

Centrifugation generates high speeds, causing rotor heads and buckets to develop a gravity force of thousands of pounds. Observing the following tips will ensure safe and efficient operation.



WARNING

Handle body fluids with care because they can transmit disease. No known test offers complete assurance that body fluids are free of micro-organisms. Some of the most virulent—Hepatitis (B and C) and HIV (I–V) viruses, atypical mycobacterium, and certain systemic fungi—further emphasize the need for aerosol protection.

- Never lift the centrifuge door while the instrument is running.
- Keep metal clips, needle holders, and sealed tube ends away from blood bags.
- Load opposing cups with equal weight, to ensure safety, optimum run efficiency, and long rotor life.
- Use weighted rubber disks for balancing.
- Load filled bags towards the outside wall of the bucket, away from the centrifuge drive spindle. Place the ADSOL bag between the blood bag and the plasma bag.

Glossary of Terms

| | |
|----------------------------|---|
| ADSOL | dextrose-sodium chloride-mannitol-adenine; an additive used as a stabilizer for red blood cells that extends red cell life in CPD |
| angular velocity, ω | rate of rotation, measured in radians per second $\omega = \frac{2\pi \text{ rpm}}{60}$ <p>or</p> $\omega = 0.10472 \text{ rpm}$ |
| anodized coating | a thin, hard layer of aluminum oxide formed electrochemically on aluminum rotor and/or accessory surfaces as a protective coating for corrosion resistance |
| autoclaving | sterilization by heat (dry or steam) |
| buoyant density | the density of a particle in a specified liquid medium |
| Buna N | black nitrile rubber used for O-rings and gaskets in rotor assemblies; should be used at temperatures between -34 and 121°C (-30 and 250°F) |
| centrifugal effect | accumulated value of: $\int_{t_1}^{t_2} \omega^2 dt$ <p>where t is time and ω is angular velocity</p> |
| centrifugal force | in a centrifugal field, the force which causes a particle to move away from the center of rotation |

| | |
|-------------------------|---|
| clearing factor, k | calculated for all Beckman Coulter high-speed rotors as a measure of the rotor's relative pelleting efficiency: $k = \frac{\ln(r_{\max}/r_{\min})}{\omega^2} \times \frac{10^{13}}{3600}$ or $k = \frac{253303 \times \ln(r_{\max}/r_{\min})}{(\text{RPM} / 1000)^2}$ |
| clearing time, t | $t = k/s$, where t is time in hours, k is the clearing factor of the rotor, and s is the sedimentation coefficient in Svedberg units (S) |
| CPD | citrate-phosphate-dextrose; anti-coagulant and preservative |
| CPDA-1 | citrate-phosphate-dextrose-citrate-citric acid-adenine; anti-coagulant and preservative |
| cryoprecipitate | a precipitate, such as cryoglobulin or antihemophilic factor VIII, that results from cooling |
| CsCl | cesium chloride; a high-density salt used in solution in isopycnic separations to separate particles based on their density |
| CsSO | cesium sulfate; a salt, similar to CsCl, that will form its own gradient in solution |
| Delrin | thermoplastic material (acetal homopolymer) used for most tube adapters (Delrin is a registered trademark of E.I. Du Pont de Nemours & Company.) |
| density | mass per unit volume |
| density separation | a centrifugal separation process based on differences in particle densities |
| differential separation | a centrifugal separation process based on differences in particle sizes |
| EPDM | ethylene propylene rubber used for O-rings and pad adapters; should be used at temperatures between -57 and 120°C (-70 and 250°F) |
| erythrocytes | see RBC (red blood cells) |

| | |
|-------------------|---|
| ethidium bromide | a fluorescent intercalating orange dye used commonly in the separation of DNA and in gel electrophoresis |
| fixed angle rotor | a rotor in which the tubes are held at an angle (usually 20 to 45 degrees) from the axis of rotation |
| granulocytes | generic name for three leukocyte (white blood cell) types characterized by having granules in their cytoplasm |
| hard spin | centrifugation run (5 to 7 minutes), at high <i>g</i> -forces (4000 to 5000 × <i>g</i>) at ambient temperature or at 4°C, used to separate fresh plasma from cellular components |
| HDPE | high density polyethylene used for adapters |
| isopycnic | a method of particle separation or isolation based on particle buoyant density; particles are centrifuged until they reach a point in the gradient where the density of the particle is the same as the density of the gradient at that point |
| LDPE | low density polyethylene used for tubes and bottles |
| leukopheresis | procedure in which leukocytes, or white blood cells, are separated from whole blood |
| leukocytes | see WBC (white blood cells) |
| lymphocyte | a type of leukocyte formed in the lymph nodes, other lymphoid tissue, and bone marrow; about a quarter of the white blood cells in the circulating blood are lymphocytes |
| maximum volume | the maximum volume at which a tube should be filled for centrifugation (sometimes referred to as maximum fill volume or nominal fill volume) |
| meniscus | the curved upper surface of a liquid column that is concave when the container walls are wetted by the liquid and convex when they are not |
| NaCl | sodium chloride; a lower-density salt than CsCl, primarily used in lipoprotein type separations |
| neoprene | black synthetic elastomer used for O-rings in some tube caps and bottle cap assemblies; should be used at temperatures between -54 and 121°C (-65 and 250°F) |

| | |
|------------------|--|
| Noryl | modified polyphenylene oxide used in some bottle caps (Noryl is a registered trademark of GE Plastics.) |
| pelleting | a centrifugal separation process in which particles in a sample sediment to the bottom of the tube (differential separation); differential pelleting separates particles of different sizes by successive centrifugation steps of progressively higher <i>g</i> force and/or longer run duration |
| PET | polyethylene terephthalate used in some adapters |
| plasma | major component of blood made up primarily of water, with substances such as albumin, globulins, coagulation factors, and electrolytes; distributes nutrients to the body, absorbs and carries away waste products |
| plasmapheresis | procedure in which whole blood is collected, platelets are separated via centrifugation, and platelet-poor red blood cells are returned to the donor; plasma is returned to the donor or collected for fractionation into clotting factors and albumin |
| plateletpheresis | procedure in which a unit of blood is taken to obtain plasma; following blood separation, red cells are immediately reinfused to the donor |
| platelets | blood component responsible for blood coagulation |
| polyallomer | random block copolymer of ethylene and propylene used for certain tubes (Tenite Polyallomer is a registered trademark of Eastman Chemical Co.) |
| rack-type rotor | a rotor in which tubes are placed in gamma-counter racks; the racks are loaded into special plastic trays, which are then loaded into carriers that swing up to the horizontal position during centrifugation |
| Radel | polyphenylsulfone (PPS) used in plugs, cap closures, cannisters and other accessories |
| rate zonal | a method of particle separation, based on differential rate of sedimentation, using a preformed gradient with the sample layered as a zone on top of the gradient |
| RBC | red blood cells, or erythrocytes, carry oxygen to the tissues and carbon dioxide to the lungs for exhalation |

RCF relative centrifugal field; the ratio of the centrifugal acceleration at a specified radius and speed ($r\omega^2$) to the standard acceleration of gravity (g) according to the following equation:

$$\text{RCF} = \frac{r\omega^2}{g}$$

where r is the radius in millimeters, ω is the angular velocity in radians per second ($2\pi\text{RPM}/60$), and g is the standard acceleration of gravity (9807 mm/s^2). Thus the relationship between RCF and RPM is:

$$\text{RCF} = 1.12r \left(\frac{\text{RPM}}{1000} \right)^2$$

r_{max} (maximum radius) the position of the liquid in the tube at the maximum distance from the axis of rotation when the rotor is at speed

r_{min} (minimum radius) the position of the liquid in the tube at the minimum distance from the axis of rotation when the rotor is at speed

SAG-M saline-adenine-glucose-minitol; an additive used as a stabilizer for red cells that extends red cell life in CPD

sedimentation the settling out of particles from a suspension in the earth's field of gravity; in the centrifuge this process is accelerated and the particles move away from the axis of rotation

sedimentation coefficient, s sedimentation velocity per unit of centrifugal force:

$$s = \frac{dr}{dt} \times \frac{1}{\omega^2 r}$$

SDS sodium dodecyl sulfate; an ionic detergent used in cell lysis and solubilizing of proteins

silicone rubber a large group of silicone elastomers used in various accessories; should be used at temperatures between -59 and 232°C (-75 and 450°F)

soft spin short centrifugation run (3 to 5 minutes), at low g -forces (2000 to $3000 \times g$) at ambient temperature, used to keep small cells or platelets in suspension while the larger cellular components sediment; used to obtain platelet-rich plasma and red blood cell concentrate from whole blood

Solution 555™ Beckman Coulter concentrated rotor cleaning solution; recommended because it is a mild solution that has been tested and found effective and safe for Beckman Coulter rotors and accessories

| | |
|-------------------------|---|
| Spinkote™ | Beckman Coulter lubricant for metal-to-metal contacts |
| sucrose | a sugar (not a self-forming gradient) used in rate zonal separations; generally used in separating RNA, subcellular organelles, and cell membranes |
| supernatant | the liquid above the sedimented material following centrifugation |
| Svedberg unit, <i>S</i> | a unit of sedimentation velocity: $1 S = 10^{-13}$ seconds |
| swinging bucket rotor | a rotor in which the tubes or bottles are carried in buckets, microtiter plate carriers, or racks that swing up to the horizontal position during centrifugation (sometimes referred to as a horizontal or swing-out rotor) |
| Ultem | polyetherimide (PEI)—used in adapters, covers, and spacers; should be used at temperatures between -29 and 204°C (-20 and 400°C) (Ultem is a registered trademark of GE Plastics.) |
| vertical tube rotor | a rotor in which the tubes or bottles are held parallel to the axis of rotation |
| Viton | fluorocarbon elastomer used in high-temperature applications (Viton is a registered trademark of E.I. Du Pont de Nemours & Company.) |
| WBC | white blood cells, or leukocytes, protect the body against infection and many diseases |
| wettable | tube or bottle material that water or other aqueous solution will adhere to; the more wettable a tube or bottle material is, the more biological material, DNA, protein, cells, and so forth, will adhere to the walls |

Appendix F

References

Documents referenced below¹ can be obtained by calling Beckman Coulter at 1-800-742-2345 in the United States, or by contacting your local Beckman Coulter office.

IN-181 *How to use Quick-Seal[®] Tubes with the Beckman Coulter Cordless Tube Topper[™].*

IN-192 *Use and Care of Centrifuge Tubes and Bottles*

Documents referenced below are available upon request from:

Beckman Coulter, Inc.
Marketing Communications
4300 N. Harbor Blvd., Box 3100
Fullerton, CA 92834 U.S.A.

or are available at www.beckmancoulter.com

A-1792 *Rapid Pelleting of Bacteria in the Avanti[®] J Centrifuge*

A-1796 *Rapid Protease Screening Using Ammonium Sulfate Precipitation and the Avanti J-25 High Performance Centrifuge*

A-1803 *Isolation of Mitochondria from *Saccharomyces Cerevisiae* Using the Avanti J High Performance Centrifuge A-1817*

Isolation of Plasma Membrane Sheets Using the Avanti J-30I High Performance Centrifuge

A-1818 *Baculovirus Purification Using the Avanti J-30I Centrifuge with the JS-24.38 and JS-24.15 Rotors*

A-1836 *Rapid Pelleting of Bacteria and Other Solids in the Avanti J-20 or J-20I Centrifuge*

¹ For detailed information on a rotor, see the applicable individual rotor manual.

References

- A-1837 *Large- or Small-Scale Isolation of Chloroplasts Using the Avanti J Series of High Performance Centrifuges*
- A-1857 *Use of the JS-4.2 ARIES Self-Balancing Rotor in Blood Component Manufacturing*
- A-1930 *Blood Cell Separation Using Commercial Gradient*
- A2036 *Biocontainment Capability of the AeroSeal Covers for the JS-5.3 Rotor*
- BR-8102 *High Performance, High Speed, High Capacity Rotors, Tubes & Accessories*
- DS-528 *Use of the ω^2t Integrator*
- DS-719 *Use of k Factor for Estimating Run Times*
- DS-763 *Plasmid DNA Mini-Preparation Using the JA-18.1 Rotor*
- DS-764 *Process 50 Liters of Sample in a Simple Run*
- DS-769 *Multitube Carrier Adds Versatility*
- DS-776 *Using k Factor to Compare Efficiency of Fixed Angle Rotors*
- DS-787 *New 4 × 50 mL Multitube Carrier for JS-7.5 Rotor*
- DS-797 *New Large-Capacity Multitube Carrier Holds 12 × 75 mm Tubes in the JS-7.5 Rotor*
- DS-828 *Using k Factors to Compare Rotor Efficiency*
- DS-829 *Method for Plasmid DNA Mini-Preparation Using the JA-18.1 Rotor*
- DS-885 *Using the JA-18 Rotor to Process Large Volumes Rapidly*
- DS-916 *Discovery Video Series, “Principles and Practices of Centrifugation”*
- DS-917 *JS-4.3 Rotor*
- DS-7939 *MicroPlus Carrier*

| | |
|---------|--|
| DS-8028 | <i>The JLA-10.500 Rotor with 3-Liter Capacity</i> |
| DS-8056 | <i>Avanti® J-25 Rotor Data Sheet</i> |
| DS-8110 | <i>Avanti® JS-24.15 and 24.38 Data Sheet</i> |
| DS-8113 | <i>JLA 16.250 Rotor Data Sheet</i> |
| DS-8141 | <i>Avanti® JA-30.50 Ti Data Sheet</i> |
| DS-8185 | <i>JLA-8.1000 Rotor Data Sheet</i> |
| DS-8225 | <i>JLA 9.1000 Rotor Data Sheet</i> |
| DS-8247 | <i>JS-4.2A and JS-4.2SMA</i> |
| DS-8897 | <i>JS-5.3 4-Place Swinging-Bucket Rotor for Avanti J-20XP</i> |
| DS-8898 | <i>HarvestLine System Liners</i> |
| DS-8901 | <i>JS-5.9 2-Place Swinging-Bucket Rotor for Avanti J-25 Series and J-30I</i> |
| DS-9240 | <i>AllSpin™ JS-5.3 Rotor for Avanti J-E and J-26XP Centrifuges</i> |
| DS-9876 | <i>Avanti J Series of BioSafe Centrifuge Systems</i> |
| DS-9980 | <i>Avanti J-26 XP Series High-Performance Centrifuges</i> |
| DS-9982 | <i>High Performance Rotors: Accelerate Your Sample Throughput and Increase Your Labs Versatility</i> |
| DS-9983 | <i>Avanti J-30I High-Performance Centrifuge and Avanti J-HC High Capacity Bioprocessing Centrifuge Systems</i> |
| DS10009 | <i>Avanti J-25 Series High-Performance Centrifuges</i> |
| FL-9987 | <i>F10BCI 6x500y FIBERLite Carbon Fiber Rotor for Avanti J Series High-Performance Centrifuges</i> |
| SB-812 | <i>J6 Series High-Capacity Centrifuges</i> |

References

- T-1735 *Modification of the Model J6-MC for Blood Component Preparation*
- T-1741 *Optimizing Radioimmunoassays with the JR-3.2 Rack Rotor*
- T-1783 *Higher Performance: The New Avanti J Series Switched Reluctance Drive*
- T-1787 *Friction Reduction System Advantages in High-Performance Centrifugation*
- T-1797 *Moving “High Speed” to Higher Performance Centrifugation: Applications History to Avanti J Series Performance*

J SERIES ROTOR WARRANTY

Subject to the conditions specified below and the warranty clause of the Beckman Coulter, Inc., terms and conditions of sale in effect at the time of sale, Beckman Coulter, Inc. agrees to correct either by repair, or, at its election, by replacement, any defects of material or workmanship which develop within seven (7) years after delivery of a J series rotor to the original buyer by Beckman Coulter, Inc. or by an authorized representative, provided that investigation and factory inspection by Beckman Coulter, Inc. discloses that such defect developed under normal and proper use. Should a Beckman Coulter centrifuge be damaged due to a failure of a rotor covered by this warranty, Beckman Coulter will supply free of charge all centrifuge parts required for repair.

REPLACEMENT

Any product claimed to be defective must, if requested by Beckman Coulter, Inc., be returned to the factory, transportation charges prepaid, and will be returned to Buyer with the transportation charges collect unless the product is found to be defective, in which case Beckman Coulter, Inc. will pay all transportation charges.

A defective rotor will be replaced by Beckman Coulter, Inc. at its then current list price less a credit based upon the age of the rotor (years since date of purchase). The Buyer shall not receive credit until the claimed defective rotor is returned to Beckman Coulter's Palo Alto, California, facility or delivered to a Beckman Field Service representative.

The replacement price (cost to Buyer) for the respective rotor shall be calculated as follows:

$$\text{Replacement price} = \text{Current rotor list price} \times \frac{\text{years}}{7}$$

CONDITIONS

1. Except as otherwise specifically provided herein, this warranty covers the rotor only and Beckman Coulter, Inc. shall not be liable for damage to accessories or ancillary supplies including but not limited to (i) tubes, (ii) tube caps, (iii) tube adapters, or (iv) tube contents.

2. This warranty is void if the rotor has been subjected to customer misuse such as operation or maintenance contrary to the instructions in the Beckman Coulter rotor or centrifuge manual.
3. This warranty is void if the rotor is operated with a rotor drive unit or in a centrifuge unmatched to the rotor characteristics, or is operated in a Beckman Coulter centrifuge that has been improperly disassembled, repaired, or modified.
4. Each bucket, whether purchased with a rotor assembly or purchased separately, is covered by this warranty for seven (7) years from the date of purchase, and will be replaced or repaired during such period according to the terms and conditions of this warranty. The date of manufacture marked on the bucket may be earlier than the date of purchase, and the expiration date marked on the bucket, which is seven (7) years after the date of purchase, may be correspondingly offset.
5. Buckets should not be used after the expiration date marked on the bucket. If at the time of purchase the marked expiration date is less than 7 years from the date of purchase, the expiration date becomes the date of purchase plus seven (7) years. Use of a bucket after such expiration date voids Beckman Coulter's warranty obligations with respect to any rotor and/or centrifuge in which such a bucket is used.

DISCLAIMER

IT IS EXPRESSLY AGREED THAT THE ABOVE WARRANTY SHALL BE IN LIEU OF ALL WARRANTIES OF FITNESS AND OF THE WARRANTY OF MERCHANTABILITY AND THAT BECKMAN COULTER, INC. SHALL HAVE NO LIABILITY FOR SPECIAL OR CONSEQUENTIAL DAMAGES OF ANY KIND WHATSOEVER ARISING OUT OF THE MANUFACTURE, USE, SALE, HANDLING, REPAIR, MAINTENANCE, OR REPLACEMENT OF THE PRODUCT.

Beckman Coulter Worldwide Biomedical Research Division Offices

AUSTRALIA

Beckman Coulter Australia Pty Ltd
Unit D, 24 College St.
Gladesville, NSW 2111
Australia
Telephone: (61) 2 9844-6000
or toll free: 1 800 060 880
Fax: (61) 2 9844-6096
email: lifescienceaustralia@beckman.com

CANADA

Beckman Coulter (Canada) Inc.
6755 Mississauga Road, Suite 600
Mississauga, Ontario
Canada L5N 7Y2
Telephone: (1) 905 819-1234
Fax: (1) 905 819-1485

CHINA

Beckman Coulter Inc.
Beijing Representative Office
Unit 2005A, 2006-2009, East Ocean Center
Jian Guomenwai Avenue
Beijing 100004
China
Telephone: (86) 10 6515 6028
Fax: (86) 10 6515 6025, 6515 6026

CZECH REPUBLIC

Beckman Coulter Prague
Radiova 1
102 27 Prague 10
Czech Republic
Telephone: (420) 267 00 85 13
Fax: (420) 267 00 83 23

EASTERN EUROPE/ MIDDLE EAST/NORTH AFRICA

Beckman Coulter International S.A.
22, Rue Juste-Olivier
Case Postale 301-303
CH-1260 Nyon, Switzerland
Telephone: (41) 22 365 3707
Fax: (41) 22 365 0700

FRANCE

Beckman Coulter France S.A.
Paris Nord II, 33/66 rue des Vanesses
B.P. 50359
Villepinte, France
95942 ROISSY CDG Cedex
Telephone: (33) 1 49 90 90 00
Fax: (33) 1 49 90 90 10
e-mail: bioresearch.france@beckman.com

GERMANY

Beckman Coulter GmbH
Europark Fichtenhain B-13
47807 Krefeld
Germany
Telephone: (49) 21 51 33 35
Fax: (49) 21 51 33 33
e-mail: bioresearch.de@beckman.com

HONG KONG

Beckman Coulter Hong Kong Ltd.
12th Floor, Oxford House
979 King's Road
Taikoo Place, Hong Kong
Telephone: (852) 2814 7431
Fax: (852) 2873 4511

INDIA

Beckman Coulter India Pvt. Ltd.
Solitaire Corporate Park
3rd Floor - Bldg. 11
Andheri Ghatkopar Link Road
Chakala, Andheri West
Mumbai India 400 098
Telephone: (91) 22 3080 5101

ITALY

Beckman Coulter S.p.a.
Centro Direzionale Lombardo
Palazzo F/1, Via Roma 108
20060 Cassina de' Pecchi
Milano, Italy
Telephone: (39) 02 953921
Fax: (39) 02 95392264

JAPAN

Beckman Coulter K.K.
TOC Ariake West Tower
2-5-7, Ariake, Koto-ku
Tokyo 135-0063 Japan
Telephone: (81) 3 5530 8500
Fax: (81) 3 5404 8436

MEXICO

Beckman Coulter de Mexico S.A. de C.V.
Avenida Popocatépetl #396
Colonia Gral. Pedro Maria Anaya
Codigo Postal 03340
Mexico, D.F. Mexico
Telephone: (001) 52-55-9183-2800

NETHERLANDS

Beckman Coulter Nederland B.V.
Nijverheidsweg 21
3641 RP-Mijdrecht
Postbus 47
3640 AA Mijdrecht
The Netherlands
Telephone: (31) 297-230630
Fax: (31) 297-288082

SINGAPORE

Beckman Coulter Singapore Pte. Ltd.
116 Changi Road
Unit #03-01/02
Singapore 419718
Telephone: (65) 6339 3633
Fax: (65) 6336 6303

SOUTH AFRICA/SUB-SAHARAN AFRICA

Beckman Coulter
Stand 1A Primegro Park
Tonetti Street
1685 Halfway House
Johannesburg
Republic of South Africa
Telephone: (27) 11-805-2014/5
Fax: (27) 11-805-4120
e-mail: beckman@intekom.co.za

SPAIN

Beckman Coulter España S.A.
C/ Caleruega, 81
28033 Madrid, Spain
Telephone: (34) 91 3836080
Fax: (34) 91 3836096
email: bioresearch.espana@beckman.com

SWEDEN

Beckman Coulter AB
Archimedesvaegen 7
Box 111 56
SE-168 11 Bromma
Sweden
Telephone: (46) 8 564 85 900
Telefax: (46) 8 564 85 901

SWITZERLAND

Beckman Coulter International S.A.
22, Rue Juste-Olivier
Case Postale 301-303
CH-1260 Nyon
Switzerland
Telephone: (41) 0800 850 810
Fax: (41) 0848 850 810

TAIWAN

Beckman Coulter Taiwan Inc.
Taiwan Branch
8th Floor
216 Tun Hwa South Road, Section 2
Taipei 106, Taiwan
Republic of China
Telephone: (886) 2 2378 3456
Fax: (886) 2 2377 0408

TURKEY

Beckman Coulter Ltd.
E-5 Yanyol Faith Cad.
81410 Soganklik Kartal
Istanbul
Turkey
Telephone: (90) 216 309 1900
Fax: (90) 216 309 0090

UNITED KINGDOM

Beckman Coulter United Kingdom Ltd
Oakley Court
Kingsmead Business Park
London Road
High Wycombe
Buckinghamshire HP11 1JU
England, U.K.
Telephone: (44) 01494 441181
Fax: (44) 01494 447558
e-mail: beckman_uk@beckman.com

*Additional addresses are available at
www.beckmancoulter.com.*



Beckman Coulter, Inc. • 4300 N. Harbor Boulevard, Box 3100 • Fullerton, California 92834-3100
Sales and Service: 1-800-742-2345 • Internet: www.beckmancoulter.com • Telex: 678413 • Fax: 1-800-643-4366

