

**Thermo Scientific
Heratherm
General Protocol
Microbiological Incubators**

IGS 60/100/180

Operating Instructions

50125546

10/25/10



© 2010 Thermo Fisher Scientific Inc. All rights reserved.

These operating instructions are protected by copyright. Rights resulting thereof, particularly reprint, photomechanical or digital postprocessing or reproduction, even in part, are only allowed with the written consent of Thermo Fisher Scientific.

This regulation does not apply to reproductions for in-plant use.

The contents of this operating instructions manual may change at any time and without any prior notice. In case of conflicting translations into foreign languages the German-language version of these operating instructions shall be binding.

Trademarks

Heratherm™ is a registered trademark of Thermo Scientific.

Thermo Scientific is a brand owned by Thermo Fisher Scientific, Inc.

All other trademarks mentioned in the operating instructions are the exclusive property of the respective manufacturers.

Thermo Fisher Scientific
Robert-Bosch-Straße 1
D - 63505 Langenselbold
Germany

Thermo Electron LED GmbH is an affiliate to:
Thermo Fisher Scientific Inc.
81 Wyman Street
Waltham, MA 02454
USA

Thermo Fisher Scientific Inc. provides this document to its customers with a product purchase to use in the product operation. This document is copyright protected and any reproduction of the whole or any part of this document is strictly prohibited, except with the written authorization of Thermo Fisher Scientific Inc.

The contents of this document are subject to change without notice.

All technical information in this document is for reference purposes only. System configurations and specifications in this document supersede all previous information received by the purchaser.

Thermo Fisher Scientific Inc. makes no representations that this document is complete, accurate or error-free and assumes no responsibility and will not be liable for any errors, omissions, damage or loss that might result from any use of this document, even if the information in the document is followed properly.

This document is not part of any sales contract between Thermo Fisher Scientific Inc. and a purchaser. This document shall in no way govern or modify any Terms and Conditions of Sale, which Terms and Conditions of Sale shall govern all conflicting information between the two documents.

Contents

Chapter 1	Safety Notes	1-1
	Basic Operating Precautions	1-1
	Operational Safety Rules	1-2
	Warranty	1-2
	Explanation of Safety Information and Symbols	1-3
	Safety Notes and Symbols Used Throughout These Operating Instructions	1-3
	Additional Symbols for Safety Information	1-4
	Symbols on the Incubator	1-5
	Intended Purpose of the Incubator	1-6
	Correct Use	1-6
	Incorrect Use	1-6
	Standards and Directives	1-6
Chapter 2	Delivery of the Incubator	2-1
	Packaging	2-1
	Acceptance Inspection	2-1
	Scope of Supply	2-2
Chapter 3	Installation	3-1
	Ambient Conditions	3-1
	Location Requirements	3-1
	Intermediate Storage	3-2
	Room Ventilation	3-2
	Space Requirements	3-2
	Transport	3-3
	Stacking	3-5
	Stacking Instructions	3-5
Chapter 4	Product Description	4-1
	Heratherm IGS Series Incubator Overview	4-1
	Safety Devices	4-3
	Work Space Atmosphere	4-3
	Sensing and Control System	4-3
	Data Communications & Alarm Interface	4-4
	RS-232 Interface	4-4
	Alarm Contact	4-4
	AC Power Socket	4-5
	Fuses	4-5
	Work Space Components	4-5
	Inner Chamber	4-5

Chapter 5 Start-up	5-1
Installing the Shelf System	5-1
Initial installation	5-1
Installing the Perforated Sheet Shelves	5-2
Preparing the Work Space	5-2
Installation or Removal of the Support Rails.....	5-3
Installing the Shelf Supports	5-3
Installing the Perforated Sheet Shelves	5-4
Levelling the Incubator	5-4
Connecting Power	5-5
Connecting the RS-232 Interface	5-6
Chapter 6 Operation	6-1
Preparing the Incubator.....	6-1
Starting Operation.....	6-1
Chapter 7 Handling and Control	7-1
Powering Up	7-5
Switching the Incubator Off / Powering Down	7-5
Temperature Set Value	7-6
Timer	7-7
Stopping a Timer.....	7-8
Settings.....	7-10
Error Log.....	7-10
Calibration	7-11
Temperature Display Unit.....	7-12
Chapter 8 Shut-down	8-1
Shutting the Incubator Down.....	8-1
Chapter 9 Cleaning and Disinfection	9-1
Cleaning.....	9-1
Wipe / Spray Disinfection	9-1
Preparing the Manual Wipe/Spray Disinfection	9-2
Predisinfection.....	9-3
Cleaning.....	9-3
Final Disinfection.....	9-3
Chapter 10 Maintenance	10-1
Inspections and Checks	10-1
Service Intervals.....	10-2
Preparing Temperature Calibration	10-2
Comparison Measurement Procedure.....	10-3
Temperature Calibration Procedure	10-3
Replacing the Door Seal	10-4
Replacing the Power Cord.....	10-4
Returns for Repair	10-5
Chapter 11 Disposal	11-1
Overview of Materials Used.....	11-1

WEEE Conformity 11-2

Chapter 12 Error Codes 12-1

Chapter 13 Technical Data..... 13-1

Chapter 14 Spare Parts and Accessories 14-1

Chapter 15 Device Log..... 15-1

Chapter 16 Contact..... 16-1

List of Figures

Figure 3-1 Incubator Dimensions and Required Clearances.....	3-3
Figure 3-2 Lift Points.....	3-4
Figure 3-3 Stacking Heratherm Devices.....	3-5
Figure 4-1 Heratherm IGS Front View.....	4-1
Figure 4-2 Heratherm IGS Rear View.....	4-2
Figure 4-3 Sensor System.....	4-3
Figure 4-4 Signal Interfaces and Power Socket.....	4-4
Figure 4-5 Shelf System.....	4-6
Figure 5-1 Sliding the Retaining Spring into the Support Rail.....	5-1
Figure 5-2 Installing the Shelving.....	5-2
Figure 5-3 Support Rail Installation.....	5-3
Figure 5-4 Shelf Support Installation.....	5-4
Figure 5-5 Perforated Sheet Shelf.....	5-4
Figure 5-6 AC Power Supply Socket.....	5-6
Figure 7-1 Control Panel for Heratherm IGS Series Incubators.....	7-1
Figure 10-1 Door Seal Replacement.....	10-4

List of Figures

Safety Notes

Basic Operating Precautions

These operating instructions describe Heratherm incubators.

Heratherm incubators have been manufactured to the latest state of the art and been tested thoroughly for flawless functioning prior to shipping. However, the incubator may present potential hazards, particularly if it is operated by inadequately trained personnel or if it is not used in accordance with the intended purpose. Therefore, the following must be observed for the sake of accident prevention:

- Heratherm incubators must be operated by adequately trained and authorized professional personnel.
- Heratherm incubators must not be operated unless these operating instructions have been fully read and understood.
- The present operating instructions, applicable safety data sheets, plant hygiene guidelines and the corresponding technical rules issued by the operator shall be used to create written procedures targeted at personnel working with the subject matter device, detailing:
 - the decontamination measures to be employed for the incubator and the accessories used with it,
 - the safety precautions to be taken when processing specific agents,
 - the measures to be taken in case of accidents.
- Repair work on the incubator must be carried out only by trained and authorized expert personnel.
- The contents of these operating instructions are subject to change at any time without further notice.
- Concerning translations into foreign languages, the German version of these operating instructions is binding.
- Keep these operating instructions close to the incubator so that safety instructions and important information are always accessible.
- Should you encounter problems that are not detailed adequately in these operating instructions, please contact Thermo Electron LED GmbH immediately for your own safety.

Operational Safety Rules

The following rules must be heeded when working with Heratherm incubators:

- Observe the sample weight limits specified for your Heratherm incubator as a whole and its shelving in particular; see [Chapter 13, “Technical Data.”](#)
- Do not overload the bottom of the interior workspace to avoid the risk of overheating any samples placed there and to prevent the temperature sensor from being damaged.
- Arrange the samples evenly throughout the work space, making sure not to place them too closely to the interior walls to ensure a uniform temperature distribution.
- Do not load your Heratherm incubator with substances that exceed the capabilities of the available lab apparatus and Personal Protection Equipment to provide sufficient degrees of protection to users and third parties.
- Check the door seal every six months for proper sealing performance and possible damage.
- Do not process any samples containing hazardous chemical substances that may be released into the ambient air through defective seals or may cause corrosion or other defects on parts of the Heratherm incubator.

Warranty





Thermo Fisher Scientific warrants the operational safety and functions of the Heratherm incubators only under the condition that:

- the incubator is operated and serviced exclusively in accordance with its intended purpose and as described in these operating instructions,
- the incubator is not modified,
- only original spare parts and accessories that have been approved by Thermo Scientific are used (third-party spares without Thermo Scientific approval void the limited warranty),
- inspections and maintenance are performed at the specified intervals,
- an operation verification test is performed after each repair activity.

The warranty is valid from the date of delivery of the incubator to the customer.

Explanation of Safety Information and Symbols

Safety Notes and Symbols Used Throughout These Operating Instructions

	 <p>Indicates a hazardous situation which, if not avoided, will result in death or serious injuries.</p>
	 <p>Indicates a hazardous situation which, if not avoided, could result in death or serious injuries.</p>
	 <p>Indicates a situation which, if not avoided, could result in damage to equipment or property.</p>
	 <p>Is used for useful hints and information regarding the application.</p>

Additional Symbols for Safety Information

	Wear safety gloves!
	Wear safety goggles!
	Harmful liquids!
	Electric shock!
	Hot surfaces!
	Fire hazard!
	Explosion hazard!
	Suffocation hazard!
	Biological hazard!
	Contamination hazard!

Symbols on the Incubator



Observe operating instructions



CE-conformity mark: confirms conformity according to EU Guidelines



Mark of conformity USA/Canada



VDE test mark

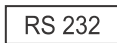

RS 232 interface



Fuse, 2 Ampere slow-blow

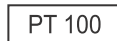

PT100 sensor element

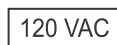

120 Volts AC power socket



Interface port

Intended Purpose of the Incubator

Correct Use

Heratherm incubators are laboratory devices for preparing and cultivating cell and tissue cultures. The devices employ precision temperature control for simulating the specific physiological ambient conditions for these cultures.

Heratherm incubators have been designed for installation and operation in the following environments:

- Laboratories for cytobiological and biotechnological experiments of safety levels L1, L2, and L3.
- Medical-microbiological laboratories in accordance with DIN 58 956.
- Laboratories in the central area of clinics and hospitals.

Incorrect Use

To avoid the risk of explosion do not load the incubator with tissue, material, or liquids that:

- are easily flammable or explosive,
- release vapor or dust that forms combustible or explosive mixtures when exposed to air,
- release poisons,
- do not pour any liquids on the bottom of the interior surface or into a collecting basin inside the unit.
- release dust
- exhibit exothermic reactions
- are pyrotechnical substances

Standards and Directives

The incubator complies with the following standards and guidelines:

- IEC EN 61010 - 1, IEC EN 61010 - 2 - 010
- Low Voltage Directive 2006/95/EC
- EMC Directive 2004/108/EC

Additionally, the incubator is in compliance with many other international standards, regulations and directives not listed here. Should you have any questions regarding compliance with national standards, regulations and directives applicable for your country, please contact your Thermo Fisher Scientific sales organization.

Delivery of the Incubator

Packaging

Heratherm incubators are delivered in a rugged packaging box. All packaging materials can be separated and are reusable:

Packaging materials

Packaging carton: Recycled paper

Foam elements: Styrofoam (CFC-free)

Pallet: Chemically untreated wood

Packaging film: Polyethylene

Packaging ribbons: Polypropylene

Acceptance Inspection

After the incubator has been delivered, check the delivery immediately for:

- completeness,
- possible damage.

If components are missing or damage is found on the incubator or the packaging, in particular damage caused by humidity and/or water, please notify the carrier as well as Thermo Scientific Technical Support immediately.

	 WARNING Risk of injury
	Should sharp edges have formed in damaged areas or elsewhere on the device, take all necessary precautions to protect personnel handling the incubator. For example, have them wear protective gloves and other personal protection equipment.

Scope of Supply

Incubators

Quantity of components supplied (pieces)	IGS Series
Perforated sheet	2
Support rail for shelf	4
Power cord	1
Connector, potential-free contact	1
Operating manual	1
Contact brackets	4
Clip springs	4

Installation



Ambient Conditions

The incubator must only be operated in a location that meets all of the ambient condition requirements listed below:

Location Requirements

- Installation location indoors in dry areas free from drafts.
- Dust loading should be in keeping with the degree of contamination, which is Pollution Degree 2 according to IEC EN 61010-1. Using the incubator in an atmosphere with electrically conductive dust is prohibited.
- The minimal distance to adjacent surfaces must be observed on all sides (see Section “Space Requirements” on page 3-2)
- The operating room must be equipped with appropriate ventilation.
- Solid, level, fire-proof surface and no flammable materials opposite to the rear panel of the oven.
- Vibration-proof substructure (floor stand, lab table) capable of bearing the dead weight of the incubator and its accessories (particularly if two devices are stacked).
- The incubator has been designed for an operating height of up to 2000 m above sea level.
- Temperature range from 5 °C to 40 °C / 41° F to 104° F.
- Relative humidity up to 80% (maximum; preferably 60-70%), non condensing.
- Should condensation exist, wait until the moisture has evaporated completely before connecting the incubator to a power source and powering up.
- To ensure a constant incubation temperature of 37 °C (98.6 °F), the ambient temperature must be within a range of +18 °C to +32 °C (64.4 °F to 89.6 °F).
- Avoid direct exposure to sunlight.
- Devices that produce excessive amounts of heat must not be placed near the incubator.
- Place the incubator on a floor stand (option; to be ordered separately), never on the lab floor.
- Power line voltage variations must not exceed ±10 % of the nominal voltage.

- Transient surges must lie within the range of levels that normally occur in the power supply system. The impulse withstand voltage based on surge category II of IEC 60364-4-443 shall be applied at the nominal voltage level.
- Consider installing one dedicated upstream circuit breaker per incubator to avoid multiple device failures in case of an electrical fault.

	 WARNING	Contamination hazard
<p>Do not place the incubator directly on the lab floor, but mount it on the floor stand or on a lab work surface (option; to be ordered separately). Contaminants, such as bacteria, viruses, fungi, prions, and other biological substances may use the open door to migrate easily from the floor into the incubator's work space.</p>		

Intermediate Storage

When the incubator is placed in intermediate storage, which is permissible for a maximum of four weeks, make sure that the ambient temperature is between 20°C to 60°C (68°F to 140°F) and the maximum relative humidity does not exceed 90%, non-condensing.

Room Ventilation

Heat dissipating from the incubator during continuous operation may cause a change in the room climate.

Therefore, the incubator must only be installed in rooms with sufficient ventilation.

Do not install the incubator in room recesses without ventilation.

When several devices are to be placed in the same room, additional ventilation may have to be provided as necessary.

To avoid any impact of the heat dissipated by the incubator on the ambient climate the room must be vented by means of a laboratory-grade ventilation system that complies with applicable local and national health and safety regulations and has sufficient capacity.

If excessive temperatures tend to occur in the operating room, be sure to provide a thermal protection means that cuts out the power supply to mitigate the impact of overtemperature scenarios.

Space Requirements

When installing the incubator, make sure that the installation and supply connections remain freely accessible.

The specified side clearances represent minimum distances.

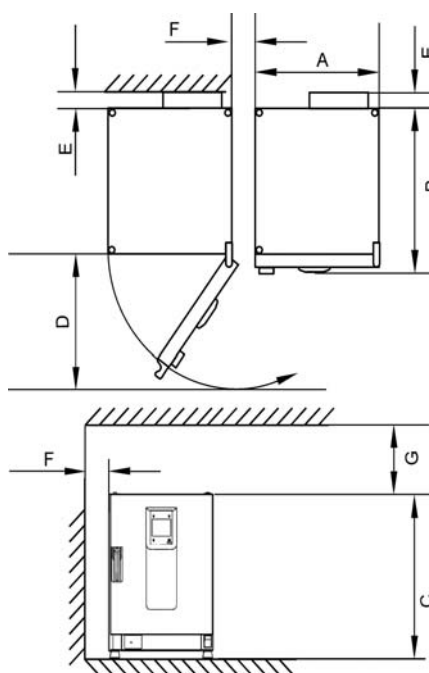

Figure 3-1 Incubator Dimensions and Required Clearances

Table 3-1 Incubator Dimensions

Model	A (mm/inch [*])	B (mm/inch)	C (mm/inch)	D (mm/inch)
IGS 60	530 / 20.8	565 / 25.2	755 / 29.7	540 / 21.3
IGS 100	640 / 25.2	565 / 25.2	855 / 33.7	650 / 25.6
IGS 180	640 / 25.2	738 / 29.1	955 / 37.6	650 / 25.6

*Dimensions in inches are rounded equivalents specified for information only.

Table 3-2 Required Clearances

E (mm/inch)	F (mm/inch)	G (mm/inch)	H (mm/inch)
80 / 3.2	50 / 2	200 / 8	300 / 12

Transport

For transport, do not lift the incubator using the doors or components attached to the incubator as lift points.

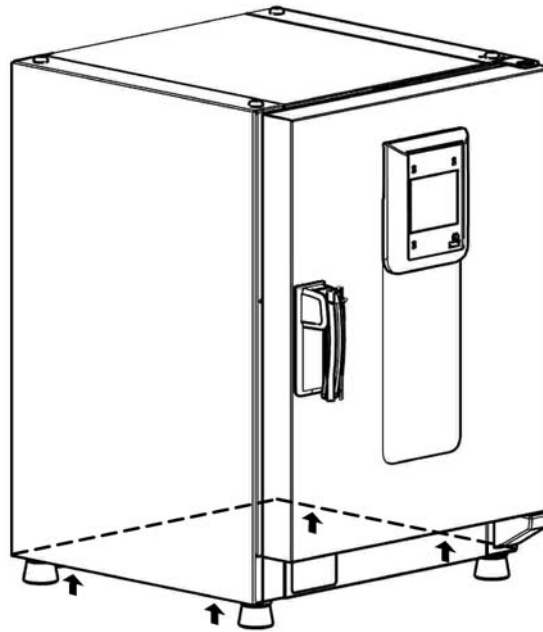

Figure 3-2 Lift Points



Heavy loads! Lift with care!

To avoid injury through physical strain, such as strain traumata and slipped discs, do not attempt to lift the incubator alone!
To avoid injury through dropped loads, be sure to wear Personal Protection Equipment, such as safety shoes, when lifting the incubator.
To avoid crushing your fingers or hands (particularly in a closing door) or damaging the incubator, do not use any other lift points than those indicated in the illustration above.

Stacking

Heratherm devices are suited for single-row stacking, that is, one incubator maximum may be stacked on another Heratherm device with the same type of enclosure and same footprint. Stacking requires a stacking frame (available as an accessory).

This is easily achieved without any need for tools by placing the feet of the top device exactly on the two stacking pads provided on the top panel of the bottom device or by installing a stacking frame between the units.

The devices are secured to each other by their own dead weight and the half dome shaped mating surfaces of the feet and stacking pads.

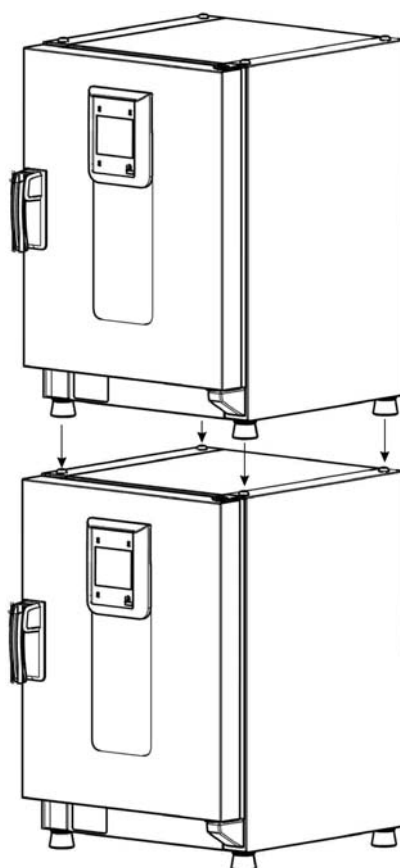

Figure 3-3 Stacking Heratherm Devices

Stacking Instructions



To prevent the top incubator from slipping and dropping down, the following requirements must be fulfilled before devices may be stacked:

- Stack as follows when using a stacking frame:
 - 60/100/180 on 180
 - 60/100 on 100
 - 60 on 60
- Only two units may be stacked together.

- If the two incubators have different surface areas, or if one of the units is a Heratherm oven, a stacking frame (accessory) must be used between the two units.
- the bottom incubator must be correctly levelled;
- the levelling feet on the top incubator must be screwed in all the way;
- the levelling feet of the top device must be aligned with and placed exactly on the stacking pads of the bottom incubator.

	 CAUTION Risk of overheating with stacked devices To avoid the risk of electrical components and the outer enclosure overheating or temperature control failing due to insufficient ventilation, do not exceed the specified stacking height!
--	---

	 CAUTION Risk of tipping and dropping of stacked devices You should be aware at all times that stacked devices do not form a stable unit, even when the stacking pads and feet are correctly used. The top device may tip over and drop down when being transported in a stack. To avoid injury to persons and damage to equipment, do not attempt to move stacked devices as a unit! Separate and move each device one by one, then restack them. Thermo Scientific cannot be held liable for stacking of third-party units; this is done at the user's risk.
--	--

	 NOTE Installation in mobile racks The units can be placed on a mobile roller cart (option to be ordered separately). Make sure that the rollers are secured with locking brakes during the operation of the incubator and that the rollers are oriented toward the outside for increased stability.
	 NOTE Condensation forming while operating stacked devices If stacked devices are operated at an ambient temperature of more than 26 °C (79 °F), temperature control may be adversely affected on the top device while the decontamination routine is running on the bottom device. To prevent any impairment of temperature control, make sure that the space between and around any two stacked devices is well-ventilated for optimum heat removal.

Product Description

This section describes IGS Series Heratherm general protocol microbiological incubators for standard laboratory applications.

Heratherm IGS Series Incubator Overview

IGS Series general protocol microbiological natural convection incubators come equipped with the following features:

- high-precision work space temperature control, adjustable in steps of one-tenth of a degree up to 75 °C (167 °F)
- two perforated sheets

The individual features of IGS Series incubators are shown in [Figure 4-1](#) and [Figure 4-2](#) below.

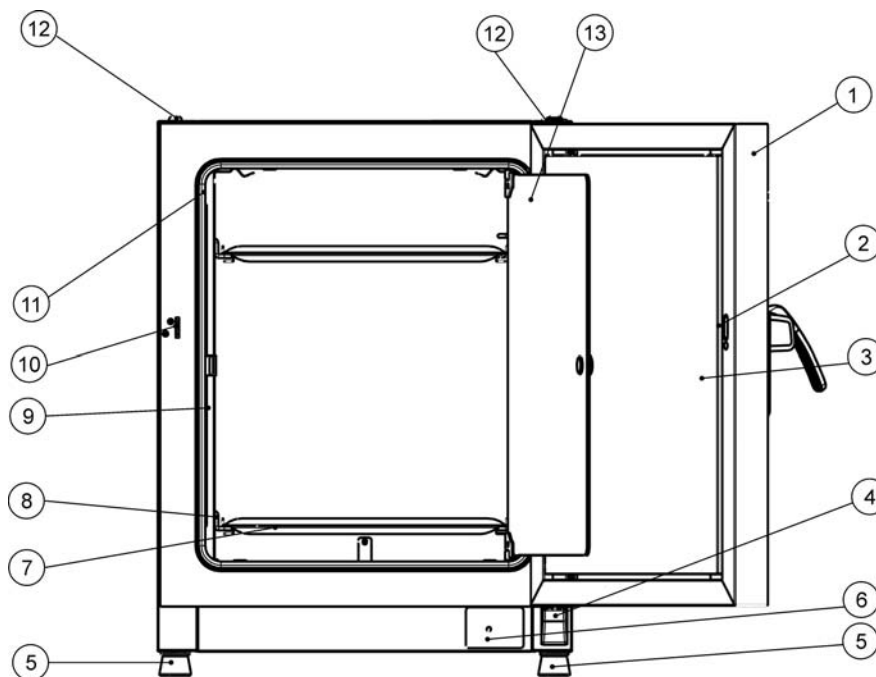

Figure 4-1 Heratherm IGS Front View

- [1] Outer door
- [2] Locked opening
- [3] Door latch and handle
- [4] Door hinge, lower
- [5] Levelling foot

Product Description
Heratherm IGS Series Incubator Overview

- [6] Nameplate
- [7] Perforated-sheet shelf
- [8] Support rail for perforated-sheet shelf
- [9] Shelf rack
- [10] Door hook catch
- [11] Door seal
- [12] Stacking pad
- [13] Glass door
- [14] Temperature sensor

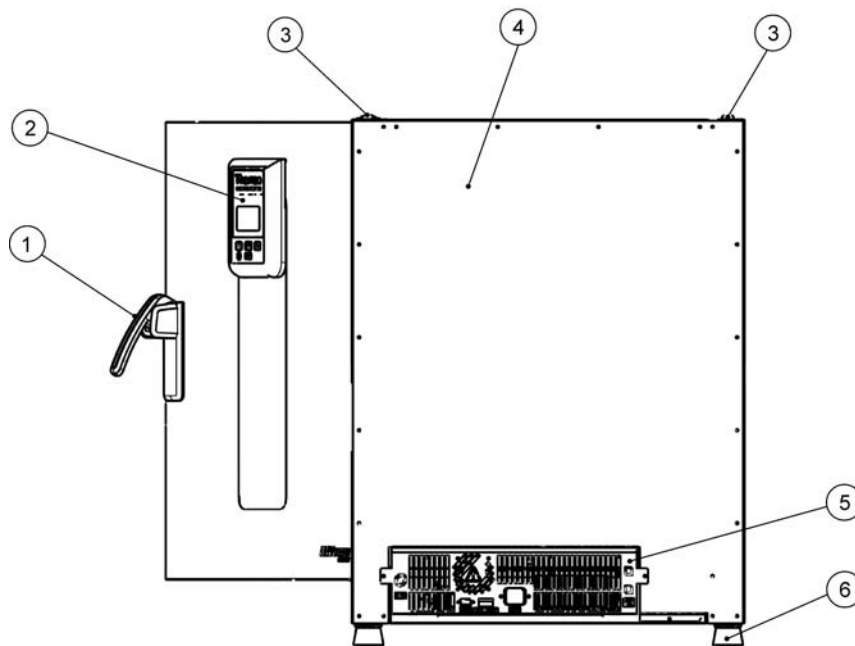

Figure 4-2 Heratherm IGS Rear View

- [1] Door latch and handle
- [2] Control panel
- [3] Stacking pad
- [4] Back panel
- [5] Electronics compartment
- [6] Levelling foot

Safety Devices

The incubators are equipped with the following safety features:

- a sample protection feature that safeguards the samples against destruction through overheating in case of controller failure;
- an overheat protection cut-out feature that shuts down the incubators IMH-S completely when excessive temperatures occur in the workspace;
- dual fuses rated at 16 amperes.

Work Space Atmosphere

To ensure undisturbed operation, the ambient temperature in the operating room must be at least 18 °C (64.4 °F).

The heating system uses this temperature threshold to control the ambient temperature plus 5°C up to the maximum of 75 °C (167 °F) .

Sensing and Control System

The PT 100-type sensor for the control of the work space temperature and for the thermal protection [1] is mounted in the bottom.

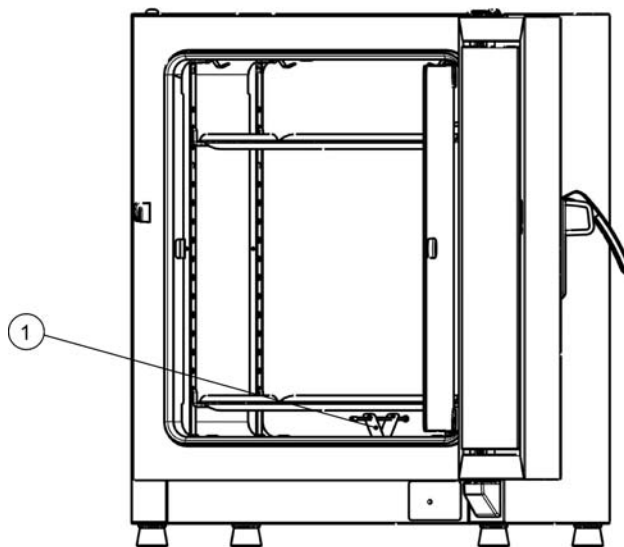

Figure 4-3 Sensor System

The work space temperature sensor provides the inputs to the incubator's built-in controller, which continuously compares the measured values to the user-specified set value and adjusts the heaters according to the result.

The unit features a thermal protection function that is factory-preprogrammed and not adjustable. It protects the cultures in the work space from overheating: Thermal protection kicks in on a brief violation of the upper limit, based on the defined setpoint temperature, at between 2 and 3 °C, automatically reducing the work space temperature to the user-specified set value and allowing the incubation process to be continued even in case of a controller malfunction. If the thermal protection is activated, the error message (E111) “Temperature too high” appears in the display window and an audible alarm is sounded.

When the user acknowledges the error message, the red alarm icon (D3 in [Figure 7-1](#) on [page 7-1](#)) is illuminated and the Temperature Set Value icon (see [Table 7-3](#) on [page 7-3](#)) is highlighted by a red border to indicate that thermal protection has kicked in.

Data Communications & Alarm Interface

All signal connections are installed in the electrical interface panel at the rear of the incubator.

RS-232 Interface

The RS- 232 interface (left in [Figure 4-4](#) below) may be used to connect Heratherm incubators to the serial interface port of a computer to allow for the computer-aided acquisition and documentation of major operating parameters (temperature, error codes, etc.).

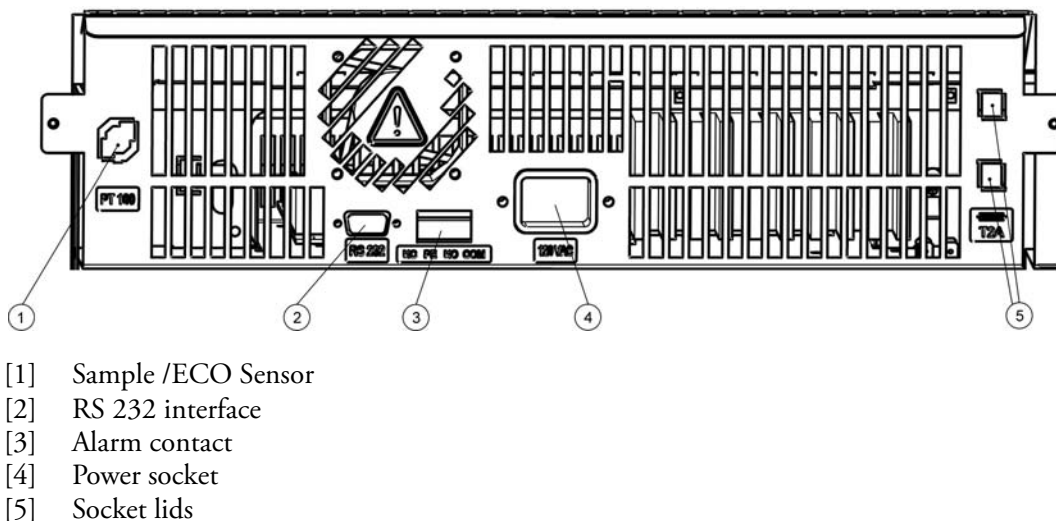

Figure 4-4 Signal Interfaces and Power Socket

Alarm Contact

The incubator can be connected to an on-site, external alarm system (such as a private branch telephone exchange, a facility monitoring system, visual or audible alarm indicators). For this purpose, the devices come with a pre-wired potential-free alarm contact (middle item in [Figure 4-4](#) below). The alarm contact is energized whenever an error occurs in an internal control loop or the incubator’s electrical circuits or hardware.

	<table border="1"><tr><td style="background-color: #0056b3; color: white; padding: 5px; text-align: center;">NOTE</td><td>Alarm contact with IGS Series incubators</td></tr><tr><td colspan="2"><p>Although present with IGS Series incubators, the alarm contact is not part of the feature set of Heratherm general protocol microbiological incubators and hence not functional. If you need remote alarming support for your incubator, please contact your local Thermo Fisher Scientific sales representative.</p></td></tr></table>	NOTE	Alarm contact with IGS Series incubators	<p>Although present with IGS Series incubators, the alarm contact is not part of the feature set of Heratherm general protocol microbiological incubators and hence not functional. If you need remote alarming support for your incubator, please contact your local Thermo Fisher Scientific sales representative.</p>	
NOTE	Alarm contact with IGS Series incubators				
<p>Although present with IGS Series incubators, the alarm contact is not part of the feature set of Heratherm general protocol microbiological incubators and hence not functional. If you need remote alarming support for your incubator, please contact your local Thermo Fisher Scientific sales representative.</p>					

AC Power Socket

The incubator is connected to the AC supply mains via the socket at right in [Figure 4-4](#) above, which accepts a power cord with an IEC standard plug [9].

Fuses

Two 16 A slow-blow fuses mounted on the incubator's main electronic circuit board protect internal circuitry from the impact of excessive power consumption.

	<table border="1"><tr><td style="background-color: #0056b3; color: white; padding: 5px; text-align: center;">NOTE</td><td>Fuse replacement</td></tr><tr><td colspan="2"><p>The device fuses are not user-serviceable. When the incubator exhibits the typical signs of a blown fuse (no response to pressing the On/Off button, control panel remains extinguished, no heating operation), call Thermo Fisher Scientific Customer Service to have the fuses replaced.</p></td></tr></table>	NOTE	Fuse replacement	<p>The device fuses are not user-serviceable. When the incubator exhibits the typical signs of a blown fuse (no response to pressing the On/Off button, control panel remains extinguished, no heating operation), call Thermo Fisher Scientific Customer Service to have the fuses replaced.</p>	
NOTE	Fuse replacement				
<p>The device fuses are not user-serviceable. When the incubator exhibits the typical signs of a blown fuse (no response to pressing the On/Off button, control panel remains extinguished, no heating operation), call Thermo Fisher Scientific Customer Service to have the fuses replaced.</p>					

Work Space Components

Inner Chamber

All components of the work space are made of corrosion-resistant stainless steel and have an absolutely smooth and easy-to-clean surface. Any embossings have a large radius.

Shelf System

The incubator is supplied with two perforated sheets. The shelf support rails [1] have an alternating pattern of oblong and round perforations spaced evenly at 30 mm, allowing the shelf supports [8] to be inserted without any room for error, yet in a very flexible way to accommodate any required height of sample container. The shelves [2] have an integrated tilt protection and pull-out stop. For details on using the shelf system, see [“Start-up”](#) on [page 5-1](#).

Product Description
Work Space Components

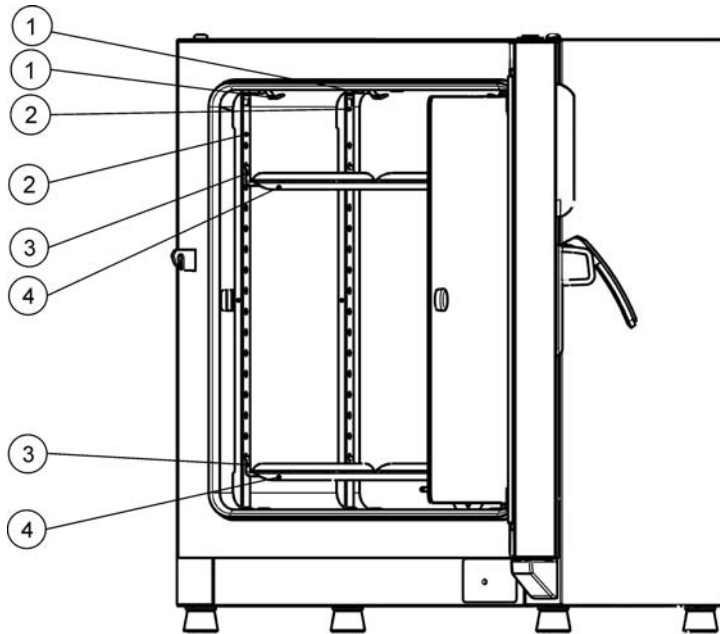

- [1] Retaining Springs
- [2] Support Rails
- [3] Shelf Supports
- [4] Shelves

Figure 4-5 Shelf System

Start-up

Installing the Shelf System

The installation of the shelf system does not require any tools. The support rails are secured in place by spring action. Once the shelf supports have been inserted into the rails, the perforated sheets can be simply pushed onto their support hooks to complete the installation.

Initial installation

1. Peel off the protective foil from the support rails.
2. Push the retaining spring [1] into the guide on the support rail [2], making sure that the locking nub [3] on the retaining spring safely engages with the matching hole in the support rail.

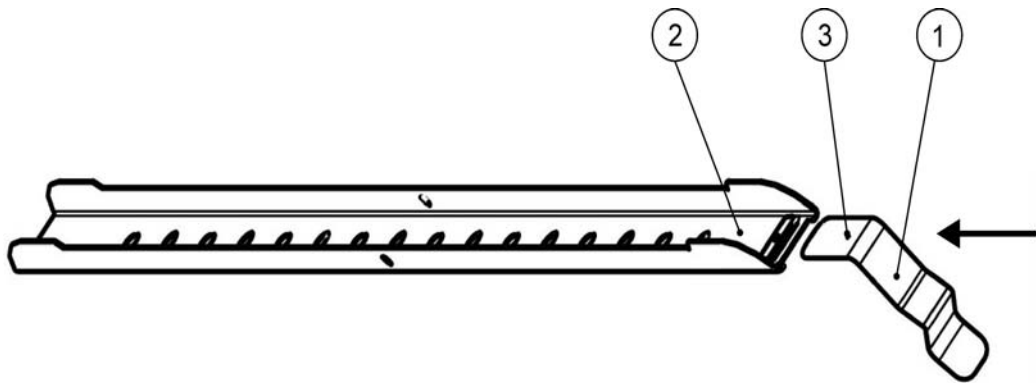
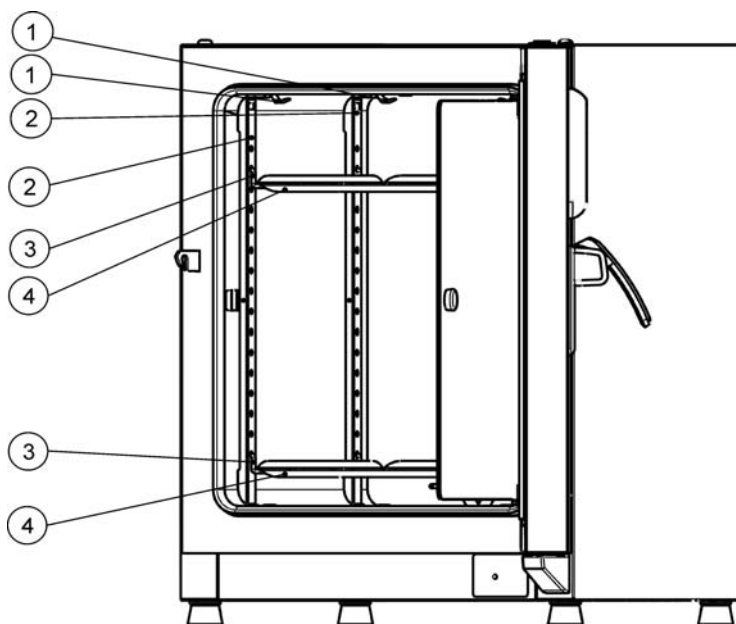

Figure 5-1 Sliding the Retaining Spring into the Support Rail

Installing the Perforated Sheet Shelves

The illustration below shows the placement of the shelf system elements.



- [1] Retaining Springs
- [2] Support Rails
- [3] Shelf Supports
- [4] Shelves

Figure 5-2 Installing the Shelving

Preparing the Work Space

Upon delivery, Heratherm incubators are not in a sterile state. Before the initial start-up, the incubator must be decontaminated.

The following work space components should be checked for cleanliness and disinfected prior to use:

- support rails,
- shelf supports,
- perforated sheets,
- work space surfaces,
- work space seals and gaskets,
- glass door

NOTE

Disinfection

For details about the cleaning and disinfection of the incubator, please refer to “Cleaning” on page 9-1.

Installation or Removal of the Support Rails

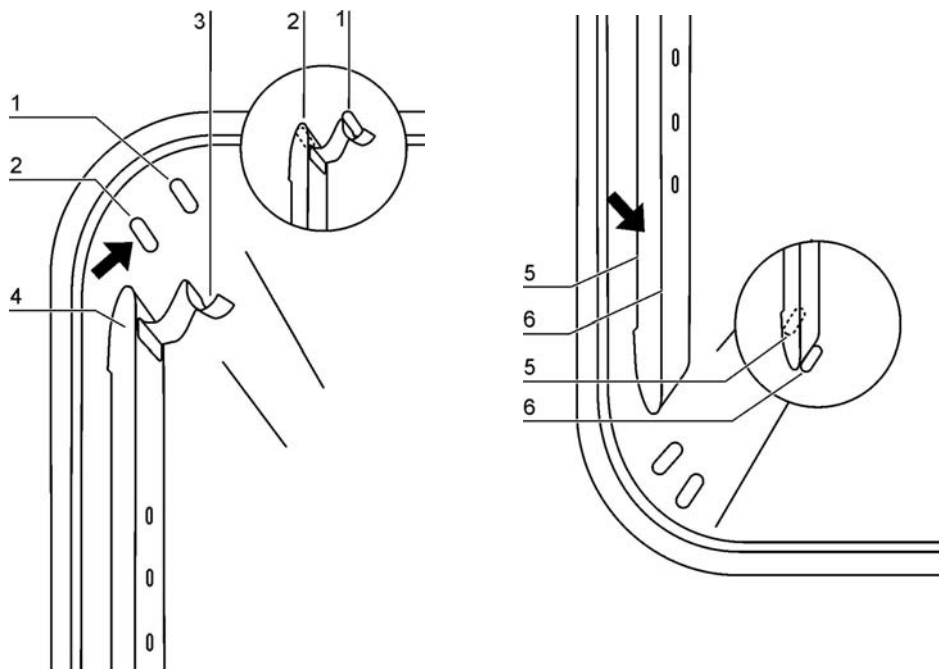

Figure 5-3 Support Rail Installation

The embossings at [2] and [5] act as lateral guides for the support rails, while the embossings at [1] and [6] secure the support rails in place. For the support rails to install correctly the retaining spring [3] must be facing upwards.

1. Place the support rail [4] on the lower embossing [6] and tilt it upwards against the work space side wall so that the rail is positioned over the two embossings at [5] and [2].
2. Clamp the retaining spring [3] behind the upper embossing [1].
3. To remove the support rails, pull the retaining spring tab down out of the embossing and remove the support rail assembly.

Installing the Shelf Supports

1. Insert the shelf support [3] into the perforations [1] of the support rail and air baffle and tilt them downwards.
2. Make sure that the two vertical elements [2] of the shelf support are flush with the support rail and air baffle.

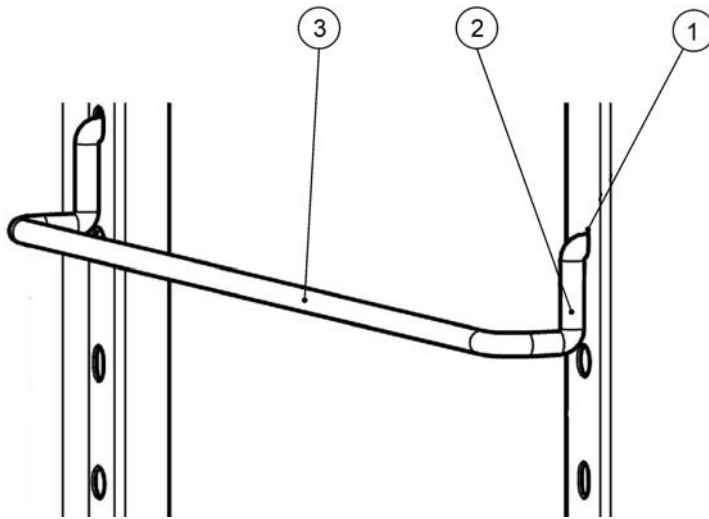
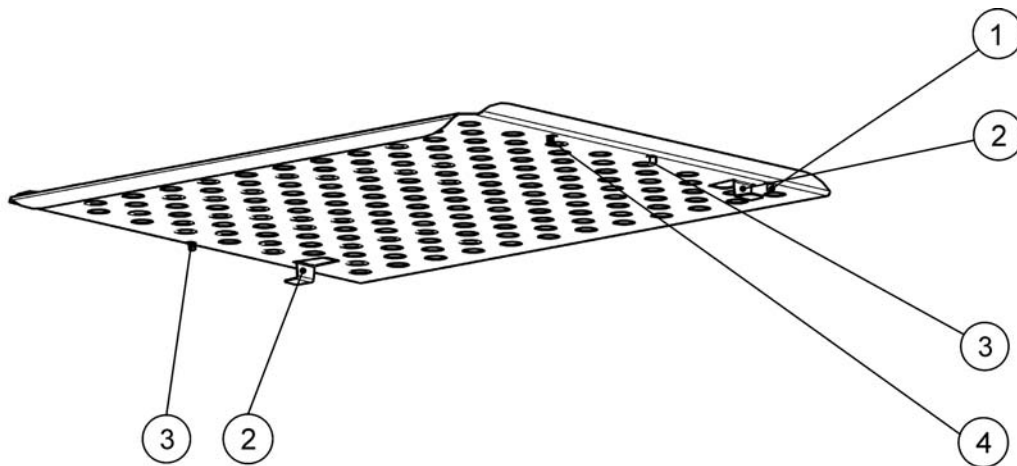

Figure 5-4 Shelf Support Installation

Installing the Perforated Sheet Shelves



- [1] 1 Rear Pull-out Stop
- [2] 2 Tilt Protection Device
- [3] 3 Front Pull-out Stop
- [4] 4 Shelf Guide

Figure 5-5 Perforated Sheet Shelf



1. Push the shelf [4] onto the shelf supports with the tilt protection devices [2] facing the rear panel of the incubator.
2. Slightly raise the perforated sheet shelf so that the pull-out stops [1] and [3] can slide over the shelf supports.
3. Make sure that the shelves and both of their tilt protection devices are free to move over the shelf supports.

Levelling the Incubator

1. Position a bubble level onto the center shelf.

2. Manually adjust the levelling feet until the shelf is horizontally aligned in all directions. Perform the adjustment of the levelling feet from left to right and from rear to front.

Connecting Power

	<div style="display: flex; align-items: center;">  <div style="margin-left: 10px;"> <p>Electric shock</p> <p>Contact with live electrical components may cause a lethal electric shock. Before connecting the incubator to the power supply, check the power cord and the plug for damage. Do not use damaged cables for connecting the incubator to the power supply!</p> </div> </div>
---	---

The incubator has a class I, protection-earthed enclosure. To minimize the risk of electrical shock, use the AC power cord supplied to connect the incubator to a correctly installed and protection-earthed power supply source, with the following features in place for each incubator:

- T 16 A slow-blow fusing
- B 16 circuit breaker

Connecting to the Power Supply Source

1. Before connecting the incubator to the power source, check to see if the power supply voltage corresponds with the specifications on the nameplate on the front of the incubator. If the voltage (V) and current (A) ratings given are not as required, do not connect the incubator to the power source!
2. Connect the IEC connector to the socket at the rear of the incubator.
3. Route the power cord along a path that does not cross exhaust air piping or passageways and aisles.
With stacked devices, keep the power cord away from hot spots on the other incubator in the stack.
4. Connect the protection-earthed plug of the power cord to a correctly protection-earthed and earth leakage circuit breaker fused power socket.
5. Make sure the power cord is not subjected to tensile or compressive force.

	<p>Keep the power outlet accessible!</p> <p>To allow a rapid disconnection of power in case of an emergency, make sure that power outlets remain freely accessible at all times!</p>
---	---

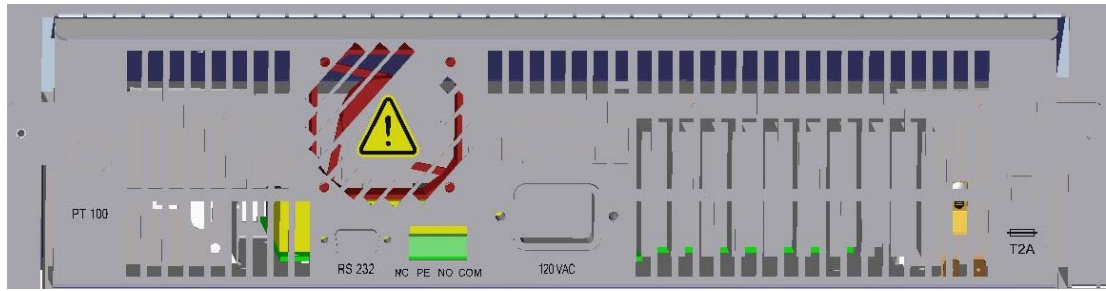



Figure 5-6 AC Power Supply Socket

Note The alarm contact (marked with an asterisk “*” in [Figure 5-6](#) above) is not functional with IGS Series incubators. If you have a need for alarming, please contact Thermo Scientific Customer Support for advice.

		<p>Condensation</p> <p>When taking the incubator into operation for the first time allow some time before switching on for stabilization to avoid condensation forming on live parts.</p>
--	---	--

Connecting the RS-232 Interface

The RS-232 data communication interface supports the querying of status information and temperature data from the incubator by entering basic commands in a standard terminal window provided by your computer’s operating system. The interconnection requires a standard RS-232 cable with 9-pin connectors and a straight “1:1” pinout without any crossed wires, which is not supplied with the incubator.

Users may employ the RS-232 command inventory listed in [Table 5-1](#) below for automating process data logging - for example, by embedding these commands in scripts that run on a remote computer.

		<p>RS-232 interface compatibility</p> <p>To avoid overloading and damaging the RS-232 interface check the interfacing parameters against the pin-out description given above and make sure that computer’s interface port works with a signal level of +/- 5V DC.</p>
--	---	--

Interconnecting the Incubator with a Computer

1. Turn the computer off.
2. Route the serial interface cable along a path that does not cross hot exhaust air piping, tables, aisles or passageways.

With stacked devices, keep the serial interface cable away from hot spots on the other incubator in the stack.

3. Connect one connector of the serial interface cable (cable length, 5 to max. 10 m, not supplied as a standard item) to the socket labeled **RS 223** in the computer and alarm interface section at the rear of the incubator (see “[Signal Interfaces and Power Socket](#)” on [page 4-4](#)).
4. Connect the second connector to an unused COM 1 /COM 2 or other serial port on the computer.
5. Boot the computer.
6. Launch your standard terminal program and set up the connection with the following parameters:
 - 9600 bits per second
 - 8 data bits
 - 1 stop bit
 - No Parity
7. Once your terminal indicates that serial communication has been established successfully, enter any of the commands listed in [Table 5-1](#) below, depending on what type of information you want to query.
8. Use the following generic command syntax:

?:aaa:00:Cn , where:

- **?:** identifies the command line as a query;
- **aaa:** is the parameter address;
- **:Cn** specifies the type of data to be queried (see the examples in [Table 5-1](#) for reference)
- **:00** is a response field (retained in the query for technical reasons) that must be left at “00”;
- **<CR>** is for carriage return.

You will receive a response of the following general format:

!:aaa:bb:XXXXX:cc<CR> , where:

- **!:** identifies the line as a response to a query;
- **aaa:** is the parameter address entered with the query;
- **bb:** is the number of payload bytes in hexadecimal code— for example, **1F** for the decimal value **31**;
- **XXXXXX:** is the significant status information queried;
- **cc:** is a check sum (technically an inverted XOR of all bytes returned, excluding the check sum bytes and the **<CR>** character);
- **<CR>** is for carriage return.

Table 5-1 Terminal Commands for Querying Data

Command Syntax	Response Example
Combined Date and Time	
?:0010:00::c1	!:0010:11: 31.07.10 ; 01:02:23 :e2 Date Time
Date only	
?:0011:00::c0	!:0011:08: 31.07.10 :d2 Date
Time only	
?:0012:00::c3	!:0012:08: 01:02:23 :dc Time
Temperature Set Value (T1); Current Work Space Temperature (T2); Reference Temperature (T3); Sample Sensor Temperature (T4)	
?:3010:00::c2	!:3010:1f:+125.00;+124.96;+000.000;+000.00:b0 T1 T2 T3 T4

Operation

Preparing the Incubator

The incubator must not be released for operation before all major start-up activities have been completed (see [Chapter 5, “Start-up.”](#)).

Device Check

Prior to starting operation, the following incubator components must be checked for their correct function:

- The door seal in the front frame must not be damaged.
- The glass door must not be damaged.
- The shelving components must be installed safely.
- Disinfecting the Incubator’s Work Space

Starting Operation

1. Turn the incubator on using the control panel.
2. Adjust the temperature set value on the control panel.
3. The temperature controller starts adjusting the work space to the user-specified temperature set value now.



DANGER

To avoid any risk of explosion or fire

- refrain from loading the incubator with any of the substances listed in the section **“Incorrect Use”** on [page 1-6](#)
- make sure that the ambient air is free of any solvents
- do not operate the incubator in areas with an explosion hazard

4. Load the work space with samples.



 **WARNING**

Hot surfaces

The screen of the glass door, the interior panel of the outer door as well as the surfaces of the shelving and the work space become extremely hot while the incubator is running through its heating cycles and need some time to cool down.

When removing samples from a running or recently completed heating cycle, always wear safety gloves and other appropriate personal protection equipment to avoid burns on hot surfaces!

 **CAUTION**

Risk of overloading

Overloading may damage the shelves or cause the shelves and/or the incubator to tilt when the shelves are being drawn out, ultimately destroying the samples. To avoid overloading the incubator or its shelving be sure to observe the sample weight limits specified in [Chapter 13, "Technical Data."](#)

NOTE

Proper loading

To ensure sufficient air circulation and uniform heating of the samples, do not use more than 70% of the maximum surface area of the work space. Bulky objects in the work space that dissipate heat may impair heat distribution.

Handling and Control

Heratherm IGS Series incubators come with a front panel mounted control unit consisting of a multifunctional display, four control buttons, and an on/off button. The four control buttons interact with the display window to let users access all of the user control functions and adjustments of the incubator, including - for example, the temperature set value, timer, energizing/de-energizing the AC outlet in the work space, as well as a variety of other functions.

Under normal operating conditions the display presents user with the work space temperature. The display returns to its default mode upon completion of the adjustments or whenever no entries have been made for a period of 30 seconds.



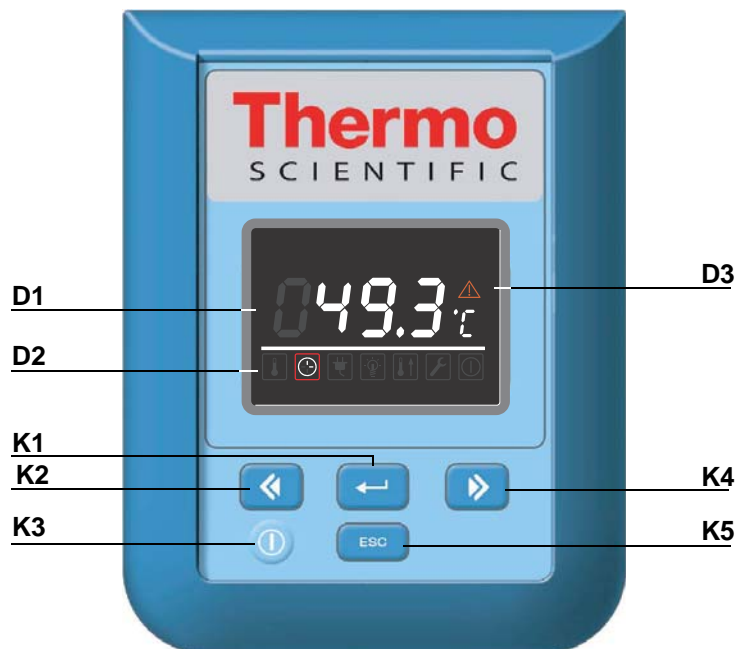

The graphic below shows the Heratherm IGS 60/100/180 control panel with all of its visualization elements and controls.

Figure 7-1 Control Panel for Heratherm IGS Series Incubators







The table below contains brief descriptions of the buttons on the control panel (items K1 through K5 in [Figure 7-1](#)).

Table 7-1 Control Buttons

Icon	Item	Function
	K1	<p>Menu/Enter button</p> <p>First key press: Activates the menu, highlighting the first menu item with a red border (see D2).</p> <p>Second key press: Selects the currently activated menu item (as highlighted by the red border). At the same time, pressing this button enables entries with item D1.</p> <p>Third key press (once a setting has been changed): Confirms a previous entry or selection.</p>
	K2	<p>Left button</p> <p>After the first press of the Menu/Enter button:</p> <ul style="list-style-type: none"> - Moves the selection in the menu (see item D2) to the next icon on the left. <p>Once a menu item has been selected:</p> <ul style="list-style-type: none"> - Decreases an adjustable parameter value - for example, the temperature set value in D1 . Holding this button depressed for a few seconds changes the selected value in quick run mode. - Moves the selection in the display field D1 in the currently activated menu item to the next option on the left - for example, from the Off state of the timer to On.
	K3	<p>On/Off Button</p> <p>Holding this button depressed for 2 seconds switches the incubator off. The display window goes out, except for the readiness indicator icon in the status display area at item D3.</p> <p>The temperature display field D1 provides a dimmed readout of the work space temperature, provided that the temperature exceeds 50 °C (122 °F).</p>
	K4	<p>Right button</p> <p>After the first press of Menu/Enter button:</p> <ul style="list-style-type: none"> - Moves the selection in the menu (see item D2) to the next icon on the right. <p>Once a menu item has been selected:</p> <ul style="list-style-type: none"> - Increases an adjustable parameter value - for example, the temperature set value in D1. Holding this button depressed for a few seconds changes the selected value in quick run mode. - Moves the selection in the display pane in D1 in the currently activated menu item to the next option on the left - for example, from the Off state of the timer to On.
	K5	<p>Escape button</p> <p>Returns to the previous level of the menu or standard display. Upon exiting from the current menu item the user may be prompted to save any previously made settings.</p>

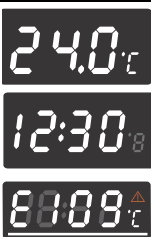
The table below contains brief descriptions of the display features of the control panel (items D1 through D3 in [Figure 7-1](#); the identifiers K1 through K4 refer to the buttons shown in that figure).

Table 7-2 Display Features

Feature	Item	Function
	D1	<p>Display field showing a permanent readout of the actual temperature in the work space either in °C or °F (depending on the user's preferences, see “Toggling the Temperature Display Unit” on page 7-12). At temperatures below 105 °C or 221 °F the temperature readout has one digit after the decimal point, while temperatures beyond are shown without any decimal places.</p> <p>A flashing time entry prompt of the general format hh:mm (hours:minutes, both with two digits) appears in this place while the user is setting up a timer.</p> <p>Upon occurrence of an error condition, the current error code flashes in this area, along with the red alarm icon at D3.</p>
	D2	<p>Menu bar with iconized representations of adjustable parameters. A red border is used to highlight the current menu item, as selected using the Menu (K1) and arrow buttons Left (K2) and Right (K4). Brief descriptions of the individual menu items are given in Table 7-3 below.</p> <p>Note If a menu item cannot be selected, then the function it represents is not part of the equipment configuration of your unit.</p>
	D3	<p>Alarm icon: Upon occurrence of an error condition, the red alarm icon will be illuminated. At the same time the current error code will flash in the temperature display field D1. The alarm may be acknowledged by pressing the  button.</p>

The table below contains brief descriptions of the menu bar icons (item D2 in [Figure 7-1](#)).

Table 7-3 Menu Bar Icons





Icon	Function
	<p>Temperature Set Value</p> <p>Allows for changing the temperature set value (factory-preset to 37 °C/99 °F) within the permissible temperature range. The set value can be changed by pressing the Left and Right (item K2 or K4) and you can, after confirming your changes with the Menu/Enter button (item K1), track the impact on the actual temperature in the display field at D1.</p> <p>Instructions: “Temperature Set Value” on page 7-6.</p>
	<p>Timer</p> <p>Allows for having the incubator turn on and/or off upon expiry of a user-specified countdown period. When the user enables an “on timer” the display goes out. A rotating hand in the Timer icon and the illuminated readiness indicator icon in the status display area indicates that the timer is running.</p> <p>Instructions: “Timer” on page 7-7.</p>

Table 7-3 Menu Bar Icons

Icon	Function
	<p>Settings</p> <p>Invokes a submenu with the following functions:</p> <ul style="list-style-type: none"> - Read access to error log - Calibrating the incubator - Toggling the temperature display unit between °C and °F - Entering a configuration control code <p>(Instructions: “Settings” on page 7-10)</p>
	<p>Readiness Indicator</p> <p>Illuminated when the incubator has been switched off using the On/Off button (item K3 in Figure 7-1). Unlike other menu items, this icon cannot be selected.</p> <p>(Instructions: “Switching the Incubator Off / Powering Down” on page 7-5)</p>

Powering Up

1. Plug the power plug of the incubator into a suitable protection-earthed AC power outlet.



In the display window on the front panel the readiness indicator icon (rightmost icon in the menu bar at D2 in [Figure 7-1](#) on [page 7-1](#)) is illuminated.



2. Keep the **On/Off** button depressed for two seconds.

An initialization routine will be run after the has been powered up. On completion of the initialization, the display will light up and the current work space temperature will appear in the temperature display field (item D1 in [Figure 7-1](#) on [page 7-1](#)). The incubator is ready for use now.

Switching the Incubator Off / Powering Down



1. Keep the **On/Off** button depressed for two seconds.

The display window goes out, except for the readiness indicator icon (rightmost icon in the menu bar at D2 in [Figure 7-1](#) on [page 7-1](#)) and a residual heat temperature readout in case the work space temperature is still higher than 50 °C (122 °F). The incubator is switched off now.



2. If required, unplug the AC power plug to power down the incubator completely.

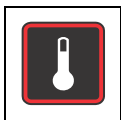

Temperature Set Value

Heratherm incubators allow for setting the desired work space temperature directly using only a few button presses. After confirming the new temperature set value, you may trace the resulting temperature change in the temperature display field (item D1 in [Figure 7-1](#) on [page 7-1](#)).

Table 7-4 Adjusting the Temperature Set Value

	<p>Press to activate the menu bar, then use to select the Temperature icon and press to confirm.</p>
	<p>In the temperature display pane, press or to adjust a new temperature set value, then press to confirm your settings.</p>
	<p>The display returns to its default mode. The actual temperature measured in the work space and shown in the temperature display area starts to change until it reaches the newly adjusted set value.</p>



Timer













The **Timer** feature from the menu bar enables the user to set a “countdown-type” on or off timer that switches the incubator on or off after a preset period of time. Instructions for setting an off timer are given in [Table 7-5](#) (see below), while the usage of an on timer is described in [Table 7-6](#) on [page 7-8](#).

Programming a turn-on time causes the incubator to switch off until it is scheduled to restart, while a turn-off time keeps the device running before it shuts down at the user-specified time. The timer starts running immediately as soon as the user confirms his or her entries.

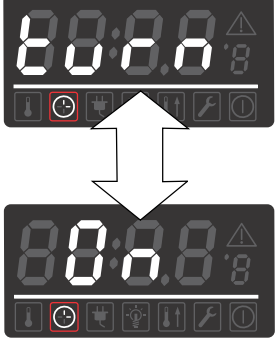
Table 7-5 Setting a Countdown-type Off Timer

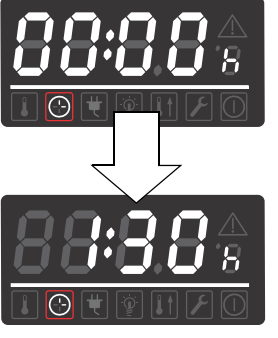
	<p>Press to activate the menu bar, then use to select the Timer icon and press to confirm.</p>
	<p>The words Shut and OFF are flashing alternately in the multifunctional display pane.</p> <p>Choose the off timer with .</p>
	<p>Set the hours and minutes until the incubator is supposed to shut down by pressing or , then press to confirm.</p>
	<p>The display returns to its default mode.</p> <p>In the menu bar, the Timer icon is illuminated and a hand is rotating on the icon's face.</p>

Table 7-6 Setting a Countdown-type On Timer

	<p>Press  to activate the menu bar, then use  to select the Timer icon and press  to confirm.</p>
	<p>Press  to select the on timer option On, then  to confirm.</p>
	<p>The words turn and On are flashing alternately in the multifunctional display pane.</p> <p>Press  to select the on timer option and confirm the selection with .</p>
	<p>Set the hours and minutes until the incubator is supposed to turn on by pressing  or , then press  to confirm.</p>
	<p>The incubator switches off.</p> <p>The display goes out, the Timer icon is illuminated in the menu bar with a rotating hand on its face. Additionally, the readiness indicator icon is illuminated.</p>

Stopping a Timer

Table 7-7 Stopping an Off Timer Before It Expires





	<p>Press  to activate the menu bar, then use  to select the Timer icon and press  to confirm.</p>
---	--

Table 7-7 Stopping an Off Timer Before It Expires







	<p>Confirm the OFF message by pressing , then press  to return to the main menu.</p>
	<p>In the menu bar, the Timer icon  will go out.</p>

Table 7-8 Stopping an On Timer

	<p>To cancel a pre-programmed on timer while the incubator is switched off, hold the On/Off button depressed for a few seconds.</p>
	<p>In the menu bar, the Timer icon will go out.</p>



Settings

The **Settings** menu item opens a submenu populated with various commands for viewing general status information on the Heratherm unit and setting for the operation of the incubator or its display window:

- Read access to error log
- Calibrating the incubator
- Toggling the temperature display unit between °C and °F
- Entering a configuration control code

Instructions for using these features are given in the following.

Error Log





Users calling customer service for support may be asked by the Thermo Fisher Scientific agent to supply information from the error log of the incubator. It enables the user to browse through the most recent 22 alarm messages that were caused by hardware or control loop errors. Each error is displayed with an internal error code.

Error codes and instructions for clearing alarm conditions appear in the section “[Error Codes](#)” on [page 12-1](#).

Table 7-9 Reading the Error Log

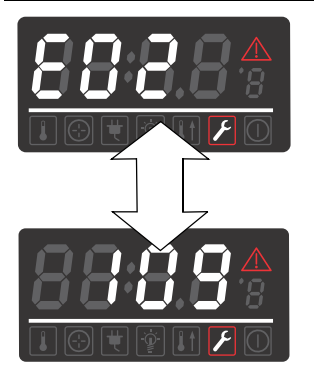
	<p>Press to activate the menu bar, then use or to select the Settings icon and press to confirm.</p>
	<p>The word Err appears in the display pane to indicate that the error log has been selected.</p>
	<p>Use the button to select the first entry in the error log, numbered E01 (Error 01). After a few seconds, the display pane automatically switches to the internal error code - for example, 109. E01 shows the latest fault, E22 shows the oldest fault.</p>

Table 7-9 Reading the Error Log

	<p>Press  to go to the next entry (or  to go back to the previous one).</p> <p>After reaching the entry numbered 22 the display wraps and returns to the beginning of the error log, displaying E01 again.</p>
	<p>To exit from the error log and return to normal display mode press  twice.</p> <p>The Settings icon in the menu bar will go out.</p>















Calibration

The **Settings** -> **Calibration** menu item enables the user to initiate a temperature calibration process (see “[Temperature Calibration Procedure](#)” on [page 10-3](#)) for the built-in temperature sensors and choose whether calibration should be accomplished manually or automatically:

- The **Manual** option allows for entering an absolute temperature directly, as measured—for example, using an external reference sensor.
- The **Sample** option allows for calibrating the incubator’s temperature control by directly entering the absolute temperature obtained from an external sample sensor (option to be ordered separately) and reference measuring device.

	<div style="border: 1px solid black; padding: 5px; margin-bottom: 10px;"> <p style="text-align: center;">NOTE</p> </div> <p style="text-align: center;">Calibration Prerequisites</p> <p>Maintain the ambient conditions within the specified limits of the incubator before launching calibration.</p> <p>Varying ambient conditions may impact the result of the calibration routine, which may lead to misadjustment of the controller and unreliable temperature control operation.</p>
--	---

Table 7-10 Entering the Calibration Reference Temperature Manually

	<p>Press  to activate the menu bar, then use  or  to select the Settings icon and press  to confirm.</p>
 	<p>Press  to switch to the CAL(ibration) menu item. Press  to confirm the selection.</p> <p>The option USEr now appears in the display. Press  to confirm the selection.</p>
	<p>In the settings dialog that appears, set the temperature measured with the external reference sensor by using  or  and confirm your settings with .</p>
	<p>The newly entered value will be stored and used to calibrate the internal temperature sensors with the value measured by the reference sensor. The display returns to its default mode. The Settings icon in the menu bar will go out.</p>

Temperature Display Unit

The **Settings -> °C / °F** menu item allows for toggling the incubator used for displaying temperatures between degrees Centigrade and Fahrenheit.

Note This setting does not have any impact on data logging via the RS-232 interface. Any temperature data that is logged to a computer for operational parameter documentation purposes is handed over in °C.

Table 7-11 Toggling the Temperature Display Unit













	<p>Press  to activate the menu bar, then use  or  to select the Settings icon and press  to confirm.</p>
	<p>Press  to switch to the C - F menu item. The text C - F is flashing in the display pane.</p>

Table 7-11 Toggling the Temperature Display Unit

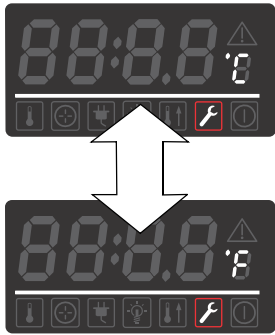

	<p>Press the  button.</p> <p>The currently selected temperature unit °C or °F is flashing in the display pane (factory setting is °C).</p> <p>Press  or  to switch to the desired temperature unit and confirm the selection with .</p>
	<p>The temperature unit to the right of the temperature display field (item D1 in Figure 7-1 on page 7-1) has changed according to your selection.</p> <p>The display returns to its default mode.</p> <p>The Settings icon in the menu bar will go out.</p>

**Handling and Control
Settings**

Shut-down

Shutting the Incubator Down

This chapter provides instructions for shutting the incubator down for prolonged periods of time, that is, at least for several days in a row.



	 WARNING	Contamination hazard
If the work space surfaces are contaminated, harmful biological material may spread to the environment of the incubator.		
To rule out any risk for subsequent users, perform a full cleaning, disinfection and decontamination cycle to the standards set out in the section “Cleaning and Disinfection” on page 9-1 if you suspect (or if you are positive) that harmful biological material has been processed with the incubator.		

1. Remove the containers with the cultures, all accessories, and other objects from the work space.
2. Clean and disinfect the work space, as explained in the section “Cleaning and Disinfection” on page 9-1
3. When cleaning and disinfection and/or decontamination are done, turn the incubator off using the control panel.
4. Unplug the power cord and secure it against accidental reconnection.
5. Until the incubator is shut down, the work space must be continuously ventilated. Leave the glass door and the outer door open and secure them against accidental closure.

**Shut-down
Shutting the Incubator Down**

Cleaning and Disinfection

Cleaning

		Incompatible cleaners
		<p>Some incubator components are made of plastics. Solvents may attack plastics. Strong acids or alkaline solutions may cause embrittlement of plastics.</p>
		Moisture-sensitive components
		<p>Do not spray cleaning agent onto the control panel and the interfaces at the rear of the incubator. When wiping the incubator clean, always make sure that no moisture enters into these components.</p> <p>Wipe the display window down with a slightly dampened cloth, then wipe dry with a rag made of 100% microfiber.</p>

Cleaning Exterior Surfaces

Remove dirt residues and depositions thoroughly using a solution of lukewarm water and commercial detergent.



Wipe the surfaces clean using a clean cloth and clear water.

Then, wipe the surfaces dry using a clean cloth.





Wipe / Spray Disinfection

The manual wipe and spray disinfection is a three-stage process:

- predisinfection,
- cleaning,
- final disinfection.

		Alcoholic disinfectants!
		Disinfectants having an alcohol content of more than 10% may form, in combination with air, easily combustible and explosive gas mixtures.
		When using such disinfectants, avoid open flames or exposure to excessive heat during the entire disinfection process!
		Use such disinfectants only in adequately ventilated rooms.
		After the disinfectant has been allowed to react, wipe the cleaned incubator components thoroughly dry.
		Observe safety regulations to avoid fire and/or explosion hazard caused by alcohol-containing disinfectants.
		Chloride-containing disinfectants!
		Chloride-containing disinfectants can corrode stainless steel.
		Use only disinfectants that do not affect stainless steel!

Preparing the Manual Wipe/Spray Disinfection

		Health hazard
		The surfaces of the work space may be contaminated. Contact with contaminated cleaning liquids may cause infections. Disinfectants may contain harmful substances.
		When cleaning and disinfecting, always observe the safety instructions and hygiene guidelines!
		<ul style="list-style-type: none">• Wear safety gloves.• Wear safety goggles.• Wear mouth and respiratory system protection gear to protect your mucous membranes.• Observe the safety instructions of the disinfectant's manufacturer and the hygiene supervisor.

Predisinfection

1. Remove all samples from the work space and store them in a safe place.
2. Spray disinfectant onto the surfaces of the work space and of the accessories or wipe the surfaces clean using disinfectant.

	 CAUTION Risk of injury caused by breaking of glass panel The glass panel may only be removed by properly trained and authorized specialists. The glass panel must be held by two persons.
--	---

3. Allow time for the disinfectant to act as specified by the manufacturer.



	 NOTE Disinfecting hard-to-reach components Spray the sensor and other hard-to-reach components with disinfectant!
--	--

Cleaning

1. Remove all internals from the specimen chamber.
2. Wipe off the specimen chamber surfaces and the internals that have been removed from the chamber using lukewarm water mixed with standard rinsing agents. Completely remove any tenacious impurities using rinsing agent and warm water.
3. Re-rinse the cleansed surfaces 3 to 5 times with autoclaved water to completely remove and cleaning agent residues.
4. After this, wipe the cleansed surfaces and internals dry with a soft, sterile cloth.

Final Disinfection

1. Spray the specimen chamber surfaces and the internals removed from this chamber again with disinfectant, or wipe them down.
2. Let the disinfectant work on the surfaces/internals as detailed in the manufacturer's instructions.
3. Re-install the internals in the specimen chamber.

	<p>NOTE</p> <p>Recommendations for decontamination</p> <p>The user should be familiar with the internationally recognized “Laboratory Biosafety Manual” (from the World Health Organization (WHO)) and with national, pertinent recommendations. These manuals/recommendations provide information about decontaminants, their use, dilution, properties and possible applications.</p>
	<p> DANGER</p> <p>Bio-hazard</p> <p>Be sure to determine the current operating condition of the incubator before you open the door!</p> <p>Under specific circumstances, there is a risk that bacteria, viruses, fungi, prions, and other biological substances survive</p> <p>Decontamination must be performed immediately if any biohazardous material is spilled in or on the incubator.</p>

Maintenance

Maintenance and inspection at regular intervals of the features and components listed below are mission-critical to maintain the product in a fully operative and safe condition and avoid malfunctions due to ageing and wear. Failure to perform maintenance on a regular basis may result in:

- deviations in heating performance
- damage to samples
- loss of control over temperature distribution throughout the work space

Inspections and Checks

To ensure the operational performance and safety of the incubator and its functions, the components listed below must be checked at regular intervals.

Regular Checks

- Check the incubator for overall cleanliness and remove any residues from previous processes.
- Check the locking screw for the glass panel

Semi-annual Inspection

- Check integrity and proper seating of the seal.
- Perform functional check of the control panel and of the incubator's built-in controller.
- Perform electrical safety check in accordance with the relevant national regulations.

NOTE

Functional Check

If safety devices were removed or disabled for inspections, the incubator must not be operated before the safety devices have been reinstalled and checked for their correct function.

	<div style="border: 1px solid black; padding: 5px;"><div style="display: flex; align-items: center;"><div style="margin-left: 5px;">WARNING</div></div><p style="margin-top: 5px;">Spare Parts and User Modifications</p><p>To avoid major malfunctions of the incubator and associated safety hazards that may result in death, serious injuries, or damage to the incubator and other equipment, use spare parts approved by Thermo Scientific only. Third-party spares without Thermo Scientific approval void the limited warranty.</p><p>Do not modify the incubator in any way without obtaining the prior written authorization from Thermo Scientific. Unauthorized modifications may compromise operational safety and give rise to hazards that may result in death, serious injuries, or damage to the incubator and other equipment.</p></div>
--	---

Service Intervals

During running operation, the following service works must be performed:

3-monthly service

- Perform the comparative temperature measurement outlined in the following section.

Annual Service

- Have the incubator inspected and services by a Thermo Scientific authorized Technical Service agent.

	<div style="border: 1px solid black; padding: 5px;"><div style="display: flex; align-items: center;"><div style="background-color: #0070C0; color: white; padding: 5px; font-weight: bold; font-size: 1.2em; margin-right: 10px;">NOTE</div><div>Service contract</div></div><p>Thermo Electron LED GmbH offer a product-specific service contract comprising all necessary tests and service work.</p></div>
--	--

Preparing Temperature Calibration

To determine the exact measured value of the incubator's integral temperature sensor, a temperature comparison measurement must be performed every three months. If a major temperature deviation is found during this check, temperature calibration is required. During this process, the temperature controller of the incubator is set to the value measured during the temperature comparison measurement.

Use a calibrated measuring instrument with an accuracy of $< \pm 0,1 \text{ }^\circ\text{C}$ for this test.

To minimize temperature variations during the measurement, put the measuring sensor in an isothermal container (such as a bowl filled with glycerol) before placing it in the work space. Use the center of the work space as the reference location for the comparison measurement.

	<p data-bbox="536 360 895 450">NOTE</p> <p data-bbox="922 387 1214 416">Isothermal container</p> <p data-bbox="520 477 1390 577">Do not use a container filled with water as an isothermal container because the evaporation of water will result in a lower temperature reading.</p> <p data-bbox="536 629 895 719">NOTE</p> <p data-bbox="922 651 1433 680">Excessive work space temperatures</p> <p data-bbox="520 741 1358 804">Excessive work space temperatures after the calibration may be reduced by leaving the doors open for approx. 30 seconds.</p>
--	--

Comparison Measurement Procedure

1. Turn the incubator on using the power switch.
2. Set the temperature set value and allow the incubator to stabilize. This may take several hours.
3. Place the measuring device in the center area of the work space. Alternatively, a temperature sensor may be positioned in this location. Route the connecting cable between the glass panel and the interior tank.
4. Close the doors.
5. Wait until the temperature value displayed on the measuring instrument has stabilized.
6. Use the temperature reading from the measuring device to calibrate temperature control manually, as explained “[Entering the Calibration Reference Temperature Manually](#)” on [page 7-12](#).

Temperature Calibration Procedure

For detailed instructions on how to perform a manual temperature calibration, please refer to the instructions in the section “[Calibration](#)” on [page 7-11](#).

	<p data-bbox="536 1715 895 1805">NOTE</p> <p data-bbox="922 1742 1417 1771">Excessive work space temperature</p> <p data-bbox="520 1843 1433 1906">Excessive work space temperatures after the calibration can be reduced by leaving the doors open for approx. 30 seconds.</p>
--	---

Replacing the Door Seal

The door seal of the outer door is located in the retaining slot.

The door seal should be inspected for any signs embrittlement at half-yearly intervals.

No tools are required to replace the seal.

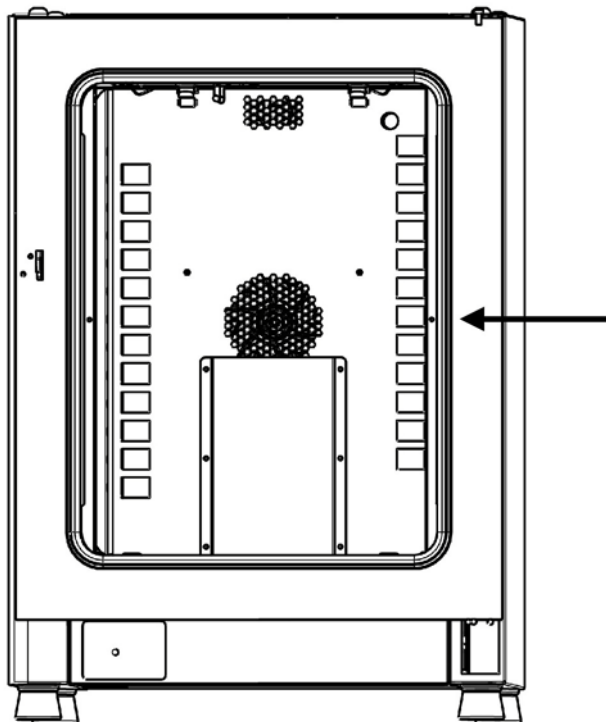

Figure 10-1 Door Seal Replacement

1. Pull the seal out of the guide slot.
2. Starting on the hinge side of the door, position the end of the new seal at the location indicated by the arrow in [Figure 10-1](#) above.
3. Gently press the seal into the slot, working around the circumference of the door. In corner areas in particular ensure that the seal lip is installed without any wrinkles and that the seal is not stretched or compressed.
4. Make sure that the seal is positioned correctly in the slot and flush with the door frame. Correct, if necessary.



Replacing the Power Cord

If the power cord is damaged, it must be replaced by an original spare part. Using a standard power cord with a lower thermal withstand capabilities is prohibited.

Returns for Repair



Prior to returning any materials, please contact our Customer Service Department for a “Return Materials Authorization” number (RMA).

Material returned without an RMA number will be refused.

	 WARNING	Contamination hazard
<p>The incubator may have been used for treating and processing infectious substances, which may have caused contamination of the incubator and its components.</p>		
<p>Prior to return shipment, it is therefore mandatory that all incubator components be properly decontaminated..</p>		
<ul style="list-style-type: none">• Clean the incubator components thoroughly, then disinfect or decontaminate them (depending on application).• Fill in and attach a safety declaration with details on decontamination activities performed to the items that are to be repaired.		

**Maintenance
Returns for Repair**

Disposal

	<div style="display: flex; align-items: center; margin-bottom: 10px;">  <div style="margin-left: 5px;">WARNING</div> </div> <p>Contamination hazard</p> <p>The incubator may have been used for treating and processing infectious substances, which may have caused contamination of the incubator and its components. Prior to disposal, it is therefore mandatory that all incubator components be properly decontaminated.</p> <p>Clean the incubator components thoroughly, then disinfect or decontaminate them (depending on application).</p> <p>Attach a declaration of decontamination with details on decontamination activities performed to the items that are to be disposed of.</p>
---	---

Overview of Materials Used

Component	Material
Thermal insulation components	Glass wool
Printed circuit boards	Coated electrical components contain various plastics materials. Components mounted on circuit boards containing epoxy resin bonder.
Plastic components, general	see material labelling
Exterior housing	Galvanized steel sheet, painted
Device rear panel	Galvanized steel sheet
Outer door	Galvanized steel sheet, painted, + stainless steel (optional)
Door inner panel	Stainless steel
Control panel and display window protective foil	Polyethylene
Heater	Silicone-sheathed resistance heater wires

Component	Material
Interior containers, installed components and shelves	Stainless steel 1.4016 + 1.4301
Door frame seal	Silicone
Glass screen	Sodium silicate glass
Fan wheel	Stainless steel 1.4016
Cables	Plastic-sheathed stranded copper wire
Packaging	Corrugated board, polyethylene film, and styrofoam, chemically untreated wood

WEEE Conformity

This product is subject to the regulations of the EU Waste Electrical & Electronic Equipment (WEEE) Directive 2002/96. It is marked by the symbol shown below.



Thermo Electron has entered into agreements with recycling and disposal companies in all EU Member States for the recycling and disposal of this incubator. For information on how Thermo Electron secures conformity with this directive, on recycling and disposal companies in your country and on the products of Thermo Fisher Scientific, which fall under the RoHS Directive (Restriction of the use of certain hazardous substances in electrical and electronic equipment), please visit the website www.thermo.com/WEEERoHS.

Error Codes

Table 12-1 below lists the error messages that may appear in the control panel display window (see “Error Log” on page 7-10) and provides instructions for clearing such alarms.

Table 12-1 Heratherm Incubator Error Codes



Error Message & Code	Root Cause	Alarm Response	Alarm Clearing Instructions*
Display Error (E002)	Display communication error. The built-in controller was unable to restore communication with the control panel.	Audible alarm activated, alarm relay energized.	Power cycle the device by unplugging, then reconnecting the power cord. If this doesn't solve the problem, call service.
Mirrored Parameter Loaded (E003)	The controller was unable to read the user-specific settings and had to resort to an emergency parameter set held in mirrored storage.	Fallback to mirrored parameter storage. Device continues to run without loss of functionality, including user-specific settings.	Check the last settings, e.g. the defined setpoint.
Factory Parameter Loaded (E004)	The controller was unable to read the mirrored parameter set and had to resort to factory-preset parameters.	Fallback to factory-preset parameters. Audible alarm activated, alarm relay energized. User-specific settings may be lost - for example, the temperature display unit preference, or user programs.	Acknowledge by pressing  .
Default Parameter Loaded (E005)	The controller was unable to read the factory-preset parameters and had to resort to default settings	Fallback to default parameters. User-specific settings will be unavailable - for example, the temperature display unit preference, or user programs. Audible alarm activated, alarm relay energized.	Power cycle the device by unplugging, then reconnecting the power cord. If this doesn't solve the problem, call service.
Power Down Error (E007)	Power has been cut off (power outage) while the device was running.	Audible alarm activated, alarm relay energized.	Check the power supply. Power up then device, then acknowledge the alarm by pressing  .
Config Error (E012)	General device configuration error.	Audible alarm activated, alarm relay energized. No user entries accepted by control panel.	call service.

Table 12-1 Heratherm Incubator Error Codes

Error Message & Code	Root Cause	Alarm Response	Alarm Clearing Instructions*
Sensor Error (E100)	Process sensor damaged. The actual measured value is out of range.	Text message on display; swap control to reference sensor. If both sensors are defective, disable all control circuits.	call service.
Temperature Too High (E101)	Actual measured value exceeds permissible range (heater circuit defective).	Activate process protection, continue control based on set value, show text message on display. (Triac defective.)	call service.
Temperature Too Low (E102)	Actual measured value falls short of permissible range (heater circuit defective). Only on devices equipped with a door switch.	Show text message on display.	call service.
Temperature Not Plausible (E103)	The difference between the control and reference sensors exceeds the maximum permissible deviation, rendering the measurement implausible.	Use the sensor that indicates the higher temperature. Show text message on display.	call service.
Calibration Value Too High (E104)	The calibration reference value calculated on the basis of the user input falls short of the upper limit for calibration references.	Fall back to previous calibration reference, show text message on display.	call service.
Calibration Value Too low (E105)	The calibration reference value calculated on the basis of the user input exceeds the lower limit for calibration references.	Fall back to previous calibration reference, show text message on display.	call service.
Constant Sensor Signal (E106)	None of the decimal places of the A/D-converter output for the process sensor has changed over a specific time period.	Swap control to reference sensor, show text message on display. If both sensors are defective, disable all control circuits.	call service.
Constant Reference Sensor Signal (E107)	None of the decimal places of the A/D-converter output for the reference sensor has changed over a specific time period.	Continue control based on process sensor, show text message on display. If both sensors are defective, disable all control circuits.	call service.
Constant Sample Sensor Signal (E108)	None of the decimal places of the A/D-converter output for the sample sensor has changed over a specific time period.	Text message on display.	call service.
Heating Relay Error (E109)	The voltage measurement has indicated a defect in the heater circuit relay.		call service.
Heating Triac Error (E110)	The voltage measurement has indicated a defect in the triac	Buzzer alarm returns upon acknowledgement.	call service.

Table 12-1 Heratherm Incubator Error Codes

Error Message & Code	Root Cause	Alarm Response	Alarm Clearing Instructions*
Temperature Too High (E111)	The actual measured value exceeds the upper limit of the permissible error range.	Turn off heater until hysteresis is recovered. Show text message on display. Note: This error does not indicate a defective triac.	call service.
Sensor Error (E112)	Reference sensor damaged. The actual measured value is out of range.	Text message on display; continue control on process sensor. If both sensors are defective, disable all control circuits.	call service.
Sensor Error (E113)	Sample sensor damaged. The actual measured value is out of range.	Text message on display.	call service.
Reserved (E114)	N/A	N/A	N/A
Watchdog error (E115)	Watchdog test failed on power-up.	Text message on display.	call service.

* Clearing should mute the audible alarm, de-energize the alarm relay, and clear the message from the control panel display.

Error Codes

Technical Data

Table 13-1 Technical Data - IGS Series

Parameter	Unit	IGS 60	IGS 100	IGS 180
Process				
Temperature deviation from set value at 37° C, spatial	K	±0.7	±0.7	±0.7
Temperature deviation from set value at 37° C, over time	K	±0.2	±0.2	±0.2
Heat-up time (work space unoccupied, from 25°C to 98% of set temperature of 37° C)	min	25	35	35
Recovery time (work space unoccupied, door open for 30 s, to set temperature)	min	5	5	5
Heat dissipation to environment (at set temperature of 37° C and room temperature of 25° C)	W	21 ±10%	26 ±10%	31 ±10%
Overall dimensions				
Height	mm/in	755/ 29.7	855/ 33.7	955/ 37.6
Width	mm/in	530/ 20.8	640/ 25.2	640/ 25.2
Depth	mm/in	565/ 25.2	565/ 25.2	738/ 29.1
Overall weight	kg/lbs	40/88	51/112	65/143
Loading capacity				
Loading capacity per shelf	kg/lbs		25/55	
Max. overall loading capacity per device	kg/lbs	50/110	50/110	75/165
Electrical data				
Power consumption	W	300	540	720
Maximum current	A	2.5	4.5	6.0
Earthing system (e.g. 1/N/PE)		1/N/PE	1/N/PE	1/N/PE
Power line frequency	Hz		60	
Power line voltage +/- 10 %	V		120	
IP protection system			IP 20	
Protection class			I	
Overvoltage category			II	

Table 13-1 Technical Data - IGS Series

Parameter	Unit	IGS 60	IGS 100	IGS 180
Device fusing, building side	A	16		
Device fusing, on PCB	A	2 x 16		
Environmental conditions				
Min. ambient temperature	°C/°F	18/65		
Max. ambient temperature	°C/°F	32/90		
Max. humidity in service, non condensing	% r.F./ % r.H.	80, non condensing		
Min. storage temperature	°C/°F	20/68		
Max. storage temperature	°C/°F	60/140		
Max. humidity in storage, non condensing	% r.F./ % r.H.	90, non condensing		
Post-transport acclimation time	h	2		
Noise level	dB(A)	no Inherent noise		
Pollution degree		2		
Site conditions				
Maximum altitude above sea level	m/y NN	2000/2187		
Minimum side clearance	mm/in	50/2		
Minimum front clearance	mm/in	590 / 23.2	690 / 27.2	814 / 32
Minimum back wall clearance	mm/in	80/3.2		
Minimum bottom clearance	mm/in	200/8		
Minimum top clearance	mm/in	300/12		

Spare Parts and Accessories

Material Number	Description
50127436	Door seal HTM 60
50127437	Door seal HTM 100
50127438	Door seal HTM 180
50127770	Perforated plate IGS 60
50127771	Perforated plate IGS 100
50127772	Perforated plate IGS 180
50127773	Perforated plate IMH 60
50127774	Perforated plate IMH 100
50127775	Perforated plate IMH 180
50123951	Shelf support HTM 60/100
50123952	Shelf support HTM 180
50127861	Retaining spring
50127862	Support rail 60 l
50127863	Support rail 100 l
50127864	Support rail 180 l
50126665	Stacking adapter 60 l
50126666	Stacking adapter 100 l
50126667	Stacking adapter 180 l
50127443	Levelling foot
50127741	Base frame with castors 60 l
50127742	Base frame with castors 100 l
50127743	Base frame with castors 180 l
50127768	Sample sensor, IMH
50127566	Fresh air filter, Heratherm incubators

Device Log

Incubator type:		Part number:	
Serial number:		Service number:	
Location		Operator's note:	
Work carried out	Notes	Date	Signature

Contact

Overview of Thermo Fisher International Sales Organization

Postal address USA:

Thermo Scientific
275 Aiken Road
Asheville, NC 28804
USA

Enquiries from USA/Canada

Sales: +1 866 984 3766
Service: +1 800 438 4851

Enquiries from Latin America

Sales: +1 866 984 3766
Service: +1 866 984 3766

Enquiries from Asia:

China

Sales: +86 10 8419 3588
Service: Toll free 8008105118
Support Mobile 4006505118
or +86 10 8419 3588

India

Sales: +91 22 6716 2200
Service: Toll free 1 800 22 8374
or +91 22 6716 2200

Japan

Sales: +81 45 453 9220
Service: +81 45 453 9224

Enquiries from the Rest of Asia/Australia/New Zealand

Sales: +852 2885 4613
Service: +65 6872 9720

Enquiries from Countries not listed / Rest of EMEA

Sales: +49 6184 90 6940
or +33 2 2803 2000
Service: +49 6184 90 6940

Contact

Enquiries from Europe:

Austria

Sales: +43 1 801 40 0

Service: +43 1 801 40 0

Belgium

Sales: +32 53 73 4241

Service: +32 53 73 4241

Finland/Nordic/Baltic countries

Sales: +358 9 329 100

Service: +358 9 329 100

France

Sales: +33 2 2803 2180

Service: +33 825 800 119

Germany:

Postal Address Germany:

Thermo Electron LED GmbH

Robert-Bosch-Straße 1

D - 63505 Langenselbold

Phone

Sales Toll free 0800 1 536 376

or +49 6184 90 6940

Service Toll free 0800 1 112110

or +49 6184 90 6940

E-Mail info.labequipment.de@thermofisher.com

Italy

Sales +39 02 95059 341

Service +39 02 95059 250

Netherlands

Sales +31 76 579 5555

Service +31 76 579 5639

Russia/CIS

Sales +7 812 703 4215

Service +7 812 703 4215

Spain/Portugal

Sales +34 93 223 0918

Service +34 93 223 0918

Switzerland

Service +41 44 454 1212

UK/Ireland

Service +44 870 609 9203

Sales +44 870 609 9203

Thermo Fisher Scientific, Inc.
81 Wyman Street
P.O. Box 9046
Waltham, MA 02454-9046
United States

www.thermo.com