



Leica AutoStainer XL

Automated slide stainer

Instruction Manual

Leica AutoStainerXL, V2.2 English – 03/2009

Always keep this manual near the instrument!

Read carefully prior to operating the instrument!

Leica

MICROSYSTEMS

NOTE

The information, numerical data, notes and value judgments contained in this manual represent the current state of scientific knowledge and state-of-the-art technology as we understand it following thorough investigation in this field.

We are under no obligation to update the present manual according to the latest technical developments, nor to provide our customers with additional copies, updates etc. of this manual.

For erroneous statements, drawings, technical illustrations etc. contained in this manual we exclude liability as far as permissible according to the national legal system applicable in each individual case. In particular, no liability whatsoever is accepted for any financial loss or consequential damage caused by or related to compliance with statements or other information in this manual.

Statements, drawings, illustrations and other information as regards contents or technical details of the present manual are not to be considered as warranted characteristics of our products.

These are determined only by the contract provisions agreed between ourselves and our customers.

Leica reserves the right to change technical specifications as well as manufacturing processes without prior notice. Only in this way is it possible to continuously improve the technology and manufacturing techniques used in our products.

This document is protected under copyright laws. Any copyrights of this document are retained by Leica Biosystems Nussloch GmbH.

Any reproduction of text and illustrations (or of any parts thereof) by means of print, photocopy, microfiche, web cam or other methods – including any electronic systems and media – requires express prior permission in writing by Leica Biosystems Nussloch GmbH.

For the instrument serial number and year of manufacture, please refer to the name plate at the back of the instrument.

© Leica Biosystems Nussloch GmbH

Published by:

Leica Biosystems Nussloch GmbH
Heidelberger Str. 17 - 19
D-69226 Nussloch
Germany

Phone: +49 (0)6224 143-0
Fax: +49 (0)6224 143-200
eMail: histo_info@leica-microsystems.com
Internet: <http://www.histo-solutions.com>

Table of contents

1.	Important information	6
1.1	Symbols occurring in the text and	6
1.2	Designated use / improper use of the instrument	7
1.3	Qualification of personnel	7
2.	Safety	8
2.1	Safety regulations	8
3.	Instrument features	9
3.1	Overview – instrument	10
3.2	Standard delivery - packing list	12
3.3	Technical Data	13
4.	Installation	14
4.1	Site requirements	14
4.2	Connection	14
4.2.1	Power	14
4.2.2	Water supply	15
4.3	Battery backup - UPS (optional)	16
4.4	Remote alarm (optional)	17
4.5	Fume control system	17
4.6	Oven	17
5.	Operation	18
5.1	The control panel	19
5.2	The main menu	20
5.3	Menu map	21
5.4	Edit a program	22
5.4.1	Entering steps	23
5.4.2	Erasing steps	24
5.4.3	Inserting a blank step into a program	24
5.4.4	Removing blank steps in a program	25
5.4.5	Saving a program	25
5.4.6	Deleting a program	25
5.4.7	Copying a program	26
5.4.8	Viewing a program	27
5.4.9	Checking program compatibility	27
5.5	User-adjustable parameters	29

5.6	Oven	29
5.7	Agitation (Dips)	30
5.8	Rack movement times	31
5.9	Staining	31
5.9.1	Reagent containers	32
5.9.2	Wash system	32
5.9.3	Water saving	33
5.9.4	Loading slide racks	33
5.9.5	Unloading racks from the exit drawer	34
5.9.6	Unloading racks from other stations	34
5.9.7	Interrupting staining	35
5.9.8	Aborting a rack	36
6.	Cleaning and Maintenance	37
6.1	Cleaning the instrument	37
6.1.1	Wash containers	37
6.1.2	Reagent containers	37
6.1.3	Slide racks	37
6.1.4	Oven	37
7.	Trouble shooting	38
7.1	Instrument failures	39
7.2	Information and warnings	40
7.2.1	During staining	40
7.2.2	During editing programs	41
7.2.3	During SetUp	42
8.	Warranty and service	43
	APPENDIX 1	44
	User-adjustable parameters	44
	APPENDIX 2	45
	Consumables and accessories	45
	APPENDIX 3	46
	Compatible staining programs	46
	Glossary	48
9.	EC Declaration of Conformity	51

1. Important information

The instruction manual for the Leica AutoStainer XL includes chapters dealing with the following subjects:

- Chapter 1** **Manual structure** including:
- Table of contents
 - Important information on this handbook.
- Chapter 2** **Safety**
- Read this chapter before you attempt to operate the instrument!
- Chapter 3** **Instrument features**
- General description
 - Technical data
- Chapter 4** **Installation**
- Site requirements
 - Installation
- Chapter 5** **Operation**
- Control elements
 - Menu map
- Chapter 6** **Trouble shooting**
- Chapter 7** **Cleaning and maintenance**
- Chapter 8** **Warranty and service**
- Appendix 1** **User-adjustable parameters**
- Appendix 2** **Consumables and accessories**
- Appendix 3** **Compatible staining programs**
- Glossary**

1.1 Symbols occurring in the text and their meaning



Warnings and cautions appear in a grey box and are marked by a warning triangle  .



Notes, i. e. important information for the user appear in a grey box and are marked by an information sign  .

(5)
(Fig. 5) **Numbers in parentheses refer to positions in the illustrations or to the illustrations themselves.**

Instrument type:

All information in this instruction manual applies only to the instrument type indicated on the title page.

A nameplate with the instrument serial number is fixed on the back of the instrument.

Required information:

For all inquiries it is important to state the following:

- instrument type
- serial number.

General

This instruction manual includes important information related to the operating safety and maintenance of the instrument.

The instruction manual is an important part of the product. It must be read carefully and completely before setup and first use of the instrument and must be kept near the instrument at all times.

If additional requirements on accident prevention and environmental protection exist in the country of operation, this instruction manual must be supplemented by appropriate instructions to ensure compliance with such requirements.



Be sure to read and comply with the safety instructions, warnings and cautions in chapter 2, even if you are already familiar with the operation and use of other Leica products.

1.2 Designated use / improper use of the instrument

- The AutoStainer XL has been designed for staining applications in medicine, biology and industry.
- The instrument may be operated only according to the instructions contained in this manual.
- Any other use is considered an improper use of the product.

1.3 Qualification of personnel

- The AutoStainer XL may be operated only by trained laboratory personnel.
- All laboratory personnel designated to operate the AutoStainer XL must read this instruction manual carefully and must be familiar with all technical features of the instrument before attempting to operate the AutoStainer XL.

2. Safety

2.1 Safety regulations

This instrument has been built and tested in accordance with the safety regulations for electrical measuring, control, regulating and laboratory devices.

In order to maintain this condition and ensure safe operation, the operator must observe all the instructions and warnings contained in this instruction manual.

For current information about applicable standards, please refer to the CE declaration of conformity on our Internet site:

www.histo-solutions.com

The AutoStainer XL is the result of an extensive research program to provide an innovative stainer which meets the quality requirements of the modern laboratory, as well as:

- high throughput,
- flexibility,
- safety.

The AutoStainer XL achieves its high throughput by means of an innovative slide rack transfer mechanism which allows continuous loading of up to 11 racks of 30 slides each.

The flexibility of AutoStainer XL also permits simultaneous processing of slide racks according to different staining protocols so that Papanicolaou and Hematoxylin/Eosin staining can be conveniently performed at the same time, without reprogramming or reagent changes.

The AutoStainer XL incorporates all of the features which ensure high flexibility, convenience and above all, quality staining. A fan-forced oven is available to quickly dry slides and optimized wash stations result in rapid removal of excess reagent. The minimum-carryover design of the slide racks ensures that there are no drips and reagent life is extended.

The AutoStainer XL is safe to use and has an integral fume control system. Rack loading and unloading is achieved by a unique two-drawer system which means virtually no exposure to fumes.

The outstanding flexibility, throughput and quality-staining capability of AutoStainer XL has set a new standard in staining excellence.

3. Instrument features

3.1 Overview – instrument



Abb. 1



Abb. 2

Front view

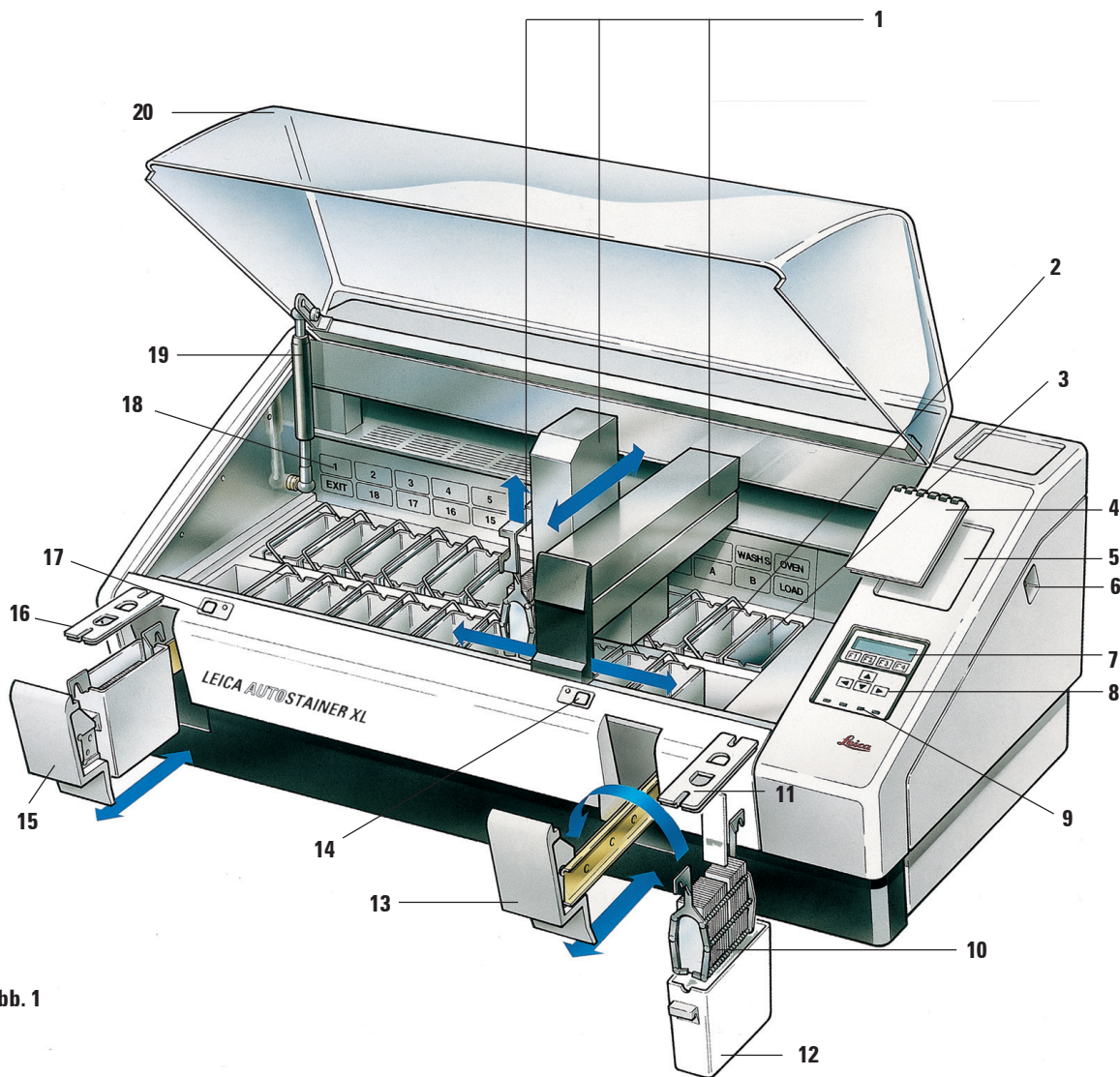
1. Transfer mechanism
2. Wash stations
3. Oven
4. Program pad
5. Program pad recess
6. ON/STOP switch
7. Display screen
8. Keypad
9. LED indicators
10. Slide rack
11. Lid
12. Reagent container
13. Load drawer
14. Load LED and key
15. Exit drawer
16. Slotted lid
17. Exit LED and key
18. Container map on fume filter cover
19. Lid support
20. Lid

Rear panel

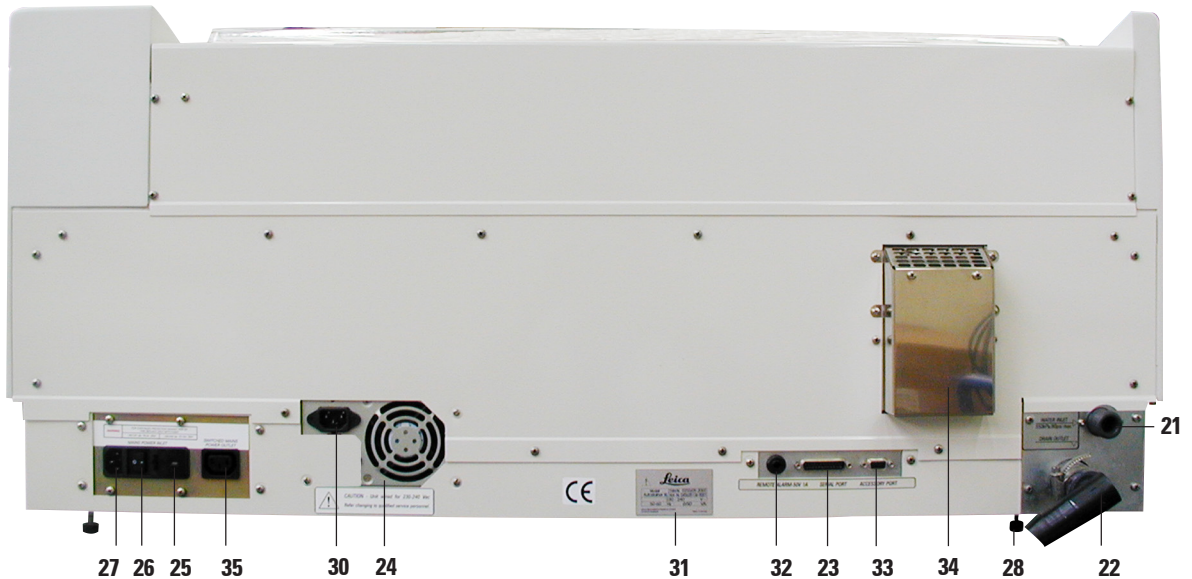
21. Water inlet
22. Drain outlet
23. Serial port
24. Power supply
25. Oven voltage selector
26. Mains switch (ON/OFF)
27. Mains outlet
28. Feet, adjustable
29. Power jumper cable
30. Power supply inlet
31. Rating and serial number plate
32. Remote alarm socket, 50 V 1 A max
33. Accessory port
34. Exhaust air duct
35. Power supply outlet

3. Instrument features

3.2 Standard delivery - packing list

Standard delivery:

1	Leica ST5010 basic instrument (100-120 V/50-60 Hz)	
1	accessories kit (14 0456 35660) consisting of:	
	- 22 reagent vessels with lids	14 0475 33659
	- 5 wash vessels	14 0456 35268
	- 5 slide racks, metal	14 0456 33919
	- 2 lids with slots for reagent vessels	14 0475 34486
	- 1 jumper cable - supply system	14 0411 34604
	- 1 remote alarm connector	14 6844 01005
	- 1 hose clamp	14 0422 31972
	- 1 angular connecting nozzle for hose	14 0475 33669
	- 1 V filter 3/4	14 0456 36101
1	activated carbon filter	14 0474 32273
1	filter cover	14 0456 35240
1	drip tray for paraffin (heating) (inside the instrument)	14 0456 35216
1	dye log block (attached to the instrument)	14 0456 35459
1	water supply hose with seal	14 0474 32325
1	drain hose	14 0475 35748
1	power cable USA-C-J	14 0411 13559
1	operating manual Leica AutostainerXL G/E (+ language CD)	14 0456 80001
	- 1 reference manual as appendix, English only (dye logs, etc.)	

3.3 Technical Data

Specimen slide throughput:	at least 200 specimen slides per hour (depending on the selected program - up to 600 slides per hour)
Loading capacity:	11 slide racks
Slide rack capacity:	30 specimen slides
Total number of stations:	26
Total number of reagent stations:	at least 18
Reagent container volume:	450 ml
Number of wash stations:	max. 5
Oven:	1
Oven chamber temperature:	ambient or 30 °C to 65 °C
Incubation time setting:	from 0 sec. up to 99 min., 59 sec
Load/unload stations:	1 each
Permanent memory capacity:	15 programs, up to 25 program steps each
Operating temperature range:	15 °C to 35 °C
Relative humidity:	max. 80 %, non-condensing
Dimensions (W x D x H):	109 cm x 67 cm x 51 cm
Weight:	65 kg
Voltages:	110 V - 120 V, 50 Hz - 60 Hz 230 V - 240 V, 50 Hz - 60 Hz

4. Installation

Instructions on how to install the instrument are provided in this chapter. A diagram and description of components is also given. Finally, the procedure for replacement of the fume filter is outlined.

4.1 Site requirements

The AutoStainer XL requires a solid bench of dimensions 1.090 mm long and 670 mm deep. The instrument must be located within 3 meters of a tap and drain.

The power requirements for the AutoStainer XL are:

8 amps: at 110 volts

4 amps: at 240 volts

The voltage selector and other internal components are set by the manufacturer to suit the country of sale.



The voltage selector setting must not be altered by the user.

The AutoStainer XL requires connection to a laboratory water tap with mains pressure fitting.

4.2 Connection

4.2.1 Power

- Connect the power cord to the mains outlet ((**28**) page 11).
- Connect the power jumper cable to the power supply outlet ((**30**) page 11) and to the power supply inlet ((**32**) page 11).

Refer to Figure 10 on page 11.

4. Installation

How to switch on:

1. Connect the power cord to the mains power socket and, if applicable, switch power ON at the mains socket.
2. Set the ON/STOP switch at the side of the unit to STOP.
3. Set the ON/OFF switch at the rear of the unit to ON.
4. Set the ON/STOP switch to ON.

The instrument will then sound 3 short beeps and the **Main Menu** will be displayed.

When the instrument is not in use set the ON/STOP switch at the side to STOP.

The ON/OFF switch at the rear of the instrument should be left ON.



The instrument must never be operated without the power jumper cable.

The instrument must be connected to an earthed mains power outlet socket only.

4.2.2 Water supply

Connect the water hose to the water inlet at the rear of the unit. Screw the other end of the hose to the cold water tap. The hose has a 3/4 inch BSP fitting. Slowly turn the tap on fully.



Ensure that the water filter is present when fitting the water inlet hose. Failure to do so may result in leakage of water.

Drain hose

Connect the drain hose to the drain outlet on the rear of the unit.

4. Installation

4.3 Battery backup - UPS (optional)

An uninterruptible power supply (UPS) can be used to permit staging of slides to continue during brief mains power failures.

A small UPS can be connected using the power jumper lead, as shown in Figure 15.

The UPS should be rated at 200 VA for 5 minutes. Heating in the oven will not be maintained by the UPS.

The UPS must be rated for use with the local mains voltage. Your distributor can recommend a suitable UPS.

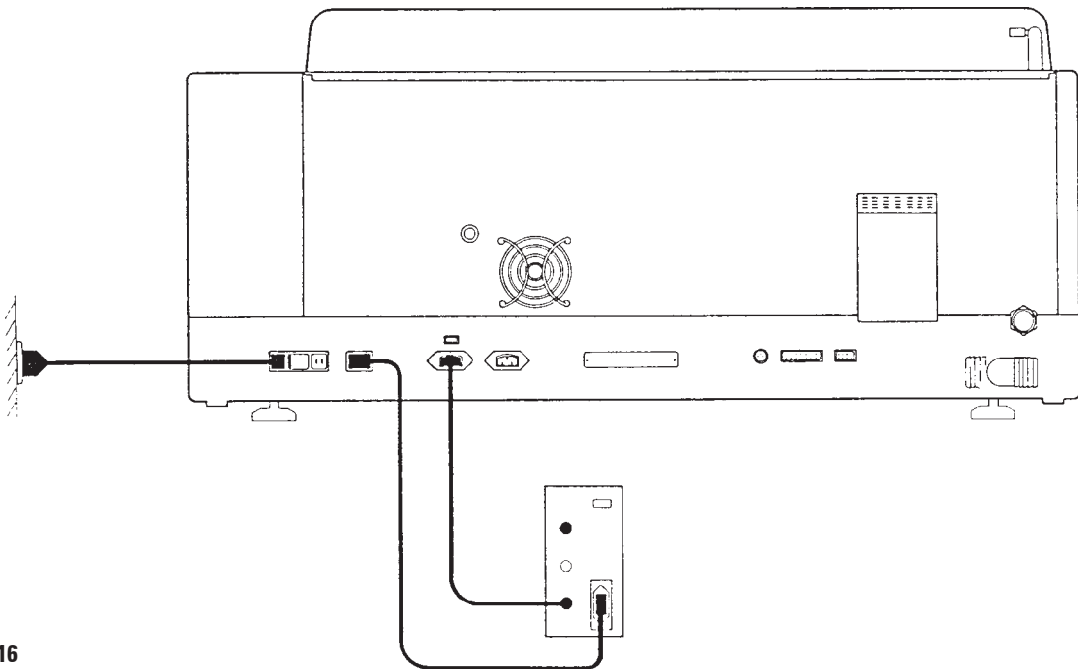

Fig. 16

4.4 Remote alarm (optional)

The remote alarm option is a latched relay that is voltage-isolated from the rest of the instrument. When an alarm condition occurs (either a major failure of the instrument, or loss of mains power during a processing run whilst a battery backup unit is fitted) the alarm circuit closes, sounding the alarm.



A battery-powered remote alarm must be used if you require the remote alarm to sound when the mains power fails.

Ensure that the instrument is turned ON and press any key to reset the alarm. If mains power failed during a run, it may be necessary to put the ON/STOP switch at the side of the instrument to STOP, and then to ON again.

The remote alarm will only operate during loss of mains power if a battery backup unit is fitted. Your distributor can provide connection details for the remote alarm.

The remote alarm connected to the instrument must be rated at less than 1 amp and a maximum of 50 Volts.

Connect the remote alarm to the alarm socket at the rear of the unit, using a 6.25 mm phono jack.

4.5 Fume control system

Fumes are exhausted through the activated carbon filter which must be changed every three months (with average usage).

To remove a filter, lift out the plate covering the filter. Refer to Figure 2. Remove the filter, using the tabs. Replace with a new filter and fit the cover into place.

4.6 Oven

Fit the wax tray into the bottom of the oven.

5. Operation

Introduction

This chapter describes how to operate AutoStainer XL. It includes sections on how to use the control panel functions and other indicators, how to create and edit programs and how to stain slides.

AutoStainer XL offers some unique features not available in other stainers and these are explained in subsequent sections. Firstly, slide racks are loaded and unloaded by means of drawer, not by opening the lid. If the instrument is free to accept a rack for staining the Load LED will be on. After loading, the Load key **must** be pressed to inform the instrument to begin processing. Similarly, if a rack is finished staining in the Exit drawer the Exit LED will be on. The Exit key **must** be pressed to inform the instrument when the rack is removed. Programs can finish at any station. However, if the EXIT drawer is not the last step then **the LCD will inform you** of the station to unload from. In this case, the lid will have to be opened to remove the rack.

AutoStainer XL can accept racks whenever the Load LED is on and process up to 11 racks simultaneously.

Each rack can be processed according to any of the 15 programs, provided that the reagents are available and the program chosen is compatible (no conflicting sequence) with programs already being used.

Communication

Communication with AutoStainer XL is via the control panel, load and unload keys and associated indicators and audible signals.

5.1 The control panel

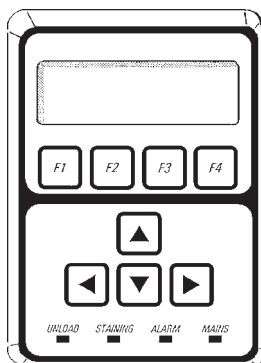

The control panel consists of an LCD display, the keypad and four LEDs.

The display

The display is a four-line LCD with backlighting. The fourth line is usually reserved for commands associated with the function keys [F1] to [F4]. A flashing cursor appears beneath user-changeable settings.

The keypad

The membrane keypad incorporates 4 function keys and 4 arrow keys. The function keys perform the action indicated immediately above them on the fourth line of the display. The arrow keys move the cursor in the direction indicated. They are also used to select digits and other settings.



Contact with solvents, use of sharp instruments or excessive force may damage the keypad.

The LED indicators

The four LEDs are located below the arrow keys and have the following functions. The unload LED (yellow flashing) indicates that a rack has been completed and is ready to be removed from a station other than the exit drawer. The staining LED (yellow) is lit when staining is in progress. The alarm LED (red) indicates that an instrument error has occurred. The mains LED (green) signals that mains power is available (ON at ON/OFF switch, ON at ON/STOP switch).

5. Operation

Load and exit keys and indicators

The load and exit keys and associated LED indicators are located adjacent to the load and exit drawer. For further information, see Pages 32 and 33.

Audible signals

There are four types of audible signals given:

- short single beep: indicates key press;
- short double beep: indicates unacceptable key press or error message;
- long double beep: operator attention required to remove a completed rack;
- continuous tone: indicates unit failure.

5.2 The main menu

When the AutoStainer XL is turned ON at the ON/STOP switch, the following Main Menu will be displayed and the instrument will give 3 beeps.

AutoStainer XL		V2.0	
Main Menu			
Stain	Edit	SetUp	PC

The modes of operation of the instrument are:

- Stain: to stain slides
- Edit: to create, view or change programs
- Setup: to set, view or alter parameters such as oven temperature and the number of dips (amount of agitation) upon entering a reagent station
- PC: for service use only

5.3 Menu map

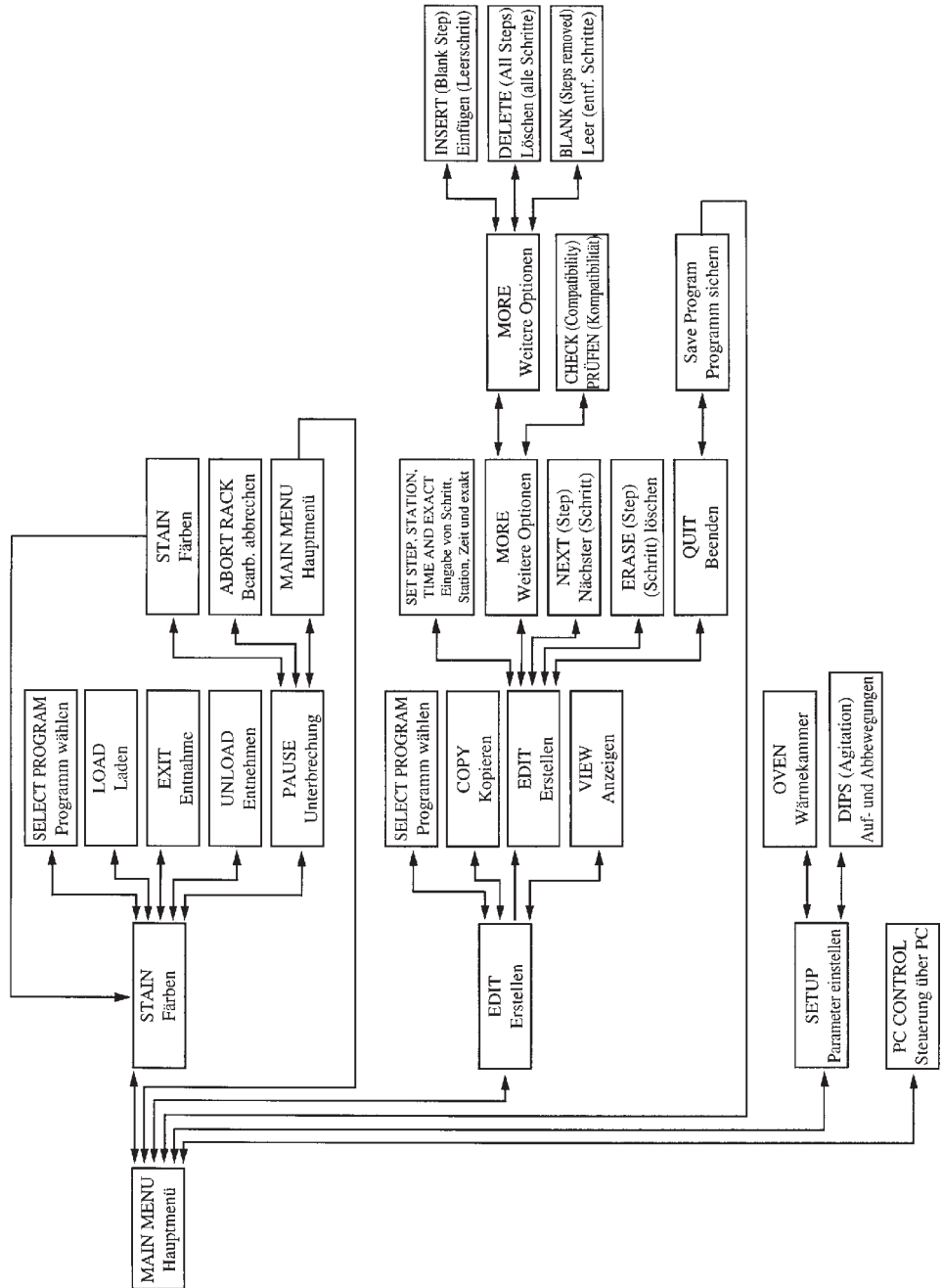

Fig. 21

5. Operation

5.4 Edit a program

AutoStainer XL can store 15 programs numbered from 1 to 15 in permanent memory. Programming is performed using a simple, menu-driven system and all information is entered via the keypad.

A program consists of 25 steps, some of which may be blank. A step consists of the following information:

- the step number
- the station
- the immersion time
- whether the immersion time must be achieved exactly or not.

The step number defines the order in which the stations are used. The immersion time is the time the rack is fully immersed in a station.



As there is potential for timing clashes to occur when multiple racks are present in the instrument, steps which require precise timing are designated as 'exact' in the program. Immersion times at these steps are given priority and are achieved to within ± 1 second. Racks at steps not marked as 'exact' will receive attention as the head becomes available.











Programs which are assigned to racks currently being stained cannot be altered or copied to.

For an overview of the programming structure, refer to the menu map on Page 21.

5.4.1 Entering steps

1. Press **[F2] Edit** from the Main Menu.
2. Select the desired program number using the  and  keys.
3. Press **[F2] Edit**.

The first step of the program is then displayed under the following headings:

- step: the step number,
 - stn: the station number or description,
 - time: the immersion time, in minutes and seconds,
 - exact: whether the immersion time is critical or not.
4. With the cursor under the step number, use the  and  keys to move between step 1 to 25 of the program. Alternatively, press **[F2] Next** to move to the next step.
 5. To enter program information, use the  and  keys to position the cursor beneath the appropriate heading. Scroll through the options or alter the digits using the  and  keys. Fill in the program details, using the  and  keys to move to the next heading as each item in the step is completed.



An immersion time of 00:00 means that this step will be omitted.

6. Repeat steps 4 and 5 until the program is complete.



If you wish the rack to finish in the EXIT drawer, insert this as the last step.

7. To save the program, see page 24.

5. Operation

5.4.2 Erasing steps

Information contained in a step may be erased leaving a blank step.

1. To select the program, see steps 1 to 3, page 22,
2. To select the step to be deleted, see step 4, page 22,
3. Press **[F3]** *Erase*.
The step will be left blank.
You may enter new step details, if desired.
4. To save the program, see page 24.

5.4.3 Inserting a blank step into a program

This function is used to insert an additional step into an existing program.

1. Select the program, see steps 1 and 2, page 22.
2. Press **[F2]** *Edit*.
3. Select the step number where the new (blank) step to be inserted.
4. Press **[F1]** *More*.
5. Press **[F1]** *More*.
6. Press **[F1]** *Insert*.
7. If you wish to proceed, press **[F1]** *Yes*.
A blank step will be inserted at the step selected in (3).



The steps following the blank step will be renumbered. Step 25 is lost when a blank step is inserted.

8. Continue to edit the program as required.
9. To save the program, see page 24.

5.4.4 Removing blank steps in a program

This function is used to remove blank steps where a program has been edited by deleting one or more steps. Steps will be sequentially renumbered in the same sequence as the original program.

1. Select the program (see steps 1 and 2, page 22).
2. Press **[F2]** *Edit*.
3. Press **[F1]** *More*.
4. Press **[F1]** *More*.
5. Press **[F3]** *Blank*.
6. If you wish to proceed, press **[F1]** *Yes*. The blank steps will be removed and subsequent steps will be renumbered.
7. To save the program, see page 24.

5.4.5 Saving a program

When the program is complete, to save it permanently:

1. From the **Edit Program** screen, press **[F4]** *Quit*. You now have the options of saving the edited program **[F1]**, leaving the program as it was before the changes were made **[F2]**, or continuing editing **[F4]**.
2. Press **[F1]** to save the program, or
3. Press **[F2]** to leave the program unchanged, or
4. Press **[F4]** to continue editing the program.

5.4.6 Deleting a program

This function is used to delete all steps in a program.

1. Select the program (see steps 1 and 2, page 22).
2. Press **[F2]** *Edit*.
3. Press **[F1]** *More*.
4. Press **[F1]** *More*.
5. Press **[F2]** *Delete*.
6. If you wish to proceed, press **[F1]** *Yes*.
7. To save the program (which now contains no steps), see above.

5. Operation



5.4.7 Copying a program

This function is used to copy a program into another program number.

1. Select the program to be copied (see steps 1 and 2, page 22)
2. Press **[F1]** *Copy*.



If an empty program has been selected, an informative message will be given.

3. Using the  and  keys, select the program number to be copied into.
4. Press **[F1]** *Copy*.



**If the program number selected is not empty, an informative message will be given.
If the program selected is assigned to a rack currently being stained, the copy is not allowed and an informative message will be given.**

A confirmatory message will be momentarily displayed if the copy is successful.



5. If you wish to copy the program to another program number, repeat Steps 3 and 4.
6. Press **[F4]** *Cancel* to exit from copying.

5.4.8 Viewing a program

To view a program:

1. Select the program using steps 1 and 2, page 22.

2. Press **[F3]** *View*.

Up to four steps can be viewed simultaneously. Use the  and  keys to view other steps.

3. Press **[F4]** to return to the previous screen.

5.4.9 Checking program compatibility

This function is used to check whether two programs can be run simultaneously. Programs cannot be run together if they need access to the same exact station at the same time or if they contain the same two stations but in reverse order, as in the following two programs:



Program 1	Program 2
Station 1	Station 1
Station 2	Station 3
Station 3	Station 2

1. Select the program (see steps 1 and 2, page 22).

2. Press **[F2]** *Edit*.

3. Press **[F1]** *More*.

4. Press **[F2]** *Check*.

5. Using the  and  keys, select the program number that you wish to check compatibility with.

6. Press **[F2]** *Check*. - The compatibility check is performed and a subsequent message will inform you whether the programs are compatible.

7. If the programs are not compatible, an explanation will be given. Press **[F4]** to continue.

8. Repeat Steps 5 and 6 to check compatibility with other programs.

5. Operation

9. Press **[F4]** to return to the program selected at step 1.



Many of the program incompatibility situations arise from allocation of water wash stations. Therefore, these stations are user-selectable.

Appendix 3 gives some examples of common staining protocols which are compatible.

5.5 User-adjustable parameters

There are several user adjustable parameters on the AutoStainer XL, which apply to the instrument's operation independently of the program selected. These are:

- . oven temperature;
- . amount of agitation on entry to a station, as the number of dips;
- . agitation time, specified as the time taken for a complete agitation cycle, i.e. up and down;
- . rack withdrawal time, specified as the time taken for the rack to be withdrawn from a station;
- . rack entry time, specified as the time for the rack to be lowered into a station.



5.6 Oven

You can set the temperature of the oven in the range 30 - 65 °C, or select heating to be OFF.



The oven will operate at the setting selected during the entire staining process, whether or not is being used. The selected temperature will be displayed during staining.

To set, view or change the oven setting:

1. Press **[F3]** *SetUp* from the **Main Menu**.
The current oven setting is then displayed on the first line.
To alter the setting:
 2. Press **[F1]** *Oven*.
 3. Press **[F1]** to turn the oven on, or
Press **[F2]** to turn the oven off, or
use the  and  keys to alter the oven temperature.
 4. Press **[F4]** to return to the **SetUp** screen.
The new oven setting will now be displayed.
 5. Press **[F4]** to return to the **Main Menu**.

5. Operation

5.7 Agitation (Dips)

You can set the number of times the slide rack is moved up and down (dips) on entry to a reagent station, in the range OFF/1-20/continuous.





If continuous is selected, only one slide rack will be processed in the instrument at any one time.

To view or change the setting:

1. Press **[F3]** *SetUp* from the **Main Menu**.
The current setting will be displayed on the second line.

To alter the setting:

2. Press **[F2]** *Dips*.
3. Press **[F1]** to turn the dips on, or
Press **[F2]** to turn the dips off, or
Use the  and  keys to alter the number of dips.
4. Press **[F4]** to return to the **SetUp** screen.
The new Dips setting will now be displayed.
5. Press **[F4]** to return to the **Main Menu**.



The time for a single Dip (down and up) is selected in Rack movement times. Use this as a guide when setting the number of dips. If the immersion time is shorter than the time to do the set number of dips, only the number of dips that fit into the immersion time will be done.



5.8 Rack movement times

You can set the rack agitation, withdrawal and entry times to suit your run time and agitation requirements. Refer to Appendix 1 for the allowable ranges.

To view or change the settings:

1. Press **[F3]** *SetUp* from the **Main Menu**.
2. Press **[F3]** *Move*.

The current settings are displayed shown as the seconds taken for each movement, i.e. agitation cycle time (Dip), rack withdrawal time (Up) and rack entry time (Down).

3. To change any of the values, press **[F1]** *Dip*, **[F2]** *Up* or **[F3]** *Down* to position the cursor beneath the appropriate value.
4. Use the  and  keys to alter the setting.
5. Repeat steps 3 and 4 as required.
6. Press **[F4]** *Return* to return to the **SetUp** screen.
7. Press **[F4]** *Return* to return to the **Main Menu**.

5.9 Staining

This section provides a guide to staining slides.

The AutoStainer XL can accept slide racks whenever the load station is empty and stain them according to the program selected for each rack. Different programs may be used simultaneously provided they are compatible. To check whether programs are compatible, refer page 26.

5. Operation

5.9.1 Reagent containers

Reagent containers can be individually removed for filling. For use, fill the reagent containers to the line marked on the inside (450 ml capacity) and place into position in the instrument consistent with the programs you wish to run.

There is an area for a label on the end of the containers just above the handle pivots.

The container map inside the instrument (see Figure 11) defines the station numbers. Ensure that the reagent containers are correctly seated and that the handles are over to the side and will not obstruct slide rack movement. Lids are provided to reduce evaporation while the reagent containers are not in use.

The Load and Exit drawer containers can be filled with a reagent if desired. However, the instrument will not control the immersion time in these stations.

5.9.2 Wash system

The wash system consists of five wash stations each capable of holding one slide rack. Water enters the wash station from the base and exits from the overflow lip at the top left hand edge.



Wash stations have a locating pin and can only be inserted one way. Take care when fitting or removing wash stations as the seals may be damaged by excessive force. Wet the 'O' ring seal before fitting a wash station.

To use the wash system, slowly turn the laboratory tap on fully. The flow control valve in the AutoStainer XL will limit the total water flow in the wash stations to 8 liters/minute.



If the water flow drops below this level for any reason the wash period specified in the program may have to be extended.

5.9.3 Water saving

The AutoStainer XL is fitted with a water-saving feature which stops the flow of water when none of the wash stations is in use and the excess reagent has been flushed from them.

5.9.4 Loading slide racks



Slide racks are inserted into the instrument via the load drawer only, situated at the front right hand side of the instrument. To operate the drawer, grasp and push up with several fingers on the release lever on the underside of the drawer and pull outwards.

To load a slide rack:

1. Select **[F1] Stain** from the **Main Menu**.
The instrument will take a few seconds to initialize.



If a rack is already loaded then the Abort Menu will be displayed. Press (F1) *Stain* to continue.

2. Select the required program number using the  and  keys.
Check to see that the load drawer is empty (the **(Load)** LED will be lit)
Open the drawer and insert the slide rack, ensuring that it is correctly seated. Close the drawer.
3. Press the **(Load)** key.
If the program is compatible with programs in use then the **(Load)** LED will go off and the rack will be processed according to the chosen program, otherwise an informative message will be given and the rack will not be processed.
4. To load additional slide racks, repeat steps 2 and 3.



If the instrument is processing a rack, there may be a delay before additional racks begin processing.

5. Operation

5.9.5 Unloading racks from the exit drawer

When a rack is in the exit station, the **(Exit)** LED will be on and the beeper will sound every 30 seconds.

To unload a rack from the exit drawer:

1. Open the exit drawer carefully and remove the rack. Alternatively, remove the entire reagent container from the drawer and replace it with another.
2. Close the drawer and press the **(Exit)** key. *The LED will then go off.*



If the (Exit) key is not pressed the instrument will be unable to finish the processing of further racks which require this station.



5.9.6 Unloading racks from other stations

If the final step in a program is not the exit drawer, the **(Unload)** LED on the control panel will flash when processing is complete.

To unload the rack:

1. Press **[F1]** *Unload*.

A confirmatory message will be given while the head completes its current operation. The station number of the completed rack will then be displayed.

2. Select the station number of the rack you wish to remove using the  and  keys (if more than one rack is completed), or
3. Press **[F4]** *Cancel* if you do not wish to unload the rack. The instrument will then resume processing.

4. Press **[F1]** *Unload*.
Open the lid and remove the rack.
5. Press **[F1]** *Done*.
6. Repeat steps 2 to 5 to remove other completed racks.

5.9.7 Interrupting staining

The staining can be interrupted to:

- edit a program not currently being used for staining,
- change the general instrument **SetUp** parameters,
- allow access to the instrument to check/change reagents,
- abort staining of one more racks.

To interrupt staining:

1. Press **[F4]** *Pause* to return to the **Abort** screen.



**If staining is interrupted, immersion times during *Pause* will not be identical to those in the chosen program(s).
If no racks are loaded then the **Main Menu** will be displayed.**

2. To abort a rack, refer to page 35 or
3. Press **[F1]** *Stain* to continue staining, or
4. Press **[F4]** *Main Menu* to return to the **Main Menu**.



You may now edit programs not currently in use or change the instrument **SetUp** parameters.

To resume staining, press **[F1]** from the **Main Menu**.

5. Operation

5.9.8 Aborting a rack

To abort staining of a rack:

1. Press **[F4]** *Pause* from the **Staining** screen.
2. Press **[F2]** *Abort rack*.
3. Using the  and  keys, select the station containing the rack you wish to abort.
4. Press **[F2]** *Abort*.
5. Remove the rack, as instructed. Press **[F1]** *Done*.
6. To abort other racks, repeat steps 3 to 5.
7. Press **[F4]** *Cancel* to exit from the **Abort** screen.
8. Press **[F1]** to continue staining or press **[F4]** to return to the **Main Menu** as desired.

6.1 Cleaning the instrument

Clean interior stainless steel surfaces with detergent and rinse with water. Clean the head covers by wiping with a damp cloth.



The head contains sensitive electronic components. Do not use liquids directly on this region. Wipe clean only.

The drain system may be flushed with 5% Sodium Hypochlorite to inhibit microbial growth. If used, ensure that this solution does not remain in contact with any metal parts for prolonged periods and flush well with water after use. Exterior (painted) surfaces can be cleaned with a mild detergent and wiped with a damp cloth.



Avoid the use of solvents on exterior surfaces and especially on the control panel and lid.

Wipe the control panel carefully with a damp cloth.

6.1.1 Wash containers

Remove the wash containers and clean with detergent.

6.1.2 Reagent containers

Wash in warm water with detergent.



Do not wash reagent or wash containers in an automatic dishwasher.

6.1.3 Slide racks

Clean with detergent or laboratory cleaning agent as required.

6.1.4 Oven

Periodically check the wax tray at the bottom of the oven and clean it if excessive wax dripping has occurred.

7. Trouble shooting

Introduction

AutoStainer XL continually monitors itself and will report any errors as they occur. If a minor error occurs during staining the instrument will attempt to correct the problem first. If it is unsuccessful then a message will be given and the instrument will wait for the user to rectify the problem.

Some faults cause the alarm to sound. The alarm can be turned off by pressing **[F1]** *Quiet*.

[F2] *Pause* can be used to pause staining from the error message display.

A list of instrument messages and their meanings follows.

7.1 Instrument failures

Mains power fail	This warning message indicates that mains power has failed. It will only appear if a UPS is fitted. Refer to page 15 for further information.
Power supply fail	The power supply has failed and must be serviced.
Make sure that the head is free of obstruction	<p>The rack transfer arm (head) has stalled during operation. The most likely causes of this are:</p> <ol style="list-style-type: none">1. Reagent container not properly seated2. Handle not properly positioned3. Lid left on reagent container, or4. Slide rack bent <p>The instrument will attempt to restart staining once the problem is rectified.</p>
Head stalled	Even after attempting to restart staining the head is still unable to move freely. Remove any obstructions and recommence staining or contact your service agent if the problem persists.
Fume system blocked	The outlet duct at the rear of the instrument is blocked. Remove the blockage.
Oven failure	The oven has failed and must be serviced. The instrument is still operational at all other stations but slide drying must be performed outside the AutoStainer
Oven overheating	The most likely cause of this message is a blockage in the oven. Check that the slot at the base of the oven is not obstructed.
Remove obstruction and replace rack on hook	The rack might have disengaged from the hook. Rectify the cause of the problem (e.g. reagent container not properly seated) and replace rack on hook.

7. Trouble shooting

7.2 Information and warnings

7.2.1 During staining

Program (x) cannot be used for staining Program (x) is either empty, or consists entirely of blank or zero time steps.

Program (x) is not compatible with programs in use Program (x) is incompatible with a program assigned to a rack(s) currently being stained. The rack(s) must be completed before program (x) can be used. Refer to Page 26.

Ensure a rack is in the Load drawer and close the drawer The load drawer must be closed before the instrument can pick up the rack.

Ensure the Exit drawer is empty and close the drawer The Exit drawer must be closed before a rack can be placed into it.

7.2.2 During editing programs

Station (x) and Station (y) are in reverse order	The message occurs during a compatibility check of two programs. The stations specified are in the opposite order in the two programs which cannot be used concurrently.
The steps after Exit will be ignored	Exit occurs before the end of the program and the remainder of the steps will be ignored.
Program (x) is in use for staining and cannot be altered	A program which is currently being used for staining cannot be altered. Copy the program to another program number and then edit it.

7. Trouble shooting

7.2.3 During SetUp

SetUp lost. Default Set-Up used.

Programs and SetUp have been lost and must be entered again.

Battery backed RAM Failure! Service is required.

The internal memory must be replaced. Contact your service agent.

Caution: increasing Dips might extend some station times

Increasing the amount of agitation while racks are currently being stained might extend exact immersion times. Selecting continuous agitation will result in only one rack being progressed at a time.

Warranty

Leica Biosystems Nussloch GmbH guarantees that the contractual product delivered has been subjected to a comprehensive quality control procedure based on the Leica in-house testing standards, and that the product is faultless and complies with all technical specifications and/or agreed characteristics warranted.

The scope of the warranty is based on the content of the concluded agreement. The warranty terms of your Leica sales organization or the organization from which you have purchased the contractual product shall apply exclusively.

Technical service information

If you require technical service or replacement parts, please contact your Leica sales representative or dealer who sold the product.

Please provide the following information:

- Model name and serial number of the instrument.
- Location of the instrument and name of the person to contact.
- Reason for the service call.
- Date of delivery.

Decommissioning and disposal

The instrument or parts of the instrument must be disposed of in compliance with the local laws.

APPENDIX 1

User-adjustable parameters

Item	Factory setting	Changeable	Range
Slide per rack	N/A	N/A	0-30
Racks in the instrument	N/A	Y	0-11
Stations	18 reagent 5 wash 1 oven 1 load drawer 1 exit drawer	N	0-18 0-5 0-1 1 0-1
Programs	15	N	15
Steps per program	25	N	25 (Note: some steps can be blank)
Immersion time	N/A	Y	0 sec - 59 min 99 sec (Note: 0 seconds means the step is omitted)
Timing accuracy ('Exact')	N/A	Y	± 1 second ('Exact') -0, +infinity (not 'Exact')
Oven temperature	N/A	Y	Off/30 - 65 °C
Agitation (Dips)	N/A	Y	Off/1-20/ Continuous
Agitation time (Dip) (seconds/cycle)	2	Y	1-4
Rack withdrawal time (Up) (seconds)	9	Y	4-9
Rack entry time (Down) (seconds)	2	Y	2-4

Consumables and accessories**Consumables**

Activated carbon filter

Accessories

Slide rack adapter Sakura

Slide rack adapter Medite / Meisei 20

Slide rack adapter Medite / Meisei 30

Slide rack adapter, Shandon

Frame for individual large slides

Blocking plug for wash station

O ring hook

O ring for wash container

Drain hose

Chimney adapter

Inlet hose

Reagent container handle

Wash containers

Slide rack 30 - 1 unit

Plastic slide rack 30 - 1 unit

Output rack

Reagent container holder

Lid for reagent containers inside the instrument

Slotted lid for reagent container

Program pad

Instruction manual

APPENDIX 3

Compatible staining programs

Reagent	Station	Program 1H&E			Program 2 Papanicolaou		
		Step	Time	Exact	Step	Time	Exact
	Oven	1	10:00	Y			
Xylene	1	2	2:00	N			
Xylene	2	3	2:00	N			
100% Alcohol	3	4	2:00	N			
100% Alcohol	4	5	2:00	N			
70% Alcohol	5	6	1:00	N	1	1:30	N
Wash	Wash 1	7	2:00	N	2	2:00	N
Hematoxylin	6	8	5:00	Y	3	3:30	Y
Wash	Wash 2	9	2:00	N	4	2:00	N
Acid Alcohol	7	10	0:02	Y	5	0:05	Y
Wash	Wash 3	11	3:00	N	6	2:00	N
Scott's	8	12	3:00	Y	7	4:00	Y
Wash	Wash 4	13	3:00	N	8	2:00	N
95% Alcohol	9				9	1:30	N
OG 6	10				10	2:00	Y
95% Alcohol	11				11	1:30	N
95% Alcohol	12				12	1:30	N
EA 50	13				13	2:30	Y
Eosin	14	14	2:00	Y			
95% Alcohol	15	15	0:30	y	14	1:30	Y
100% Alcohol	16	16	2:00	N	15	1:30	Y
100% Alcohol	17	17	2:00	N	16	1:30	Y
100% Alcohol	18	18	2:00	N	17	1:30	y
Xylene	Exit	19			18		



Washes 1 to 4 (and the stations between) are used in the same sequence in both programs. - These programs are compatible with each other but not with programs on page 47.

Compatible staining programs

Reagent	Station	Program 1H&E			Program 5 Hx Counterstain		
		Step	Time	Exact	Step	Time	Exact
Oven		1	10:00	Y			
Xylene	1	2	2:00	N			
Xylene	2	3	2:00	N			
100% Alkohol	3	4	2:00	N			
100% Alkohol	4	5	2:00	N			
70% Alcohol	5	6	1:00	N			
Wash	Wash 1	7	2:00	N			
Hematoxylin	6	8	5:00	Y	1	5:00	Y
Wash	Wash 2	9	2:00	N	2	2:00	N
Acid-Alcohol	7	10	0:02	Y	3	0:02	Y
Wash	Wash 3	11	3:00	N	4	3:00	N
Scott's	8	12	3:00	Y	5	3:00	Y
Wash	Wash 4	13	3:00	N	6	3:00	N
Eosin	14	14	2:00	Y			
95% Alcohol	15	15	0:30	Y			
100% Alkohol	16	16	2:00	N	7	2:00	N
100% Alkohol	17	17	2:00	N	8	2:00	N
100% Alkohol	18	18	2:00	N	9	2:00	N
Xylene	Exit	19			10		

Glossary

CARRYOVER	The amount of REAGENT carried from one STATION to another by the SLIDE RACK.
CURSOR	Flashing bar on LCD beneath user-changeable data.
DIP/DIPS/DIPPING	The SLIDE RACK is moved up and down a programmable number of times on entry to a STATION.
DISENGAGE	The process by which the HEAD detaches itself from the SLIDE RACK after PUTDOWN or DIPPING.
ENGAGE	The process by which the HEAD attaches itself to the SLIDE RACK prior to PICKUP.
EXACT IMMERSION	The IMMERSION time is achieved within 1 second.
EXIT DRAWER	Drawer into which SLIDE RACKS are placed by the instrument for subsequent collection by the user.
FUME EXTRACTION	A fan draws fumes through a filter which removes dangerous SOLVENT vapors.
HEAD (TRANSFER ARM)	XYZ device used to PICKUP, PUTDOWN, ENGAGE, DISENGAGE, DIP and move SLIDE RACKS from STATION to STATION.
IMMERSION TIME	The time a SLIDE RACK spends in a STATION. Timed from end of PUTDOWN to start of PICKUP.
LCD	The Liquid Crystal Display situated on the control panel.
LEDs	Light Emitting Diodes situated on the control panel and near LOAD and EXIT DRAWERS.

LOAD DRAWER	Drawer into which SLIDE RACKS are placed by the user and from which they are taken by the instrument for STAINING.
NON-EXACT IMMERSION	The IMMERSION TIME is achieved within $-0, +$ infinity seconds, i.e. it specifies a minimum time period only.
OVEN	STATION through which warm air is blown in order to dry SLIDES and adhere tissue sections to them.
PC	Personal computer based on the original IBM architecture.
PICKUP	The SLIDE RACK is withdrawn from a STATION by the HEAD in such a way as to minimize CARRYOVER.
PROGRAM	Series of STEPS by which a SLIDE RACK undergoes STAINING in the instrument.
PUTDOWN	The SLIDE RACK is placed in a STATION by the HEAD.
REAGENT	Chemical used for STAINING.
REAGENT STATION	Container holding REAGENT into which SLIDE RACKS are placed by the instrument.
SETUP	Parameters which apply to the operation of the instrument independently of the program used, i.e. OVEN temperature and DIPS setting.
SLIDE	Glass microscope slide 25 mm x 75 mm x 1 mm.
SLIDE RACK	Holds SLIDES to ease handling by the instrument.
SOLVENT	Organic liquid e.g. Xylene, Ethanol.
STAINING	The process by which tissue sections are stained.

Glossary

STATION	Location in the instrument where part of a STAINING sequence takes place.
STEP	Defined by the STATION, IMMERSION TIME and timing accuracy for one discrete event in the STAINING sequence.
TRANSFER ARM	See HEAD.
UNLOAD	The user removes a SLIDE RACK from the EXIT DRAWER or from the station in which it completes its programmed sequence.
UPS (BATTERY BACKUP)	Uninterruptable power supply which allows STAINING to continue during brief mains power failures.
WASH STATION	Container through which water flows to wash REAGENT from a SLIDE RACK and the SLIDES in it.



EC Declaration of Conformity



We herewith declare, in exclusive responsibility, that the

Leica ST5010 – Automated slide stainer

was developed, designed and manufactured to conform with the

- Directive 2006/95/EC of the European Parliament and of the Council (Low Voltage)
- Directive 2004/108/EC of the European Parliament and of the Council (electromagnetic compatibility)
- Direktive 98/79/EC of the European Parliament and of the Council (in-vitro diagnostic medical devices)

The following harmonized standards were applied:

- **EN 61010-1: 2001**
Safety requirements for electrical equipment for measurement, control and laboratory use
Part 1: General requirements
- **EN 61010-2-010: 2003**
Safety requirements for electrical equipment for measurement, control and laboratory use
Part 2-010: Particular requirements for laboratory equipment for the heating materials
- **EN 61326: 2006**
Electrical equipment for measurement, control and laboratory use -
EMC requirements -
Part 1: General requirements
- **DIN EN 61010-2-101: 2002**
Safety requirement for electrical equipment for measurement, control and laboratory use
Part 2-101: Particular requirements for in vitro diagnostic (IVD)
- **EN 14971: 2007**
Medical devices - Application of risk management to medical devices
- **EN 591: 2001**
Instruction for use for in vitro diagnostic instruments for professional use

In addition, the following in-house standards were applied:

- **DIN EN ISO 9001: 2000.**
Quality management systems - Requirements

Leica Biosystems Nussloch GmbH
Heidelberger Str. 17-19
D-69226 Nussloch
May 15, 2008

Anne De Greef-Safft
President Biosystems Division

