

Operating Instructions

Sartorius CP | Gem^{plus} Series

CPA, GCA and GPA Models

Electronic Micro-, Analytical and Precision Balances and Precious Metal Scales

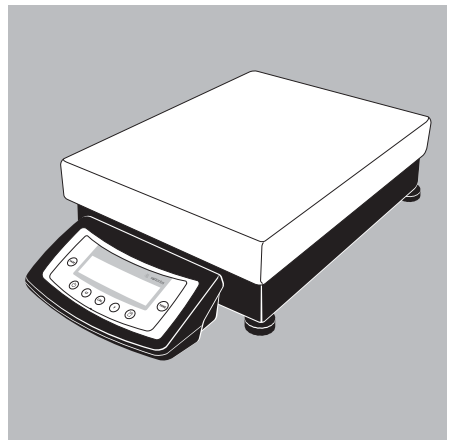
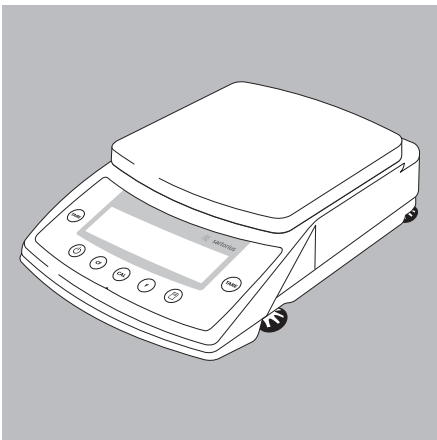
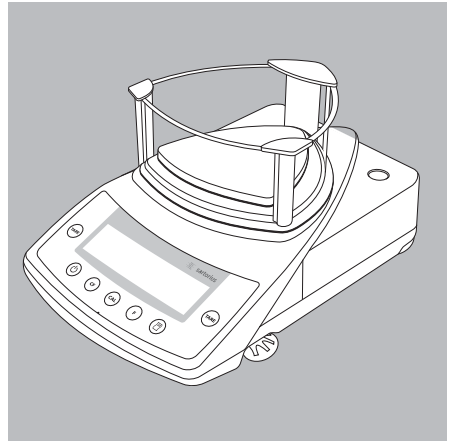
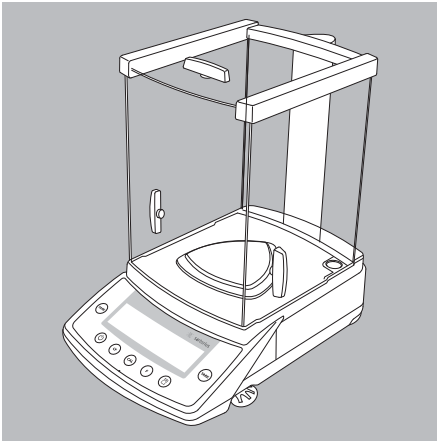

Contents

Safety Precautions	3	Generating a Printout	51
Getting Started	5	ISO/GLP-compliant Printout/Record	53
Installation	6	Interface Port	55
Operation	15	Data Input Format	59
Overview of Display and Operating Elements	15	Pin Assignment Charts	62
Basic Weighing Function	16	Cabling Diagram	63
Below-Balance Weighing	18	Troubleshooting Guide	64
Calibration and Adjustment	20	Preparing CPA2P.. Models for Transport	65
Configuration	25	Care and Maintenance	66
Printing the Parameter Settings	25	Instructions for Recycling	68
Setting the Parameters (Menu Codes)	26	Overview	69
Parameter Settings (Overview)	27	Specifications	69
Setting IDs, Time, Date and Display Brightness	32	Accessories (Options)	81
Application Programs	35	Declarations of Conformity	84
Net-total Formulation	36	EC Type-approval Certificate	87
Counting	40	Plates and Markings	88
Reference Balance/Scale for Counting	40		
Weighing in Percent	44		
Animal Weighing/Averaging	47		
Toggling between Weight Units	50		

Safety Precautions

Safety Instructions

- Please read these operating instructions carefully before using your balance to prevent damage to the equipment.
- △ Do not use this equipment in hazardous areas/locations.
- △ The balance housing may be opened only by Sartorius service technicians who have been trained at the factory.
- △ Make sure you disconnect the balance from power before connecting or disconnecting peripheral devices to or from the balance.
- △ If you operate the equipment under ambient conditions that require higher safety standards, you must comply with the installation regulations applicable in your country.

When cleaning your balance, make sure that no liquid enters the balance housing; use only a slightly moistened cloth to clean the balance.

Installation

- △ Make sure the voltage rating printed on the AC adapter is identical to your local line voltage.
- Proceed with extreme caution when using pre-wired RS-232 connecting cables, as the pin assignments may not be compatible with Sartorius equipment. Check all pin assignments against the cabling diagrams and disconnect any lines that do not match.

- △ If there is visible damage to the equipment or power cord, disconnect the equipment from power and lock it in a secure place to ensure that it cannot be used for the time being.
- Connect only Sartorius accessories and options, as these are optimally designed for use with your balance. The operator shall be responsible for any modifications to Sartorius equipment and for any connection of cables or equipment not supplied by Sartorius and must check and, if necessary, correct these modifications and connections. On request, Sartorius will be happy to provide information on operating specifications (in accordance with the Standards for defined immunity to interference).
- Do not open the balance. If the seal is broken, this will result in forfeiture of all claims under the manufacturer's warranty.
- If you have any problems with your balance, please contact your local Sartorius office, dealer or service center.

Equipment Supplied

The equipment supplied includes the components listed below:

- CPA2P, CPA2P-F
- Balance with display and control unit
- Kit of standard accessories
- AC adapter
- Dust cover
- Filter pan and lid (model CPA2P-F only)
- Spacer (model CPA2P-F only)

The kit of standard accessories contains the following:

- Weighing pan
- Interior draft shield
- Hanger for below-balance weighing
- 1 brush
- 1 pair of forceps
- 1 piece of lint-free cloth

- CPA Balances with a Readability of ≤ 0.1 mg; CPA...-DS, GCA Scales
- Balance/scale with display and control unit
- Electronics box (model CPA225D only)
- Draft shield with base plate (not available for the CPA64-WDS)
- AC adapter
- Weighing pan
- Shield disk
- Centering plate (only for CPA...DS)
- In-use dust cover
- Gem tray (GCA scales only)

- CPA Balances with a Readability of 1 mg (except for the CPA...-DS models)
- Balance with display and control unit
- Draft shield with cover
- AC adapter
- Weighing pan
- Pan support
- Base plate
- In-use dust cover

- CPA-Balances with a Readability of 0.01 g/0.1 g, GPA Scales
- Balance/scale with display and control unit
- AC adapter
- Weighing pan
- Gem tray (GPA scales only)
- In-use dust cover

- CPA34001S, CPA34001P, CPA16001S, CPA12001S, CPA34000
- Balance with display and control unit
- AC adapter
- Weighing pan
- In-use dust cover

Getting Started

Storage and Shipping Conditions

- Do not expose the balance to extreme temperatures, moisture, shocks, blows or vibration.

Unpacking the Balance

- After unpacking the equipment, please check it immediately for any external damage
- If damage is evident, refer to the instructions under “Safety Inspection” in the chapter entitled “Care and Maintenance.”
- Save the box and all parts of the packaging for any future transport. Disconnect all cables before packing the balance for shipping!

Installation

Choose a location that is not subject to the following negative influences:

- Heat (heater or direct sunlight)
- Drafts from open windows and doors
- Extreme vibrations during weighing
- Excessive moisture

Conditioning the Balance

Moisture in the air can condense on the surfaces of a cold balance whenever it is brought into a substantially warmer place. If you transfer the balance to a warmer area, make sure to condition it for about 2 hours at room temperature, leaving it unplugged from AC power.

Seal on Balances Verified for Use in Legal Metrology in the EU*

EU legislation requires that a control seal be affixed to verified balances of accuracy class (II). The control seal consists of a sticker with the “Sartorius” logo. If the seal is broken, the verification becomes null and void and the balance must be re-verified.

* Including the Signatories of the Agreement on the European Economic Area

Installation

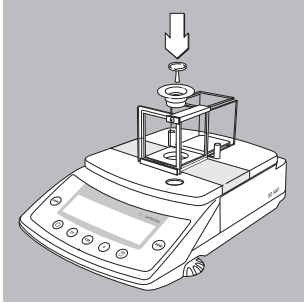

Model CPA2P

- Remove the adhesive tape from the chamber doors
- Place the components listed below inside the chamber in the order given:
 - Interior draft shield
 - Weighing pan

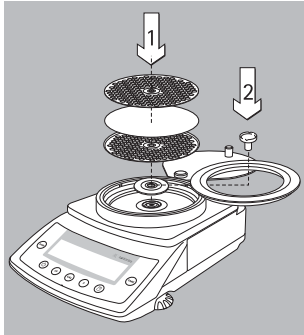

Model CPA2P-F

1) Weighing filters of up to 125 mm Ø:

- Lift the chamber lid gently and turn it to the left or right
- Place the components listed below inside the chamber in the order given:
 - Interior draft shield
 - Filter pan
 - Cover the sample (filter) with the lid

2) Weighing with the standard weighing pan (20 mm Ø):

- Lift the chamber lid gently and turn it to the left or right
- Place the components listed below inside the chamber in the order given:
 - Interior draft shield
 - Spacer ring
 - Weighing pan

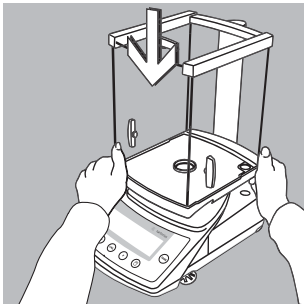

Balances with an Analytical Draft Shield

- ⚠ Check the sliding lock device on the back of the draft shield; make sure it is in the “open” position (to the right).
- Position the draft shield carefully on the balance

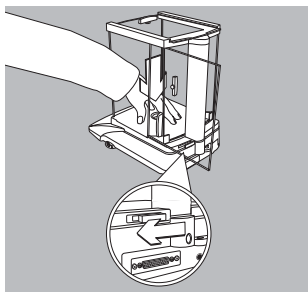

- Secure the draft shield by pressing lightly on the draft shield base and moving the sliding lock device to the left

Triangular weighing pan shape

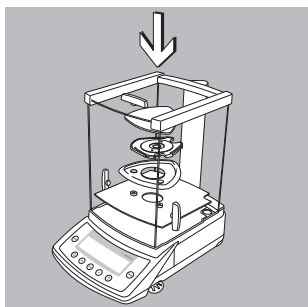

- Place components inside the chamber in the following order:
 - Base plate
 - Shield ring
 - Pan support
 - Weighing pan
 - Gem tray (GCA scales only)

Round weighing pan shape

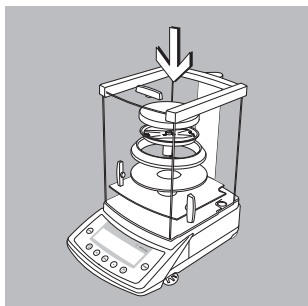

- Place components inside the chamber in the following order:
 - Base plate
 - Centering plate
 - Shield ring
 - Pan support
 - Weighing pan

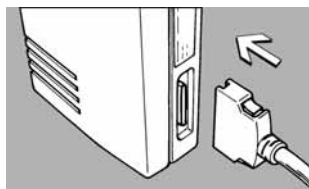

Connecting Model CPA26P, CPA225D (-OCE) to the Electronics Box

- Plug the male connector on the cable into the female connector on the electronics box
- ⚠ Do not exchange the balance or electronics box with a component of a different balance!

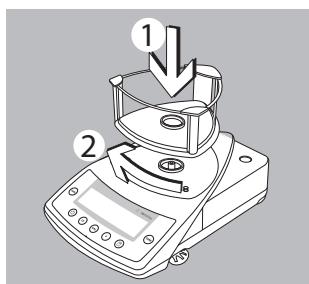

Balances with a 3-Sided Draft Shield

- Place draft shield on the balance with the cover opening in front on the right
- Turn the draft shield clockwise until it is firmly in position

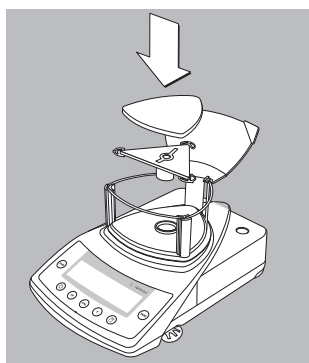

- Place components inside the chamber in the following order:
 - Base plate
 - Weighing pan receptor
 - Weighing pan
- To access the weighing chamber from the side, remove side panels as desired

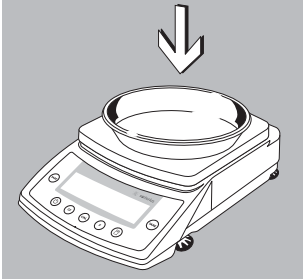

Balances/Scales with a Rectangular Weighing Pan and a Weighing Capacity up to 10 kg

- Place the components listed below on the balance/scale in the order given:
 - Weighing pan
 - Gem tray (GPA scales only)

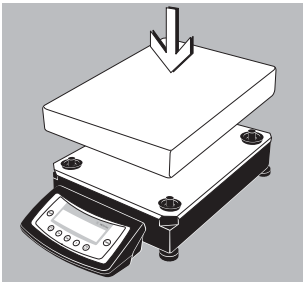

Balances with a Rectangular Weighing Pan and a Weighing Capacity over 10 kg

- Place the weighing pan on the balance

Connecting the Balance to AC Power/ Safety Precautions

- Use only original Sartorius equipment.
The AC adapter meets the requirements of IP20 in accordance with EN 60529.
- For AC adapters with higher protection ratings or for an external rechargeable battery pack, please see “Accessories.”

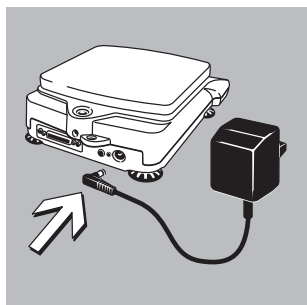

CPA26P, CPA225D:

- Insert the right-angle plug from the AC adapter into the jack on the electronics box.

All other balances with a weighing capacity up to 10 kg:

- Insert the right-angle plug from the AC adapter into the jack on the balance.
- Connect the AC adapter to an electrical outlet (mains supply)

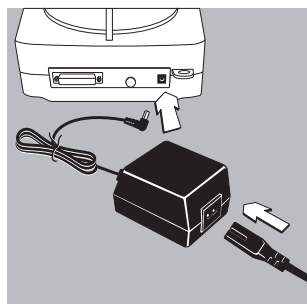

AC Adapter with Country-specific Power Cord

Some models come with separate country-specific power cords for the AC adapter. In Europe, use only original Sartorius AC adapter part no. 6971983.

- Connect the angle plug to the balance/scale
- Select the power cord for your area and connect it to the AC adapter
- Plug the power cord into the wall outlet (mains)

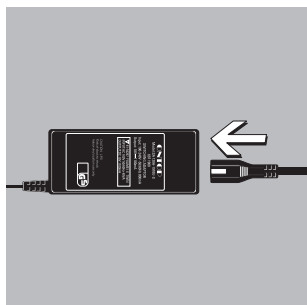

Connect the power cord to the AC adapter (on balances with weighing capacities up to 10 kg)

- Use an original Sartorius AC adapter with a wide input voltage range (100 to 240 V~), order no. 6971966, and replaceable power cord:
6900900 (Europe)
6900901 (US/CDN)
6971945 (UK)
6900905 (AUS)
6900902 (ZA)

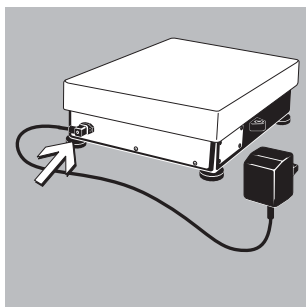

- Balances with a Weighing Capacity over 10 kg:
 - Insert the right-angle plug into the jack and tighten the screw.
 - Connect the AC adapter to an electrical outlet (mains supply)

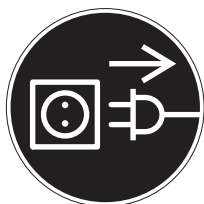

Safety Precautions

Plug-in AC Adapter:

The AC adapter rated to Class 2 can be plugged into any wall outlet without additional safety precautions.

Universal AC Adapter 6971966:

The AC adapter rated to Class 1 can be plugged into any wall outlet without additional safety precautions.

The ground terminal is connected to the balance housing, which can be additionally grounded for operation. The data interface is also electrically connected to the balance housing (ground).

Note:

This equipment has been tested and found to comply with the limits pursuant to part 15 of FCC Rules. These limits are designed to provide reasonable protection against harmful interference. This equipment generates, uses and can radiate radio frequency energy and, if not installed and used in accordance with these instructions, may cause harmful interference to radio communications.

For information on the specific limits and class of this equipment, please refer to the Declaration of Conformity. Depending on the particular class, you are either required or requested to correct the interference.

If you have a Class A digital device, you need to comply with the FCC statements as follows: “Operation of this equipment in a residential area is likely to cause harmful interference in which case the user will be required to correct the interference at his own expense.”

If you have a Class B digital device, please read and follow the FCC information given below:

However, there is no guarantee that interference will not occur in a particular installation. If this equipment does cause harmful interference to radio or television reception, which can be determined by turning the equipment off and on, the user is encouraged to try to correct the interference by one or more of the following measures:

- Reorient or relocate the receiving antenna.
- Increase the separation between the equipment and receiver.
- Connect the equipment into an outlet on a circuit different from that to which the receiver is connected.
- Consult the dealer or an experienced radio/TV technician for help.

Before you operate this equipment, check which FCC class (Class A or Class B) it has according to the Declaration of Conformity included. Be sure to observe the information of this Declaration.

Connecting Electronic Peripheral Devices

- Make sure to unplug the balance from AC power before you connect or disconnect a peripheral device (printer or PC) to or from the interface port.

Warmup Time

To deliver exact results, the balance must warm up as listed below after initial connection to AC power or after a relatively long power outage.

- Model CPA2P..., CPA26P...: at least 4 hours
- All other precision and analytical models: at least 30 minutes

Only after this time will the balance have reached the required operating temperature.

Using Verified Balances in Legal Metrology:

- Allow the equipment to warm up for at least 24 hours after initial connection to AC power.

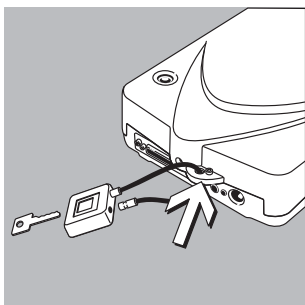

Antitheft Locking Device on Balances with a Weighing Capacity of up to 10 kg

- To secure the balance at the place of installation, fasten a chain or a lock to the lug located on the rear panel of the balance (order no.: LC1).

Leveling the Balance

Purpose:

- To compensate for unevenness at the place of installation

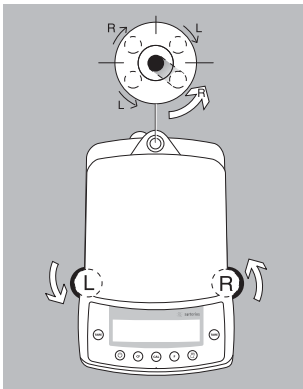

Leveling Balances with a Weighing Capacity of up to 10 kg

Only the 2 front feet are adjusted to level the balance.

- Retract the two rear feet (only on models with a rectangular weighing pan).
 - Turn the 2 front feet as shown in the diagram until the air bubble is centered within the circle of the level indicator.
- > In most cases this will require several adjustment steps.
- For weighing heavy samples: Extend the 2 rear feet until they touch the surface on which the balance rests (only on models with a rectangular weighing pan).

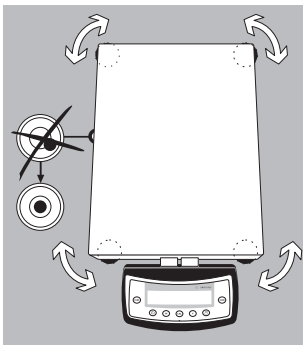

Leveling Balances with a Weighing Capacity of over 10 kg

- Adjust the leveling feet until the air bubble is centered within the circle on the level indicator.

Operation

Overview of Display and Operating Elements

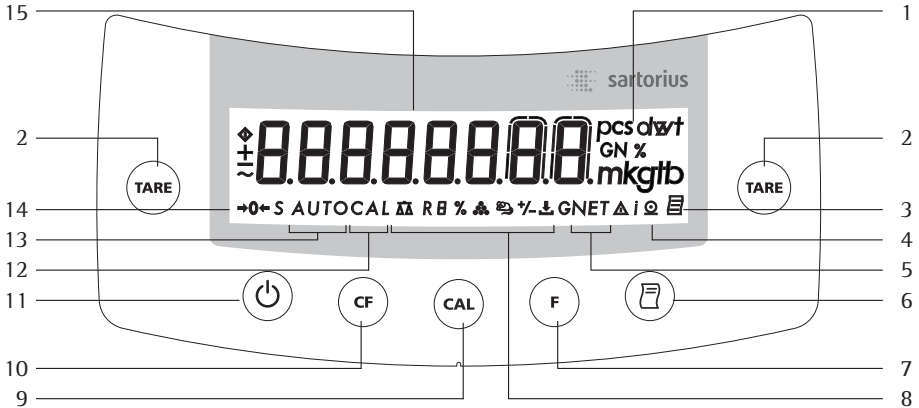

Position Designation

- 1 Weight units
- 2 Tare key
- 3 Symbol: “GLP printing mode active”
- 4 Symbol: “Printing mode active”
- 5 Display: Data in memory for net-total formulation program
- 6 Data output: Press this key to output readout values to the built-in data interface.
- 7 Function key: Start application program
- 8 Symbols for active application
- 9 Start calibration/adjustment routine

Position Designation

- 10 Delete (Clear Function)
This key is generally used to cancel functions.
 - Quit application program
 - Cancel calibration/adjustment routine
- 11 On/off
- 12 Display: Calibration/adjustment function
- 13 Display: Animal weighing with automatic start
- 14 Symbols for stand-by mode or zero range
- 15 Weight value displayed in selected weight unit

Basic Weighing Function

Purpose

The basic weighing function can be used alone or in combination with an application program (counting, weighing in percent, etc.).

Features

- Taring the balance
- Assigning IDs to weights (as needed)
- Printing weights

Using Verified Balances as Legal Measuring Instruments in the EU*

The type-approval certificate for verification applies only to non-automatic weighing instruments. For automatic operation with or without auxiliary measuring devices, you must comply with the regulations applicable to the place of installation.

- Before using the balance as a legal measuring instrument, calibrate and adjust it at the place of use using the built-in motorized calibration weight; for details, see “Calibration and Adjustment” in the next chapter.
- The temperature range (°C) indicated on the verification label may not be exceeded during operation.

Example:

BD BL 200

+10°C to +30°C

0°C to +40°C isoCAL

Ⓜ

Working with CPA2P, CPA26P...

Models:

Working with the microbalance requires a steady hand and a smooth, uninterrupted technique.

Use forceps or other suitable utensil to place the sample on the weighing pan.

Perform a number of test measurements before you begin weighing, to allow the temperature inside the weighing chamber to adjust to the ambient temperature outside the chamber. Otherwise, if the chamber door was closed for a longer period of time prior to beginning weighing, the sudden change in temperature inside the chamber when you open the door might affect the weight readout. This is why a series of test measurements is recommended; the repeated opening and closing of the weighing chamber door, at the same rate of speed as will be used during the actual weighing sequence, will both compensate this difference in temperature to some extent and help you develop a smooth working rhythm.

Place the sample gently on the weighing pan. The weight readout should stabilize within 15 to 20 seconds. The degree of precision attained increases in proportion as the weighing operations become more consistent.

* Including the Signatories of the Agreement on the European Economic Area



Preparation

A circle in the upper right-hand corner of the display indicates that the balance was disconnected from power. This symbol is shown, for example, the first time the balance is put into operation, or after a power outage.



- Switch on the balance: Press (⏻)
- > All symbols on the display light up briefly.

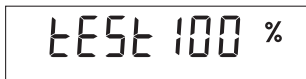

- > The balance performs a display test.



- Tare the balance, if necessary: Press (TARE)
When you turn on the balance, the ◊ symbol is displayed until you press a key.
If the ◊ symbol is displayed during operation, this indicates that the processor is performing a function and cannot receive further commands at the moment.

Additional Functions

- Switching off the balance: Press (⏻)
A circle in the lower left-hand corner of the display indicates that the balance has been switched off and is in stand-by mode.



Filter Weighing with Model CPA2P-F

The CPA2P-F filter microbalance comes with a filter pan that has a utilizable diameter of 125 mm as standard equipment. Place the filter on the pan and close the lid.

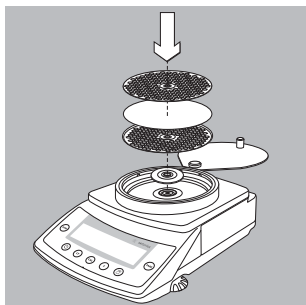

Analytical and precision balances:

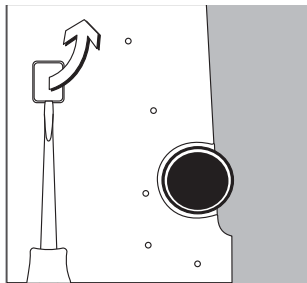

Below-Balance Weighing

A port for a below-balance weighing hanger is located on the bottom of the balance (for models with a weighing capacity of 12 kg or more, see chapter on “Accessories.”

- Below-balance weighing is not permitted in legal metrology.
- Open cover plate on the bottom of the balance.

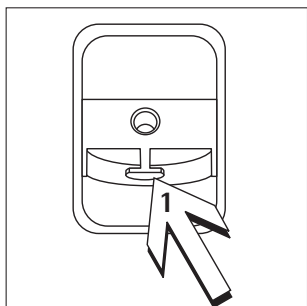

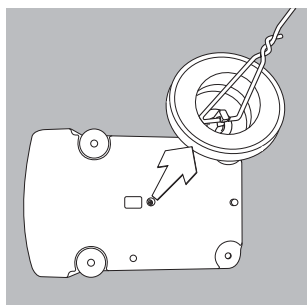

- Using the built-in hanger 1: Attach the sample (e.g., using a suspension wire) to the hanger.
- If necessary, install a shield for protection against drafts.

Microbalance CPA2P..:

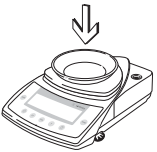

- Remove the brass screw
- Suspend the below-balance weighing hook supplied from the hanger
- If necessary, install a shield for protection against drafts

Example
Simple Weighing

Step	Key (or instruction)	Display/Data Output
1. Switch on the balance. Self-test is performed, followed by automatic initial tare function.	()	+ 0.0 g
2. Place container on the balance (in this example, 11.5 g).		+ 11.5 g
3. Tare the balance.	(TARE)	+ 0.0 g
4. Place sample in container on balance (in this example, 132 g).		+ 132.0 g
6. Print weight.	()	N + 132.0 g

Calibration and Adjustment

Purpose

Calibration is the determination of the difference between the weight readout and the true weight (mass) of a sample. Calibration does not entail making any changes within the balance.

Adjustment is the correction of any difference between the measured value displayed and the true weight (mass) of the sample, or the reduction of the difference to an allowable level within the maximum permissible error limits.

Using Verified Balances as Legal Measuring Instruments in the EU*

Before using your balance as a legal measuring instrument, you must perform “internal calibration/adjustment” at the place of installation after the warmup period.

Features

Calibration/adjustment can be performed only when:

- there is no load on the balance,
- the balance is tared, and
- the internal signal is stable.

If these conditions are not met, an error message is displayed (*Err 02*).

Adjustment can be performed

- automatically following calibration (*F 10 1*) or
- manually, at operator discretion, after calibration (*F 10 2*)

- The weight displayed for the sample on the balance must not differ from the nominal weight by more than 2%.
- You can use any of the following weight units to calibrate/adjust the balance: g, kg, lb (*F 11 1* to *3*, factory setting: *F 11 1*)

You can block calibration/adjustment of the balance as follows:

- Select menu code *F 9 7*, or
- Close the menu access switch on the back of the balance
- You can have calibration/adjustment start automatically when a specified time or temperature limit is reached (isoCAL function; *F 15 3*).
- You can have calibration and adjustment results documented as an ISO/GLP-compliant printout; see the chapter on ISO/GLP-compliant Printout/Record.

External Calibration/Adjustment in Verified Balances of Accuracy Class II

- When the balance is used in legal metrology, external calibration/adjustment is blocked by a seal over the menu access switch.

* Including the Signatories of the Agreement on the European Economic Area

Internal Calibration/Adjustment

The menu code setting $1\ 9\ 3$ must be selected in the Setup menu.

Inside the balance housing is a motorized calibration weight which is applied and removed automatically for internal calibration.

- Activate calibration: Press (CAL)
- > The built-in calibration weight is applied automatically.
- > The balance is calibrated.
- > If “Calibrate, then auto adjust in one operation” is selected in the Setup menu, the balance is now adjusted automatically.
- > The internal calibration weight is removed.



Important note for calibration/adjustment of the CPA2P-F model: position the cover before calibration/adjustment

Calibration and Adjustment Sequence

In the Setup menu, you can configure whether:

- Calibration is always followed automatically by adjustment ($1\ 10\ 1$; factory setting), or
- You have the choice of ending the sequence or starting adjustment after calibration ($1\ 10\ 2$)

If no difference is determined between nominal and actual weights, you can end the calibration/adjustment routine following calibration.

Two keys are active at this point:

- (CAL) = start calibration/adjustment
- (CF) = end the sequence

isoCAL*:

Automatic Calibration and Adjustment

The menu code setting \uparrow 15 \downarrow must be selected in the Setup menu.

- Temperature range with isoCAL:
0°C to +40°C
The "AUTOCAL" display automatically begins flashing if the ambient temperature has changed in relation to the temperature at the time of the last calibration/adjustment, or after a defined time interval has elapsed. The balance is telling you that it wants to self-calibrate and adjust.

This adjustment prompt is activated when:

- The change in temperature or the elapsed time interval is greater than that shown in the table below
- The load on the pan has not been changed within the last 2 minutes
- The balance has not been operated within the last 2 minutes
- The weight on the pan is no more than 2% of the maximum capacity of the balance

*= CPA64-WDS models:
factory setting isoCAL off (Code \uparrow 15 \downarrow)

When these requirements are met, the following symbols are displayed:

- \square in the measured value line
- AUTOCAL flashes in the symbol display

In the Setup menu, you can configure the balance to display the adjustment prompt only, without performing calibration/adjustment automatically (menu code \uparrow 15 \downarrow).



Important note for calibration/adjustment of the CPA2P-F model: position the cover before calibration/adjustment. This is necessary to enable automatic calibration (isoCAL) to take place.

isoCAL Deactivated on Verified Balances:

The permitted operating temperature range for balances used in applications subject to legal metrology (legal for trade) is restricted as follows:

- Balances of accuracy class \textcircled{I} :
+15°C to 25°C (+59 to +77°F)
- Balances of accuracy class \textcircled{II} :
+10°C to +30°C (+50 to 86°F)

Fully automatic adjustment is initiated under the following conditions:

Model	When the temperature changes by	After a time interval of
CPA2P, CPA2P-F, CPA26P, CPA225D, CPA324S, CPA224S, CPA124S, CPA64, CPA1003S, CPA1003P, GCA1603, GCA803	1.5 Kelvin	4 hours
CPA623S, CPA423S, CPA6202S, CPA5202S-DS, CPA6202P, CPA4202S, CPA523S-PCE, GPA5202, GPA3202	2 Kelvin	6 hours
CPA323S, CPA2202S..., CPA34001P, CPA34001S, CPA223S, CPA3202S, GCA2502	4 Kelvin	12 hours
CPA5201, CPA2201-OCE, CPA10001, CPA16001S, CPA12001S, CPA34000, CPA8201	4 Kelvin	24 hours

These values are also set in the corresponding verified balances (CPA...-OCE/-PCE models with the -OCE designation).

Internal Calibration

Step	Key (or instruction)	Display
1. Zero the balance. CPA2P-F model: Either position the standard pan (8 g) or the filter pan (5 g) along with the cover (3 g) beforehand.	(TARE)	0.0 g
2. Start calibration. The internal weight is applied automatically.	(CAL)	┌ CAL
3. The balance is calibrated (displayed only if menu code 1 10 2 is set).		- 0.2 g CAL ± ▲
4. If the “Calibrate, then auto adjust” setting is selected (1 10 1), the balance is now adjusted automatically.		Adjust* CAL
5. The calibration sequence is completed.		┌┌ CAL
6. The internal weight is removed.		0.0 g







* = Adjust displayed only if menu item 1 10 2 is selected.

External Calibration

Settings:

Calibration/adjustment mode: External calibration/adjustment (menu code $1\ 9\ 1$)

The weight required for calibration/adjustment is defined in the factory settings (see “Specifications”).

Step	Key (or instruction)	Display
1. Zero the balance.	(TARE)	0.0 g
2. Start calibration.	(CAL)	+ 5000.0 g CAL 
3. Apply the prompted calibration weight (in this example, 5000 g).	 	
4. The balance is calibrated (displayed only if menu code $1\ 10\ 2$ is set).		- 0.2 g CAL ± 
5. If the “Calibrate, then auto adjust” setting is selected ($1\ 10\ 1$), the balance is now adjusted automatically.		ADJUST* CAL
6. The calibration/adjustment sequence is completed.		CC CAL
7. After calibration/adjustment, the weight is displayed with weight unit.		+ 5000.0 g
8. Remove the calibration weight.	 	0.0 g

* ADJUST shown only if menu code $1\ 10\ 2$ is set.

Important note: Afterwards, do not perform internal calibration/adjustment again.

Configuration

Purpose

To adapt the balance to individual requirements by choosing from parameters options in the Setup menu.

Features

To open the Setup menu, switch the balance off and then on again by pressing (⏻). While all segments are lit, press (TARE) briefly.

Scroll upward ↑:

Press (CAL)

Scroll to the right →:

Press (⇨)

Confirm input:

Press (TARE)

Save settings and exit menu:

Press and hold (TARE) (> 2 sec.)

● Printing the Parameter Settings

- At the 3rd menu level (lowest level; see also the next page): Press and hold (⇨) (> 2 sec.).

> Printout (Example)

```
Menu 7 1 1
```

- At the 2nd menu level:
Press and hold (⇨) (> 2 sec.).

> Printout (Example)

```
Menu 7 1 1
```



```
Menu 7 2 1
```

```
Menu 7 3 1
```

- All current menu settings are printed when the 1st menu level (highest level) is displayed: Press and hold (⇨) (> 2 sec.).

Setting the Parameters (Menu Codes)

Example: Adapting the balance to “very unstable” ambient conditions (menu code 1 1 4).

Step	Key (or instruction)	Display
1. Switch off the balance.	(\odot)	
2. Switch the balance on;	(\odot)	
while all segments are displayed:	(TARE) briefly	1
<input type="radio"/> Scroll upward within a menu level; after the last menu code, the first code is displayed again.	(CAL) repeatedly	2 3 4
3. Select menu level 2 (scroll to the right).	($\overline{\text{F}}$)	1 1
4. Select menu level 3 (scroll to the right).	($\overline{\text{F}}$)	1 1 2 °
5. Menu level 3: Scroll until the desired number is shown.	(CAL) repeatedly	1 1 4
6. Confirm change; “o” on display indicates active setting.	(TARE)	1 1 4 °
<input type="radio"/> Return to higher menu level (from the third level).	($\overline{\text{F}}$)	1
<input type="radio"/> Set other codes as desired.	($\overline{\text{F}}$), (CAL)	
7. Save changes and exit the menu or	Press and hold (TARE) (> 2 sec.)	
<input type="radio"/> Exit menu without saving changes.	(\odot)	

Parameter Settings (Overview)

- o Factory setting
- √ User-defined setting

	Menu level 1	Menu level 2	Menu level 3	Factory setting	Menu item	
Setup	1	Weighing	1 1	Adapt filter	1 1 1	Very stable conditions
					1 1 2	o Stable conditions
					1 1 3	Unstable conditions
					1 1 4	Very unstable conditions
			1 2	Application filter	1 2 1	o Final readout
					1 2 2	Filling mode
			1 3	Stability range The stability symbol is displayed when the value is stable within this number of digits.	1 3 1	¼ digit
					1 3 2	½ digit
					1 3 3	1 digit
					1 3 4	o 2 digits
					1 3 5	4 digits
					1 3 6	8 digits*
			1 5	Tare function*	1 5 1	Without stability
					1 5 2	o After stability
			1 6	Auto zero	1 6 1	o On
					1 6 2	Off
			1 7	Weight unit 1	1 7 1	Grams (display: o)*
					1 7 2	o Grams (display: g)
					1 7 3	Kilograms ¹⁾
					1 7 4	Carats
1 7 5	Pounds*					
1 7 6	Ounces*					
1 7 7	Troy ounces*					
1 7 8	Hong Kong taels*					
1 7 9	Singapore taels*					
1 7 10	Taiwanese taels*					
1 7 11	Grains*					
1 7 12	Pennyweights*					
1 7 13	Milligrams ²⁾					
1 7 14	Parts per pound*					
1 7 15	Chinese taels*					
1 7 16	Mommes*					
1 7 17	Austrian carats*					
1 7 18	Tola*					
1 7 19	Baht*					
1 7 20	Mesghal*					
		1 8	see next page			
	2 through 9		see following pages			

* = Not available in balances verified for use in legal metrology

1) = Not available for models with a readability ≤ 0.1 mg

2) = Not available for verified balances of accuracy class E1

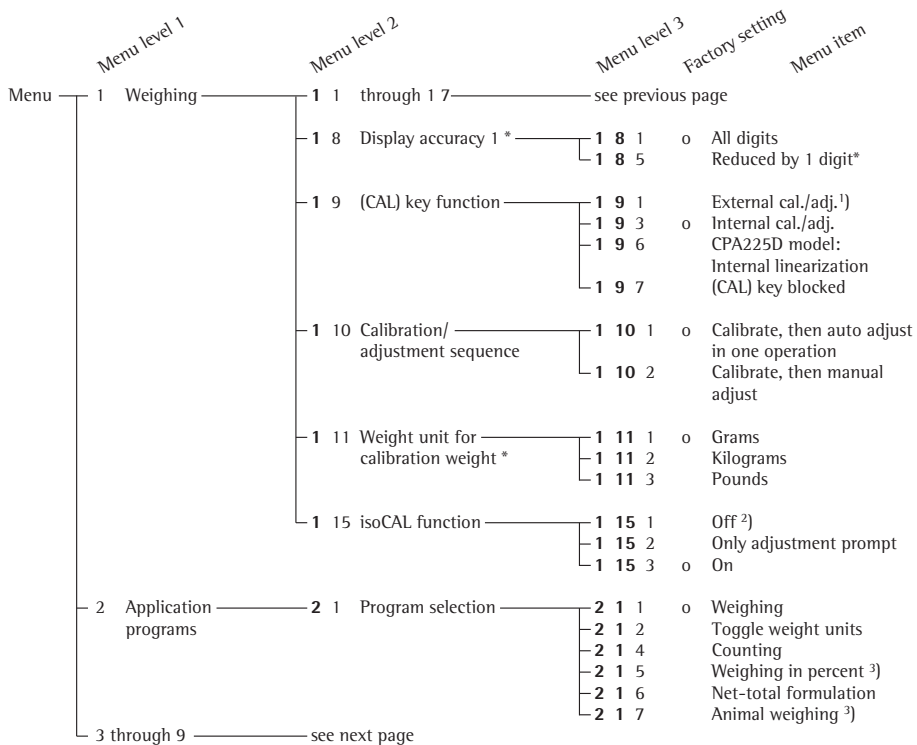

* = Setting cannot be changed on verified balances

¹⁾ = Not available for verified balances of accuracy class **II**

²⁾ = Factory setting for CPA64-WDS

³⁾ = Not available for CPA...-PCE models

Menu	Menu level 1	Menu level 2	Menu level 3	Factory setting	Menu item
1 through 2		see previous page			
3	Application parameters	3 1 Weight unit 2	3 1 1		Grams (display: o)*
			3 1 2	o	Gramm (Anzeige: g)
			3 1 3		Kilograms ¹⁾
			3 1 4		Carats
			3 1 5		Pounds*
			3 1 6		Ounces*
			3 1 7		Troy ounces*
			3 1 8		Hong Kong tael*
			3 1 9		Singapore tael*
			3 1 10		Taiwanese tael*
			3 1 11		Grains*
			3 1 12		Pennyweights*
			3 1 13		Milligrams ²⁾
			3 1 14		Parts per pound*
			3 1 15		Chinese tael*
			3 1 16		Mommes*
			3 1 17		Austrian carats*
			3 1 18		Tola*
			3 1 19		Baht*
			3 1 20		Mesghal*
3 2	Display accuracy 2*	3 2 1	o	All digits	
			3 2 5	o	Reduced by 1 digit
3 5	Storage parameter for Counting and Weighing in Percent	3 5 1		Internal resolution	
			3 5 2	o	Display accuracy with higher stability
3 6	Decimal places for calculations	3 6 1		None	
			3 6 2	o	1 decimal place
			3 6 3		2 decimal places
			3 6 4		3 decimal places
3 7	Animal activity	3 7 1		Calm	
			3 7 2	o	Normal
			3 7 3		Strong vibration
3 8	Start Animal weighing	3 8 1		Manual start	
			3 8 2	o	Automatic start
4	Application parameters Counting	4 1 Autom. reference sample updating	4 1 1	o	Off
				4 1 2	
5 through 9		see next page			

* = Setting cannot be changed on verified balances

¹⁾ = Not available for models with a readability ≤ 0.1 mg

²⁾ = Not available for verified balances of accuracy class II

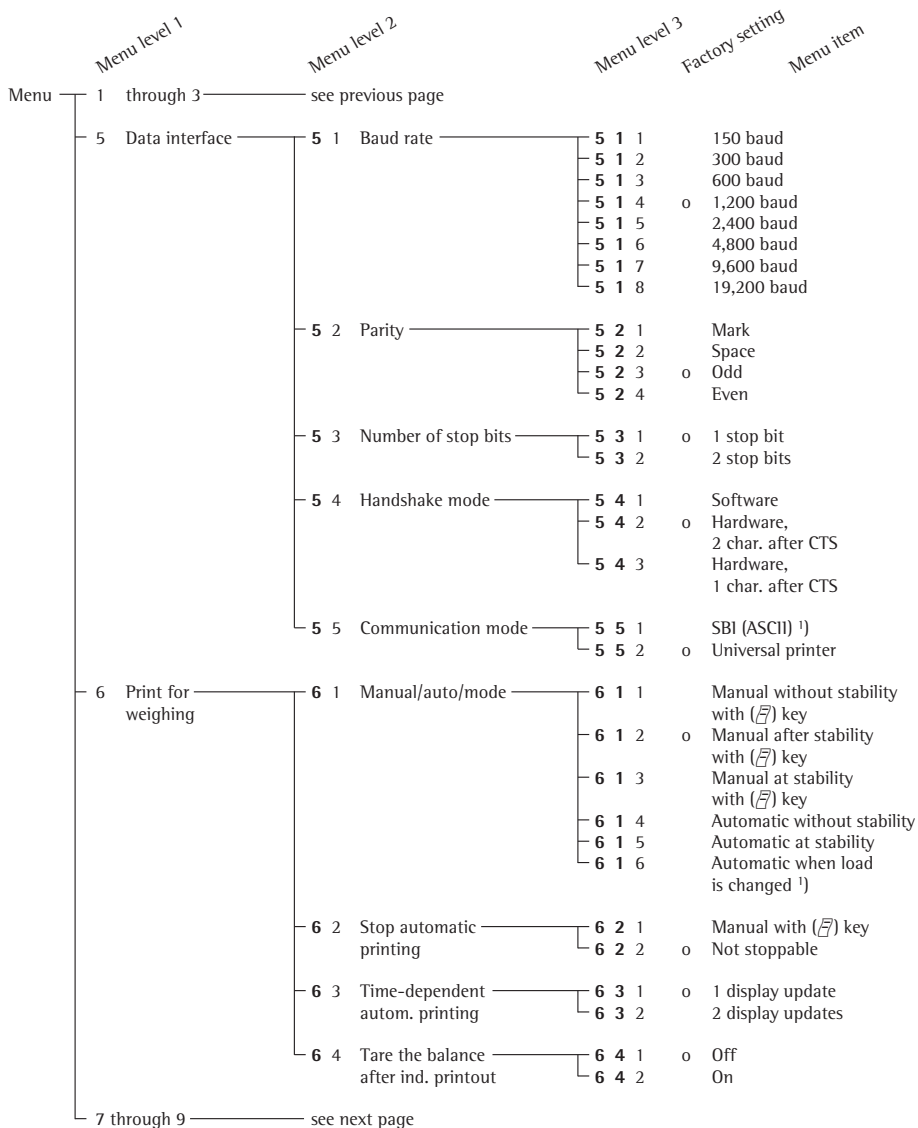

¹⁾ = Note concerning balances verified for legal metrology:

In the "SBI" setting, the non-verified digit indicated is not automatically identified.

Be sure to take the steps or make the settings on the auxiliary device so that these digits are properly identified.

See also the "Interface Port" chapter.

²⁾ = Auto print when load change is > 10 d and stability is reached: no printout until residual difference in load value is < 5 d

Menu	Menu level 1	Menu level 2	Menu level 3	Factory setting	Menu item		
1	through 6	see previous page					
7	Printing with application programs	7 1	Print application parameters	7 1 1	Off		
				7 1 2	On; all parameters		
				7 1 3	On; main parameters only		
		7 2	Line format of printout	7 2 1	For raw data (16 characters)		
				7 2 2	For other apps. (22 characters)		
		7 3	Printout with Net-total program	7 3 1	Autom. printout of last net value		
				7 3 2	Autom. printout of tare value		
		8	Extra functions	8 1	Menu*	8 1 1	Parameter settings alterable
						8 1 2	Parameters "read only"
8 2	Acoustic signal			8 2 1	On		
				8 2 2	Off		
8 3	Keypad			8 3 1	Accessible		
				8 3 2	Blocked		
8 4	External switch function			8 4 1	($\bar{=}$) key		
				8 4 2	(TARE) key		
				8 4 3	(CAL) key		
				8 4 4	(F) key		
		8 4 5	(CF) key				
8 5	Power-on mode for balance	8 5 1	Off/on/standby				
		8 5 3	Standby/on				
		8 5 4	Auto on				
8 8	Reference balance for Counting	8 8 1	Off				
		8 8 2	On for QC scale				
		8 8 3	On for FB /FC /LA /LP balances/scales				
		8 8 4	On for isi terminal				
8 10	ISO/GLP-compliant printout	8 10 1	No ISO/GLP printout				
		8 10 2	For calibration/adjustment only				
		8 10 3	Always on				
9	Reset menu	9 -	Factory settings	9 - 1	Restore		
				9 - 2	Do not restore		

*= Setting cannot be changed on verified balances

Setting IDs, Time, Date and Display Brightness

Purpose

Configuring measurement environment parameters for ISO/GLP-compliant data records.

Setting date and time (for ISO/GLP-compliant records only).

Adapting display to ambient lighting conditions.

Features

- Enter up to 8 characters to identify a measurement series. Permissible characters include the numbers 0 through 9 and the dash or minus sign (“-”). A dash is output as a space on printouts. Leading zeroes are not output.
- Date and time at beginning and end of ISO/GLP-printouts.
- Display brightness 1):
0 = off; levels of brightness: 1 through 9

Key functions during configuration:

Activate input of IDs, time and date:

Switch the balance off and then on again by pressing (⊖); while all segments are displayed, press the (F) key briefly

Scroll upward ↑: Press (CAL)

Scroll to the right →: Press (↷)

Confirm input and toggle between IDs, time and date: Press (TARE)

Save settings and exit menu:

Press and hold (TARE) (> 2 sec.)

- 1) No display backlighting on models CPA2P..., CPA26P(-0CE) and CPA225D(-0CE)

Example: Setting the time, date and display brightness

Step	Key (or instruction)	Display
1. Switch off the balance.	(⏻)	
2. Switch the balance on;	(⏻)	
while all segments are displayed:	(F) briefly	-----
○ To move the cursor within ID number:	(←) repeatedly	-----
○ To set or change ID:	(CAL) repeatedly	-3-----
3. Confirm ID and activate time setting.	(TARE)	H 10. 14. 11
4. Select 24-hour clock (“H”) or 112-hour clock (“P”).	(CAL)	H 10. 14. 19
5. Toggle between hours, minutes, seconds and 12-hour or 24-hour time mode.	(←)	H 10. 15. 19
6. Synchronize seconds with a reference clock.	(CAL)	H 10. 15.00
7. Confirm time and activate date.	(TARE)	29.JAN.01
8. Set date	(CAL) repeatedly,	
“Day,”	(←)	01.JAN.01
“Month,” and,	(CAL) repeatedly	
	(←)	22.APR.01
if desired, “Year.”	(CAL) repeatedly	
Confirm date and activate display brightness.	(TARE)	22.APR.01

Step	Key (or instruction)	Display
9. Set display brightness.	(CAL) repeatedly	LAMP 7
10. Save changes and exit the menu	Press and hold (TARE) (2 sec.)	
or		
○ Exit menu without saving changes.	(⏻)	

Application Programs

Function Keys

(F) key: Start application program/
store component

(F) key Toggle between component
press and weight and total weight
hold for (net-total formulation);
2 seconds change reference quantity
 (counting), reference percentage
 (weighing in percent) or number
 of measurements (animal weighing)

(CF) key: End application program; delete

Using Verified Balances as Legal Measuring Instruments in the EU*:

All application programs can be selected on balances used as legal measuring instruments. Calculated values are alternately indicated with the following symbols:

- Percent = %
- Piece count (Counting) = pcs
- Computed value = 0, Δ

* Including the Signatories of the Agreement on the European Economic Area

Net-total Formulation

Menu code: 2 15 *

Display symbol: ↓

Purpose

With this application program you can weigh in different components up to a defined total.

Features

- Weigh up to 99 components from “0” to a defined total component weight.
- Store component weights (“Store xx comp.”), with
 - display zeroed automatically after value is stored, and
 - automatic printout
- Clear component memory following cancellation of the weighing sequence [by pressing (CF)] and printout of the total weight.
- Toggling between component weight and total weight by pressing and holding (F) (2 sec.).
- Printout of the total of the individual component weights (T COMP)

* = Factory setting on CPA...-PCE models

Preparation

Set parameters for net-total formulation:

- Set parameters for automatic printout when component stored

2 Application programs

2 | Program selection

2 | 6 * Net-total

7 Print for application

7 | Print application parameters

7 | 1 Off

7 | 2 o On; all parameters

7 | 3 On; main parameters only

7 3 Printout of net-total formulation data

7 3 | 1 o Autom. print of last net value

7 3 | 2 Autom. print of tare value

o = Factory setting

* = Factory setting on CPA...-PCE models



Printout of Net-total Formulation Data

COMP2	+	278.1	g:	Second component
T COMP+		2117.5	g:	Sum of components
T1	+	1821.5	g:	Tare weight (2 nd tare memory)
N1	+	278.1	g:	Net weight = Gross - tare 2 nd tare memory
N	+	2099.6	g:	Net weight = Gross - tare

Example: Counting parts into a container

Settings: Application program: Net-total formulation 2 1 6;

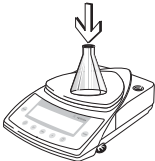
Print application parameters: On, print all 7 1 2; Automatic printout of last net value 7 3 1

Step	Key (or instruction)	Display/Data output
1. Place empty container on the balance.		+ 65.0 g
2. Tare the balance.	(TARE)	0.0 g
3. Add first component.		+ 120.5 g
4. Store component data.	(F)	0.0 g ^{NET} COMP1 + 120.5 g
5. Add next component.		+ 70.5 g
6. Store component data.	(F)	0.0 g ^{NET} COMP2 + 70.5 g
7. Weigh in further components as desired.	Repeat steps 5 and 6.	
8. Continue filling to target (view total).	press and hold (F) (2 sec.)	+ 191.0 g G

Step	Key (or instruction)	Display/Data output
9. Add last component.		+ 203.5 g G
10. Store component data.	(F)	0.0 g _{NET} COMP 3+ 12.5 g
11. Display total weight.	(CF)	+ 203.5 g T COMP+ 203.5 g

Counting

Menu code: 2 14

Display symbol: 

Purpose

With the Counting program you can determine the number of parts that each have approximately equal weight. To do this, a known number of parts (the reference sample quantity) is weighed first, and the individual piece weight (reference weight) is calculated from this result. Thus the number of parts subsequently placed on the balance can be determined from their weight.

Features

- The minimum load is equal to one digit, defined according to the resolution of the active weight unit.
- Press and hold the (F) key (2 seconds) to set the reference sample quantity.
- Configure the resolution used when reference sample quantity is stored and piece counts are calculated.
- Optional automatic output of the piece count and average piece weight to the data interface port when the menu code 7 12 (print application parameters) is set.
- Long-term storage of the last reference sample quantity “nRef” entered.
- Toggling between piece count and weight by pressing (F).

Function Keys

(F):

Begin determination of piece weight

- > Application program initialized with predefined reference sample quantity.

(CF):

End application program; clear initialization data

Changing the reference sample quantity:

- Press and hold (F) (2 sec.)
- > Current reference sample quantity is displayed.
- Press (F) briefly to change the value; press repeatedly until the desired reference sample quantity is displayed. Quantities to choose from: 1, 2, 5, 10, 20, 50, 100.
- Store setting in long-term memory: Press and hold (F).

Reference Sample Updating

Automatic reference sample updating optimizes the counting accuracy. You can activate or deactivate this function in the Setup menu.

When this function is active, automatic reference sample updating is performed when the criteria of the factory-set parameters are met.

- > The abbreviation $\square PE$, for “optimizing,” is displayed briefly with the new reference sample quantity.

Reference Balance/Scale

(Counting with two balances/scales)

Purpose:

Use of a reference balance/scale affords higher precision in counting large amounts of parts. The CPA balance is used to determine the reference weight. The following weighing instruments or terminals can be used for sample weighing in conjunction with a reference balance/scale:

- For a QC scale: set menu code $\text{B B } \varnothing$
- For an FB/FC/LA/LP balance/scale: set menu code $\text{B B } \exists$
- For an isi terminal: set menu code $\text{B B } 4$

- Please order the required connecting cables directly from Sartorius.

The following settings must have the same configurations in both balances/scales:

- Counting program
- Weight units
- Settings in the CPA balance: Menu codes $7 \ 1 \ \varnothing$ and $7 \ \varnothing \ \varnothing$
- All data interface parameters:
 - Baud rate
 - Parity
 - Number of stop bits
 - Handshake mode

Transferring the Reference Value from the CPA Reference Balance:

- Press the (F) key
- > The reference value is passed to the counting balance/scale

Counting Balance/Scale:

- Refer to the operating manual of the particular weighing instrument for further instructions

Preparation

Set parameters for the Counting program:

- Select the application program in the Setup menu
- Set the following parameters:

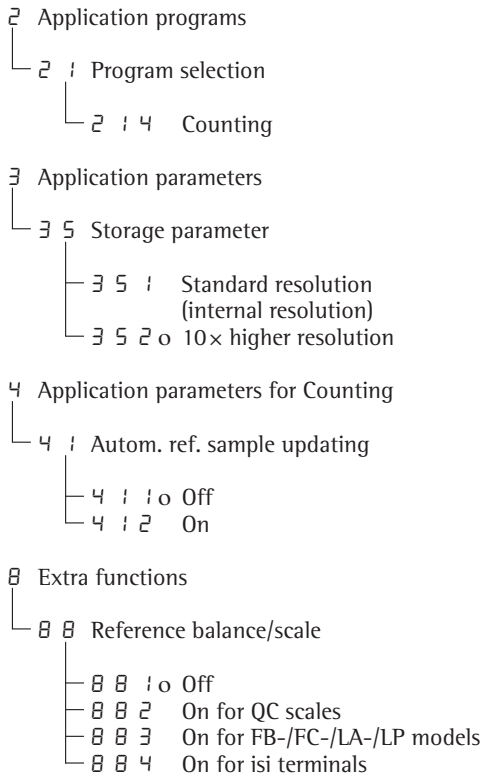

o = Factory setting

Printout: Counting

nRef	+	10	:	Reference sample quantity
wRef	+	21.14 g	:	Reference weight
Qnt	+	500 pcs	:	Calculated quantity

Example: Counting parts of equal weight

Settings:

Menu: Counting program (menu code 2 1 4)

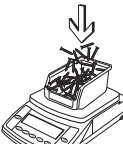
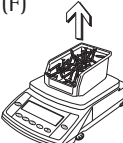
Step	Key (or instruction)	Display/Data output
1. Place empty container on the balance/scale.		+ 22.6 g
2. Tare the balance.	(TARE)	0.0 g
3. Add reference sample quantity to container (in this example: 10 pcs).		
4. Initialize the balance.	(F)	rEF 10 (briefly) + 2.14 g + 10 pcs nRef + 10 pcs wRef + 2.14 g
5. Add uncounted parts as desired.		+ 500 pcs
6. Print piece count, if desired.	(P)	Qnt + 500 pcs
7. Display weight.	(F)	+ 1070.0 g
8. Display piece count.	(F)	+ 500 pcs
9. Unload the balance.		- 0 pcs
10. Repeat as necessary, starting from Step 5.		
11. Delete reference sample quantity	(CF)	0.0 g

Weighing in Percent

Menu code: 2 15 *

Display symbol: %

Purpose

This application program allows you to obtain weight readouts in percent which are in proportion to a reference weight.

Features

- The minimum load is equal to one digit, defined according to the resolution of the active weight unit.
- Press and hold the (F) key (2 seconds) to set the reference percentage
- Storage parameter (rounding-off factor) for storing the reference weight to calculate the percentage can be configured.
- Configuration of decimal places displayed with a percentage.
- Optional automatic output of the reference weight "Wxx%" and reference percentage to the data interface port when the menu code 7 12 (print application parameters) is set.
- Long-term storage of the last reference percentage "pRef" entered.
- Toggling between percentage and weight by pressing (F).

Function Keys

(F):

Begin calculation of percentage

- > Current weight value stored as reference weight "Wxx%" to be loaded at initialization.

(CF):

End application program;
clear initialization data

Changing the reference percentage:

- Press and hold (F) (2 sec.)
- > Current reference percentage is displayed.
- Press (F) briefly to change the value; press repeatedly until the desired reference percentage is displayed. Quantities to choose from: 1, 2, 5, 10, 20, 50, 100.
- Store setting in long-term memory: Press and hold (F).

* = not available for CPA...-PCE models

Preparation

Set parameters for the Weighing in Percent program:

- Select the application program in the Setup menu
- Set the following parameters:

2 Application programs

└─ 2 1 Program selection

└─ 2 1 5 Weighing in percent*

3 Application parameters

└─ 3 5 Storage parameter

└─ 3 5 1 0 Standard resolution
(internal resolution)

└─ 3 5 2 10× higher resolution

└─ 3 6 Decimal places for calc.

└─ 3 6 1 None

└─ 3 6 2 0 1 decimal place

└─ 3 6 3 2 decimal places

└─ 3 6 4 3 decimal places

○ = Factory setting

* = Not in CPA...-PCE models

Printout: Weighing in Percent

pRef	+	100	%:
Wxx%	+	111.6	g:
Prc	+	94.7	%:

Reference percentage
Reference weight net xx%
Calculated percentage

Example: Determining residual weight in percent

Settings:

Menu: Weighing in percent program (menu code 2 / 5),

Print application parameters: On; all parameters (menu code 7 / 2),

Reference percentage: REF 100% (Code)

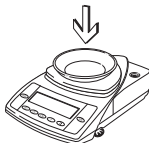
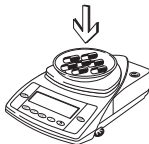
Step	Key (or instruction)	Display/Data output
1. Place empty container on balance		+ 22.6 g
2. Tare the balance.	(TARE)	0.0 g
3. Place sample equal to 100% of reference percentage on the balance (in this example: 111.6 g).		
4. Initialize the balance.	(F)	REF 100 (briefly) + 111.6 g + 100.0 % pRef + 100 % Wxx% + 111.6 g
5. Remove container; e.g., to treat sample (in this example, the sample is now dried).		
6. Place container with sample on the balance again (after treatment).		+ 94.9 %
7. Optional: print percentage.	(F)	PrC + 94.9 %
8. Display residual weight and delete reference value.	(CF)	+ 105.9 g
9. Optional: print net residual weight.	(F)	N + 105.9 g

Animal Weighing/Averaging

Menu code: Code 2 1 7 *



Display symbol: 

Purpose

Use this program to determine the weights of unstable samples (e.g., live animals) or to determine weights under unstable ambient conditions. With this program, the balance calculates the weight as the average of a defined number of individual weighing operations (also referred to as “subweighing operations”).

Features

- Animal weighing started manually or automatically
- Minimum load threshold for starting animal weighing:
 - for automatic start:
100 display intervals
 - for manual start:
50 display intervals
- Automatic start:
Begin the averaging operation by pressing (F). “**AUTO**” is displayed during weighing to indicate that the following values will be averaged automatically.
Animal activity: Averaging begins automatically once two subweights are measured within a predefined tolerance range (calm = 2%, normal = 5%, active = 20%).
- Number of weighing operations for calculation of an average **m d e f** can be set before the beginning of each series.

- Number of remaining weighing operations in the current series is shown during weighing.
- Arithmetic average displayed as a result in the pre-set weight unit (identified by ). The  symbol flashes during this time.
- Toggling between weighed and calculated results by pressing (F) (after initialization)
- Unload threshold is one-half of the minimum load.
- Balance/scale returns to the basic weighing mode when unloaded; i.e., when the load is below the unload threshold

Function Keys

(F):

Activate animal weighing program

(CF):

End application program; delete result; interrupt measuring operation.

Changing the number of subweighing operations:

- Press and hold (F) (2 sec.)
- > Current number of subweighing operations is displayed.
- Press (F) briefly to change the value; press repeatedly until the desired number is displayed.
Quantities to choose from: 5, 10, 20, 50, 100.
- Store setting in long-term memory:
Press and hold (F).

* = not available for CPA...-PCE models

Preparation

Set parameters for the Animal Weighing program:

- Select the application program in the Setup menu
- Set the following parameters:

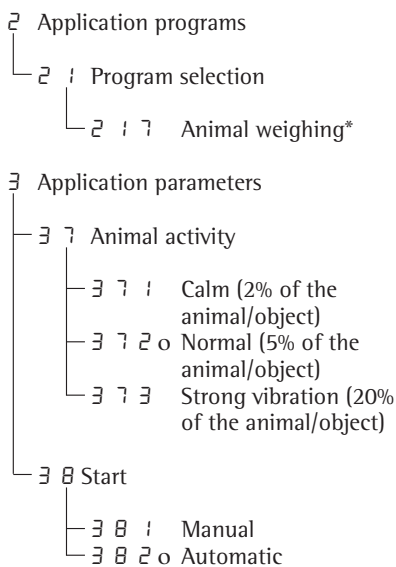

○ = Factory setting

* = Not in CPA...-PCE models

Printout: Animal Weighing

```
mDef          20 :  
x-Net +      401.1 g:
```

Number of subweighing operations
Calculated average

Example: Determining animal weight with automatic start of 20 subweighing operations

Settings:

Menu: Animal weighing program (menu code 2 1 7),

Print application parameters: On; all parameters (menu code 7 1 2)

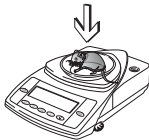
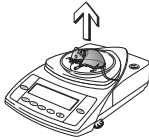
Step	Key (or instruction)	Display/Data output
1. Switch on the balance.	(\odot)	
2. Place animal weighing bowl on the balance.		+ 22.6 g
3. Tare the balance.	(TARE)	0.0 g
4. Place the first animal in bowl.		Weight value fluctuates due to animal activity.
5. Start automatic animal weighing. The balance delays starting the subweighing operation until successive subweights lie within the range defined.	(F)	888 20 19 18 7
6. After 20 subweighing operations the arithmetic average "x-Net" is displayed.		+ 410.1 g Δ mDef 20 x-Net + 410.1 g
7. Unload the balance.		0.0 g
8. Weigh next animal (if applicable).		
Next weighing series begins automatically.		

Toggle between Weight Units

Menu code: 2 1 2

With this application program you can switch the display of a weight value back and forth between two weight units.

Configure the “Toggle Weight Units” application in the Setup menu:
see “Configuration” Menu code: 2. 1. 2
(Factory setting on GCA and GPA models)

Menu code Weight unit 1	Weight unit 2	Unit	Conversion	Display	Print- out
1 7 1	3 1 1 o	Grams ¹⁾	1.00000000000	o	o
1 7 2 o	3 1 2 o	Grams ²⁾	1.00000000000	g	g
1 7 3	3 1 3	Kilograms ³⁾	0.00100000000	kg	kg
1 7 4 o	3 1 4	Carats	5.00000000000	ct	ct
1 7 5	3 1 5	Pounds*	0.00220462260	lb	lb
1 7 6	3 1 6	Ounces*	0.03527396200	oz	oz
1 7 7	3 1 7	Troy ounces*	0.03215074700	ozt	ozt
1 7 8	3 1 8	Hong Kong taels*	0.02671725000	tl	tlh
1 7 9	3 1 9	Singapore taels*	0.02645544638	tl	tls
1 7 10	3 1 10	Taiwanese taels*	0.02666666000	tl	tlt
1 7 11	3 1 11	Grains*	15.4323583500	GN	GN
1 7 12	3 1 12	Pennyweights*	0.64301493100	dwt	dwt
1 7 13	3 1 13 o	Milligrams ⁴⁾	1000.000000000	mg	mg
1 7 14	3 1 14	Parts per pound*	1.12876677120	o	/lb
1 7 15	3 1 15	Chinese taels*	0.02645547175	tl	tlc
1 7 16	3 1 16	Mommes*	0.26670000000	m	mom
1 7 17	3 1 17	Austrian carats*	5.00000000000	K	K
1 7 18	3 1 18	Tola*	0.08573333810	t	tol
1 7 19	3 1 19	Baht*	0.06578947437	b	bat
1 7 20	3 1 20	Mesghal*	0.21700000000	m	MS

o = Factory setting, depends on model

* = Not available in verified balances

¹⁾ = GPA3202: readability with Taiwanese taels reduced by one decimal place

²⁾ = GCA1603P, GCA803S: readability 0.0002 g; GCA2502: readability 0.001 g

³⁾ = Not available in the CPA64-OCE

⁴⁾ = Not available in verified balances/scales of accuracy class E1

Function

- Press (F) to toggle between weight unit 1 and weight unit 2

Generating a Printout

Purpose

You can generate printouts that include weights, other measured values and identification codes for documentation purposes. You can format the printout to meet individual requirements.

Features

Printouts generated automatically or manually (at the press of a key): weight or calculated value is output.

Line format: Values printed with up to 6 preceding characters for identification.

Print application parameters: Printout of initialization values before printing measurement results.

ISO/GLP-compliant printout: Printout of ambient characteristics.

Printouts generated automatically or by pressing ($\overline{\text{F}}$), dependent on or independent of stability.

You can have the following values output automatically when using the application programs if menu code 7 1 2 is configured (printout with data ID codes):

- Net-total: Component or total weight
- Counting:
 - Reference sample quantity (nRef)
 - Reference weight for one piece (wRef)
- Weighing in percent:
 - Reference percentage (pRef)
 - Reference weight (Wxx%)
- Animal weighing/averaging:
 - Number of subweighing operations (mDef)
 - Calculated average (x-Net)

Factory settings:

Print manual/automatic: Individual printout dependent on stability:
Manual at stability (menu code: 5 1 2)

Line format:

Up to 6 characters at the beginning of each line to identify the weight or calculated value: Print net, tare, or gross value, reference sample quantity, or average piece weight with ID (menu code 7 2 2).

Print application parameters:

Printout of one or more initialization values for the active application program: On (menu code 7 1 2)

ISO/GLP-compliant printout:

No ISO/GLP-compliant printout (menu code 8 1 1)

Auto print:

Automatic printout of weight values: No default setting; see print manual/automatic (menu code 5 1 2)

Auto print cannot be interrupted by pressing ($\overline{\text{F}}$) (menu code 5 2 2).

Auto print after each display update (menu code 5 3 1)

- Setting menu codes for the printout: see "Configuration"

Printout without Data ID Codes: Examples

The value currently displayed is printed (weight or calculated value with unit)

	+	1530.0	g
	+	58.562	oz t
	+	253	pcs
	+	88.2	%

Weight in grams
Weight in Troy ounces
Piece count
Percentage

Printout with Data ID Codes:

The current value displayed can be printed with a data ID code of up to 6 characters at the beginning of the line.

ID		12345678	
N	+	153.0	g
T1	+	23.4	g
Qnt	+	253	pcs
Prc	+	88.23	%

Identification*
Current net weight
Value in 2nd tare memory
Piece count
Percentage
* = on ISO/GLP records only

Print Application Parameters:

You can generate a print-out of one or more of the values configured for initialization of an application as soon as you initialize the balance/scale.

Comp7	+	278.1	g
T COMP	+	21.14	g
nRef	+	10	
wRef	+	21.14	g
Wxx%	+	1200.0	g

Net-total:
7th component weight
Net-total: Total
Counting: Reference
sample quantity
Counting: Reference weight
Weighing in percent:
Reference weight

Auto Print:

You can have the weight readout printed automatically.

N	+	153.0	g
Stat			
Stat		L	
Stat		H	

Net weight
Display blank
Display underload
Display overload

ISO/GLP-compliant Printout/Record

Features

You can have the parameters pertaining to the ambient weighing conditions printed before (GLP header) and after (GLP footer) the values of a weighing series. These parameters include:

GLP header:

- Date
- Time at beginning of measurement
- Balance manufacturer
- Balance model
- Balance serial number
- Software version number
- Identification number of the current sampling operation

GLP footer:

- Date
- Time at end of measurement
- Field for operator signature

The record is output to a Sartorius data printer or a computer.

Settings

- Setting menu codes for the printout (see “Configuration”):

- ISO/GLP-compliant record after calibration/adjustment only: menu code $B \ 13 \ 2$; or ISO/GLP-compliant record always on: menu code $B \ 13 \ 3$

- Line format for printout:
With data ID codes - 22 characters:
menu code $7 \ 2 \ 2$

⚠ No ISO/GLP-compliant record is output if any of the following settings are configured: menu code $B \ 1 \ 4$, $B \ 1 \ 5$, $B \ 1 \ 5$ (automatic printout) or $7 \ 2 \ 1$

Function Keys

Press (\overline{F}) to output header and first measured value.

> Header is output the first time (\overline{F}) is pressed

Press (F) to include output header and reference data on automatic printouts when an application program is active

Close the application:

- 1) Output GLP footer:
Press (CF)
- 2) End application program:
Press (CF)

The ISO/GLP-compliant printout can contain the following lines:

-----			Dotted line
17-Jan-2007	10:15		Date/time (beginning of measurement)
SARTORIUS AG			Balance manufacturer
Mod.	CPA10001		Balance model
Ser. no.	10105355		Balance serial number
Ver. no.	00-13-47		Software version
ID	2690 923		ID
-----			Dotted line
L ID			Measurement series no.
nRef +	10 pcs		Counting: Reference sample quantity
wRef +	21.14 g		Counting: Reference weight
Qnt +	235 pcs		Counting result
Qnt +	567 pcs		Counting result
-----			Dotted line
17-Jan-2007	10:20		Date/time (end of measurement)
Name:			Field for operator signature
			Blank line
-----			Dotted line

ISO/GLP-compliant printout for external calibration/adjustment:

-----			Dotted line
17-Jan-2007	10:30		Date/time (beginning of measurement)
SARTORIUS AG			Balance manufacturer
Mod.	CPA10001		Balance model
Ser. no.	10105355		Balance serial number
Ver. no.	00-13-47		Software version
ID	2690 923		ID
-----			Dotted line
Cal. Ext.			Calibration/adjustment mode
Set +	5000.0 g		Calibration weight
Diff. +	0.2 g		Difference determined in calibration
Cal. Ext. Complete			Confirmation of completed calibration procedure
Diff. +	0.0 g		Difference from target following adjustment
-----			Dotted line
17-Jan-2007	10:32		Date/time (end of measurement)
Name:			Field for operator signature
			Blank line
-----			Dotted line

Interface Port

Purpose

Your balance is equipped with an interface port for connection to a computer or other peripheral device.

You can connect a computer to change, start and/or monitor the functions of the balance and the application programs.

Features

Type of interface: Serial interface

Operating mode: Full duplex

Standard: RS-232

Transmission rates:

150, 300, 600, 1200, 2400, 4800, 9600 and 19,200 baud

Parity: Mark, space, odd, even

Character format:

1 start bit, 7-bit ASCII, parity, 1 or 2 stop bits

Handshake:

2-wire interface:

via software (XON/XOFF)

4-wire interface:

Hardware via handshake lines (CTS/DTR)

Operating mode: SBI

Data output format of the balance:

16 or 22 characters

Factory settings:

Transmission rate: 1200 baud (5 1 4)

Parity: Odd (5 2 3)

Stop bits: 1 stop bit (5 3 1)

Handshake: Hardware, 2 characters after CTS (5 4 2)

Operating mode:

Standard Sartorius interface SBI (5 5 1)

Print manually/automatically:

Manual after stability (5 1 2)

Preparation

- see "Pin Assignments" and "Pin Assignment Chart"

Identification of Non-Verified Digits

Non-verified digits when "e#d" are automatically identified on the printout:

Select universal printer:
menu code 5 5 2.

Brackets are used to identify non-verified digits.

Output Format with 16 Characters

Display segments that are not activated are output as spaces.

The following characters can be output, depending on the characters displayed on the balance:

Normal Operation

Position	1	2	3	4	5	6	7	8	9	10	11	12	13	14	15	16
	+				D	D	D	D	D	D	*	U	U	U	CR	LF
or	-		*	*	*		
or	*	*	*	*	*	*	*	*	*	*						

*: Space
 D: Digit or letter
 U: Unit symbol
 CR: Carriage return
 LF: Line feed

Special Codes

Position	1	2	3	4	5	6	7	8	9	10	11	12	13	14	15	16
					*	*	*	*	*	*	*	*	*	*	CR	LF
or							H	*								
or							L	*								
or							C	*								

*: Space
 C: Calibration/adjustment
 H: Overload
 L: Underload

Error Codes

Position	1	2	3	4	5	6	7	8	9	10	11	12	13	14	15	16
				E	r	r	*	#	#	#	*	*	*	*	CR	LF

*: Space
 # # #: Error code number

Data output example: +123.56 g

Position	1	2	3	4	5	6	7	8	9	10	11	12	13	14	15	16
	+				1	2	3	.	5	6		g			CR	LF
	+			1	2	3	.	5	[6]*	g			CR	LF

- Position 1: Plus or minus sign or space
- Position 2: Space or brackets*
- Positions 3–10: Weight with a decimal point; leading zeros = space
- Position 11: Space or brackets*
- Positions 12–14: Unit symbol or space
- Position 15: Carriage return
- Position 16: Line feed

Output Format with 22 Characters

When data is output with an ID code, the ID code (consisting of 6 characters) precedes the 16-character string described above.

These 6 characters identify the subsequent value.

1	2	3	4	5	6	7	8	9	10	11	12	13	14	15	16	17	18	19	20	21	22
I	I	I	I	I	I	+	*	D	D	D	D	D	D	D	D	*	U	U	U	CR	LF
	*	*	*	*	*	-	*	*	*			
						*	*	*	*	*	*	*	*	*	*						

- I: ID code character
- *: Space
- D: Digit or letter
- U: Unit symbol¹⁾
- CR: Carriage return
- LF: Line feed

Example:

1	2	3	4	5	6	7	8	9	10	11	12	13	14	15	16	17	18	19	20	21	22
N						+			1	2	3	.	5	6		g				CR	LF
N						+			1	2	3	.	5	[6]	g			CR	LF

¹⁾ Depends on balance type; for example, not all units or characters are available on balances verified for use in legal metrology.

***) Identification of non-verified digits:**

Non-verified digits where e≠d are identified by brackets (square) if you select the following setting:
 Parameter settings: Communication mode: Universal printer (menu code 5 5 2); "SBI" menu setting
 In the "SBI" setting (menu code 5 5 1), non-verified digits displayed are not automatically identified as such.
 Be sure to take the steps or make the settings on the auxiliary device for this purpose.

Special Codes

1	2	3	4	5	6	7	8	9	10	11	12	13	14	15	16	17	18	19	20	21	22		
S	t	a	t	*	*	*	*	*	*	*	*	*	*	*	*	*	*	*	*	*	CR	LF	
												H	*										
												L	*										

*: Space

H: Overload
L: Underload

Error Codes

1	2	3	4	5	6	7	8	9	10	11	12	13	14	15	16	17	18	19	20	21	22
S	t	a	t	*	*	*	*	*	E	r	r	*	#	#	#	*	*	*	*	CR	LF

*: Space

#: Error code number

ID code characters	Meaning
S t a t	Status
T 1	Tare T1
N	Net N
N 1	Net N1
COMPxx	Net-total: Component no.
T COMP	Net-total: Total weighed in
Q n t	Counting: Quantity
w R e f	Counting: Reference weight
n R e f	Counting: Reference sample quantity
P r c	Weighing in percent: Percentage
W x x %	Weighing in percent: Reference weight
p R e f	Weighing in percent: Reference percentage
m D e f	Animal weighing: No. of measurements remaining
x - N e t	Animal weighing: Calculated average

Data Input Format

You can connect a computer to your balance to send commands via the balance interface port to control balance functions and applications.

The commands sent are control commands and may have different formats.

Each character must be transmitted according to the settings configured in the operating menu for data transmission.

Format for Control Commands

Format 1:	Esc	!	CR	LF
-----------	-----	---	----	----

Format 2:	Esc	!	#	_	CR	LF
-----------	-----	---	---	---	----	----

Esc: Escape	CR: Carriage return (optional)	! #: Letters (characters) and numbers
!: Command character	LF: Line feed (optional)	_: Underline

Command character	Format 1:
	Meaning
!	
K	Weighing mode 1 (very stable conditions)
L	Weighing mode 2 (stable conditions)
M	Weighing mode 3 (unstable conditions)
N	Weighing mode 4 (very unstable conditions)
O	Block keys
P	() key (print, auto print; activate or block)
R	Unblock keys
S	Restart/self-test
T	(TARE) key
Z	Internal calibration/adjustment

Command character	Format 2:
	Meaning
!#	
f0	Function key (F)
f1	Function key (CAL)
s3	(CF) key
x0	Perform internal calibration
x1	Print balance mode
x2	Print weigh cell serial number

Synchronization

During data communication between the balance and a connected device (computer), messages consisting of ASCII characters are transmitted via the interface. For error-free data communication, the parameters for baud rate, parity, handshake mode and character format must be the same for both units.

You can set these parameters in the Setup menu so that they match those of the connected device. You can also define parameters in the balance to make data output dependent on various conditions. The conditions that can be configured are listed in the descriptions of the application programs.

If you do not connect a peripheral device to the balance interface port, this will not generate an error message.

Handshake

The balance interface (Sartorius Balance Interface = SBI) has transmit and receive buffers. You can define the handshake parameter in the Setup menu:

- Hardware handshake (CTS/DTR)
- Software handshake (XON, XOFF)

Hardware Handshake

With a 4-wire interface, 1 more character can be transmitted after CTS (Clear to Send).

Software Handshake

The software handshake is controlled via XON and XOFF. When a device is switched on, XON must be transmitted to enable any connected device to communicate.

If you select the auto print setting, data will be transmitted immediately the moment you turn on the balance. In the operating menu, you can define whether automatic printing can be stopped by pressing (\overline{P}).

Data Output by Print Command

The print command can be transmitted by pressing (\overline{P}) or by a software command (Esc P).

Faster Output Speeds

If you require output speeds faster than 10 Hz, please contact Sartorius for information.

Automatic Data Output

In the “auto print” operating mode, data is output to the interface port without a print command. You can have data output automatically at defined print intervals, with or without the stability parameter. The length of a print interval depends on the settings for “Adapting the filter” (1 1 x) and “Time-dependent automatic printing” (6 3 x).

Pin Assignment Charts

Female Interface Connector:

25-contact D-Submini (DB25S) with screw lock hardware

Male connector used (please use connectors with the same specifications):

25-pin D-Submini DB25S with integrated shielded cable clamp assembly (Amp 826 985-1C) and fastening screws (Amp 164 868-1)

⚠ Warning When Using Pre-wired RS-232 Connecting Cables:

RS-232 cables purchased from other manufacturers often have incorrect pin assignments for use with Sartorius weighing systems. Be sure to check the pin assignments against the chart below before connecting the cable, and disconnect any lines identified differently from those specified by Sartorius (e.g., pin 6).

Failure to do so may damage or even completely ruin your weighing system and/or peripheral device.

Pin Assignment Chart:

Pin 1:	Signal ground
Pin 2:	Data output (TxD)
Pin 3:	Data input (RxD)
Pin 4:	Internal ground (GND)
Pin 5:	Clear to send (CTS)
Pin 6:	Internally connected
Pin 7:	Internal ground (GND)
Pin 8:	Internal ground (GND)
Pin 9:	Reset _ In*)
Pin 10:	Not connected
Pin 11:	+ 12 V
Pin 12:	Reset _ Out *)
Pin 13:	+ 5 V
Pin 14:	Internal ground (GND)
Pin 15:	Universal remote switch
Pin 16:	Not connected
Pin 17:	Not connected
Pin 18:	Not connected
Pin 19:	Not connected
Pin 20:	Data terminal ready (DTR)
Pin 21:	Ground input for external voltage supply
Pin 22:	Not connected
Pin 23:	Not connected
Pin 24:	Ext. supply voltage input +12 to 30 V
Pin 25:	+5 V

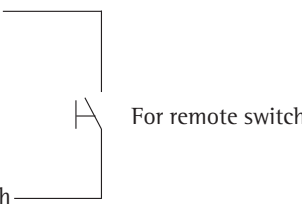

*) = Hardware restart

Cabling Diagram

- For connecting a computer or other peripheral device to the balance using the RS-232C/V24 protocol and cables up to 15 m (50 ft.) long.

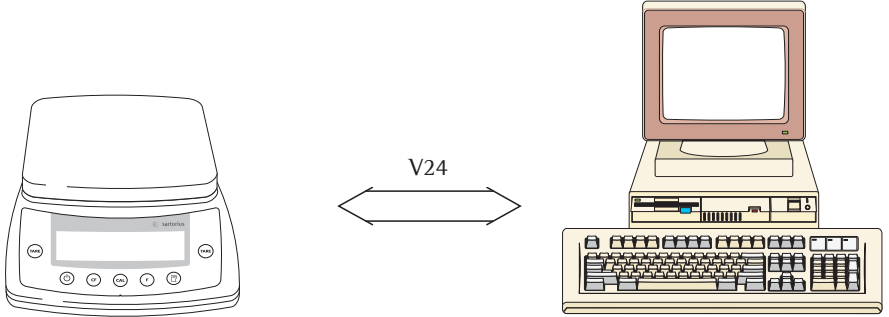

Balance (female connector)

**Peripheral device
(male connector)**

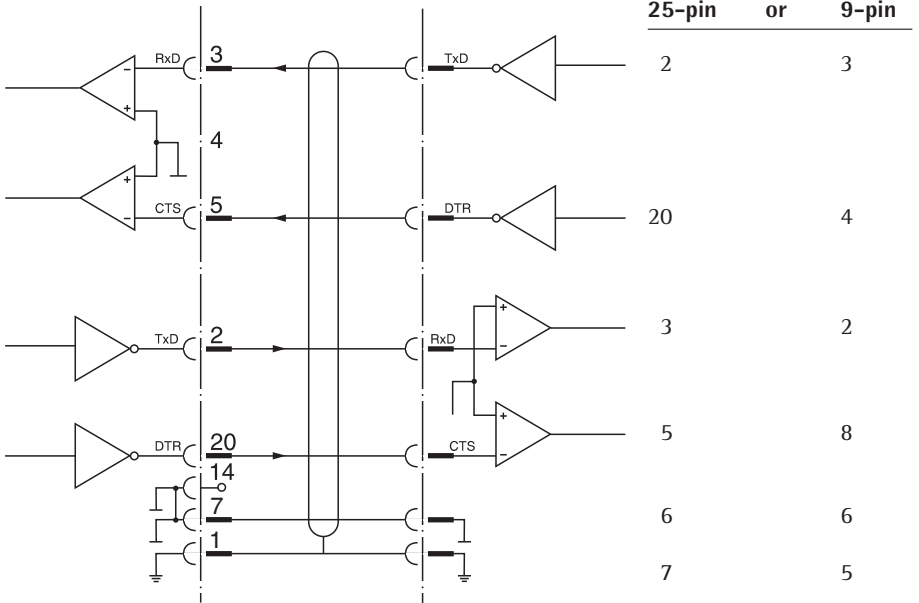

Cable type: AWG 24 specification

Troubleshooting Guide

Error codes are shown on the main display for 2 seconds. The program then returns automatically to the previous mode (e.g., weighing).

Display	Cause	Solution
No segments appear on the display	No AC power is available The power supply is not plugged in	Check the AC power supply Plug in the power supply
H	The load exceeds the balance capacity	Unload the balance
L or Err 54	Something is touching the weighing pan CPA2P-F model: calibration/adjustment not possible without cover	Move the object that is touching the weighing pan To calibrate/adjust, position either the standard pan (8 g) or the filter pan (5 g) along with the cover (3 g)
Err 01	Display overrun (data output incompatible with output format)	Change the configuration in the operating menu
Err 02	Calibration parameter not met; e.g.: – balance not zeroed – load on weighing pan	Calibrate only when zero is displayed – Press (TARE) to zero the balance – Unload the balance
Err 10	The tare keys are blocked when there is data in the second tare memory (net-total); only 1 tare function can be used at a time	Press (CF) to clear the tare memory and release the tare keys
Err 11	Tare memory not allowed	Press (TARE)
Err 22	Weight is too light or, when using an application program, there is no sample on the balance	Increase the weight on the balance
Err 30	Interface port for printer output is blocked	Reset the menu factory settings, or Contact your local Sartorius Service Center
Err 235 on CPA26P, CPA225D	Connecting cable not correctly plugged in Electronics unit of a different balance used	Plug in the cable correctly Connect the units that belong to one another

Display	Cause	Solution
The weight readout changes constantly	Unstable ambient conditions (excessive vibration or draft) at the place of installation	Set up the balance in another area
	A foreign object is caught between weighing pan and balance housing	Remove the foreign object
The weight readout is obviously wrong	The balance was not calibrated/adjusted before weighing	Calibrate/adjust the balance
	The balance was not zeroed before weighing	Zero the balance before weighing

If any other errors occur, contact your local Sartorius Service Center!

Contact information: Please point your Internet browser to: <http://www.sartorius.com>

Preparing CPA2P.. Models for Transport

Model CPA2P:

- Remove the weighing pan
- Remove the interior draft shield from the chamber:
Use your fingers to raise the draft shield carefully until it is free
- Place these parts in the accessory kit
- Fasten the chamber doors by placing a rubber band around the door handles.

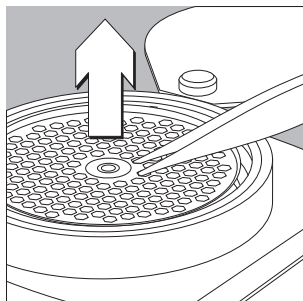

Model CPA2P-F:

- Remove the filter pan cover from the chamber
- Use forceps to remove the filter weighing pan carefully from the chamber
- Remove the interior draft shield from the chamber:
Use your fingers to raise the draft shield carefully until it is free
- Place these parts either in the accessory kit or in the original packaging

The balance/scale must be acclimated again any time it is set up in a new location (see "Installation" chapter).

Care and Maintenance

Service

On request, Sartorius can offer you an individual service contract.

Repairs

Repair work must be performed by trained service technicians. Any attempt by untrained persons to perform repairs may lead to hazards for the user.

Cleaning

- Unplug the AC adapter from the wall outlet (mains supply). If you have an interface cable connected to the balance port, unplug it from the port.
 - Clean the balance using a piece of cloth which has been wet with a mild detergent (soap).
 - After cleaning, wipe down the balance with a soft, dry cloth.
- ⚠ Make sure that no liquid or other foreign objects or dust (powder) enters the balance housing.
- ⚠ Do not use any aggressive cleaning agents (solvents or similar agents).

Cleaning Stainless Steel Surfaces

Clean all stainless steel parts regularly. Remove the stainless steel weighing pan and thoroughly clean it separately. Use a damp cloth or sponge to clean any stainless steel parts on the balance by wiping them down. You can use any commercially available household cleaning agent that is suitable for use on stainless steel. Then wipe down the equipment to rinse thoroughly, making sure to remove all residues. Afterwards, allow the balance to dry. If desired, you can apply oil to the cleaned surfaces as additional protection.

Solvents are permitted for use only on stainless steel parts.

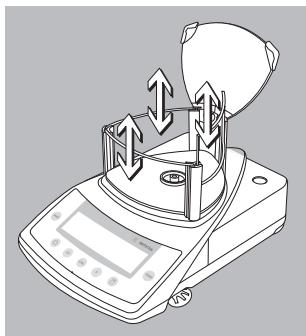

Cleaning the Weighing Chamber and Draft Shield

- Open the draft shield cover and take out the removable parts.
- Use a hand-held vacuum cleaner and mini-hose to remove any powdered sample material carefully.
- Use blotting paper to remove any liquid sample material.
- On models with a 3-sided draft shield, pull the 3 draft shield walls upwards to remove, if necessary.

Safety Inspection

If there is any indication that safe operation of the balance is no longer warranted:

- Turn off the power and disconnect the equipment from AC power immediately.
- > Lock the equipment in a secure place to ensure that it cannot be used for the time being.

Notify your nearest Sartorius Service Center.

Repair work must be performed by trained service technicians.

We recommend having the power supply inspected by a certified electrician at regular intervals, according to the checklist given below:

- Insulating resistance: > 7 megaohms measured with a constant voltage of at least 500 volts at a 500 K-ohm load
- Leakage current: < 0.05mA measured with a properly calibrated multimeter

Instructions for Recycling

Information and Instructions on Disposal and Repairs

Packaging that is no longer required must be disposed of at the local waste disposal facility. The packaging is made of environmentally friendly materials that can be used as secondary raw materials.



The equipment, including accessories and batteries, does not belong in your regular household waste.

The EU legislation requires its Member States to collect electrical and electronic equipment and dispose of it separately from other unsorted municipal waste with the aim of recycling it.

In Germany and many other countries, Sartorius AG takes care of the return and legally compliant disposal of its electrical and electronic equipment on its own. These products may not be placed in household waste or brought to collection centers run by local public disposal operations – not even by small commercial operators.

For disposal in Germany and in the other Member States of the European Economic Area (EEA), please contact our service technicians on location or our Service Center in Goettingen, Germany:

Sartorius AG
Service Center
Weender Landstrasse 94–108
37075 Goettingen, Germany

In countries that are not members of the European Economic Area (EEA) or where no Sartorius affiliates, subsidiaries, dealers or distributors are located, please contact your local authorities or a commercial disposal operator.

Prior to disposal and/or scrapping of the equipment, any batteries should be removed and disposed of in local collection boxes.

Sartorius AG, its affiliates, subsidiaries, dealers and distributors will not take back equipment contaminated with hazardous materials (ABC contamination) – either for repair or disposal. Please refer to the accompanying leaflet/manual or visit our Internet website (www.sartorius.com) for comprehensive information that includes our service addresses to contact if you plan to send your equipment in for repairs or proper disposal.

Overview

Specifications

Model		CPA2P	CPA2P-F
Electronic weighing range	mg	500/1,000/2,000	500/1,000/2,000
Weighing capacity	mg	approx. 2,000	approx. 2,000
Readability	mg	0.001/0.002/0.005	0.001/0.002/0.005
Tare range (subtractive)	mg	approx. -2,000	approx. -2,000
Repeatability (std. deviation)	≤ ± mg	0.001/0.002/0.003	0.002/0.003/0.004
Linearity	≤ ± mg	0.002/0.004/0.005	0.002/0.004/0.005
Response (average)	s	10	10
Operating temperature range	°C	+15 to +30°C (59°F to 86°F)	
Allowable ambient operating temperature	°C	+5 to +40°C (41°F to 104°F)	
Sensitivity drift within +15... +30°C	≤ ±/K	5 · 10 ⁻⁶	
External calibration weight (of at least accuracy class...)	g	2 (E2)	2 (E2)
Weighing pan diameter	mm	20 Ø	125 Ø or 20 Ø
Dimensions (WxDxH)	mm	213 × 342 × 151	213 × 342 × 115
Weighing chamber (WxDxH)	mm	54 × 49,5 × 55,5	Height: 12
Net weight, approx.	kg	4.35	5.0
AC power source/ Power requirements	V~	AC adapter, 230 V or 115 V, +15%...-20% (protection rating IP20)	
Frequency	Hz	48 – 60	
Power consumption (average)	VA	maximum 16; typical 8	
Approx. hours of operation with the YRB08Z rechargeable battery pack	h	22	22
Selectable weight units		Grams, carats, pounds, ounces, Troy ounces, Hong Kong taels, Singapore taels, Taiwanese taels, grains, pennyweights, milligrams, parts per pound, Chinese taels, mommes, Austrian carats, tola, baht and mesghal	
Built-in interface		RS-232/V24-V28	
Format:		7-bit ASCII, 1 start bit, 1 or 2 stop bits	
Parity:		Mark, odd, even or space	
Transmission rates:		150 to 19,200 baud	
Handshake mode:		Software or hardware	

Model		CPA26P	CPA225D	CPA324S	CPA224S	CPA124S	CPA64	CPA64-WDS
Weighing capacity	g	5/21	40/100/220	320	220	120	64	64
Readability	mg	0.002/0.01	0.01/0.01/0.1	0.1	0.1	0.1	0.1	0.1
Tare range (subtractive)	g	-21	-220	-320	-220	-120	-64	-64
Repeatability (std. deviation)	≤±mg	0.004	0.02/0.05/0.1	0.2	0.1	0.1	0.1	0.1 ¹⁾
Linearity	≤±mg	0.008	0.03/0.1/0.2	0.3	0.2	0.2	0.2	0.2 ¹⁾
Response time (average)	s	10	≤ 6/3	≤ 3	≤ 2	≤ 2	≤ 2	≤ 2 ¹⁾
Operating temperature range	°C	+10 to +30°C (50° to 86°F)						
Allowable ambient operating temperature	°C	+5 to +40°C (41°F to 104°F)						
Sensitivity drift within +10... +30°C	≤±/K	1 · 10 ⁻⁶						
External calibration weight (of at least accuracy class...)	g	20 (E2)	200 (E2)	200 + 100 (E2)	200 (E2)	100 (E2)	50 (E2)	50 (E2)
Net weight, approx.	kg	7.6	7.6	6.5	6.5	6.5	6.5	4.1
Pan size (inner diameter)*	mm	50 Ø	80 Ø	80 Ø	80 Ø	80 Ø	80 Ø	80 Ø
Pan area*	cm ²	20	64	64	64	64	64	64
Weighing chamber height (from pan to cover)	mm	162	232	232	232	232	232	-
Dimensions (W×D×H)								
- Balance	mm	213×342×270	213×342×340		213×342×340		213×342×92	
- Electronics box	mm	134×51×155		-	-	-	-	-
AC power source/ Power requirements	V~	AC adapter, 230 V or 115 V, +15%...-20% (protection rating IP20)						
Frequency	Hz	48 - 60						
Power consumption (average)	VA	maximum 16; typical 8						
Approx. hours of operation with the YRB05Z rechargeable battery pack	h	20	20	22	22	22	22	22
Selectable weight units		Grams, carats, pounds, ounces, Troy ounces, Hong Kong taels, Singapore taels, Taiwanese taels, grains, pennyweights, milligrams, parts per pound, Chinese taels, mommes, Austrian carats, tola, baht and mesghal						
Build-in interface		RS-232/V24-V28						
Format:		7-bit ASCII, 1 start bit, 1 or 2 stop bits						
Parity:		Mark, odd, even or space						
Transmission rates:		150 to 19,200 baud						
Handshake mode:		Software or hardware						



* Three-sided weighing pan: Ø = diameter of inner circle.
The cross-hatched section can be fully utilized.

¹⁾ These specifications were determined with the draft shield in place.

Model		GCA1603P	GCA803S	GCA2502
Weighing capacity	ct	800/1,600	800	2,500 (500 g)
Readability	ct	0.001/0.01	0.001	0.01 ¹⁾
Tare range (subtractive)	ct	-1,600	-800	-2,500
Repeatability (std. deviation)	<± ct	0.001/0.01	0.001	0.01
Linearity	<± ct	0.002	0.001	0.01
Response time (average)	s	< 2		
Operating temperature range	°C	+10.... +30°C (50°F to 86°F)		
Allowable ambient operating temperature	°C	+5.... +40°C (41°F to 104°F)		
Sensitivity drift within +10... +30°C	<±/K	1 · 10 ⁻⁶	1 · 10 ⁻⁶	2 · 10 ⁻⁶
External calibration weight (of at least accuracy class...)	g	200 + 100 (E2)	100 (E2)	200 (F1)
Net weight, approx.	kg	6.1		
Pan size (inner diameter)*	mm	80 Ø	80 Ø	110 Ø
Pan surface*	cm ²	64	64	120
Weighing chamber height (from pan to cover)	mm	162		
Dimensions (WxDxH)	mm	213x342x270		
AC power source/ Power requirements	V~	AC adapter, 230 V or 115 V, +15%...-20% (protection rating IP20)		
Frequency	Hz	48 – 60		
Power consumption (average)	VA	maximum 16; typical 8		
Approx. hours of operation with the YRB08Z rechargeable battery pack	h	22	22	27
Selectable weight units		Grams, carats, pounds, ounces, Troy ounces, Hong Kong tael, Singapore tael, Taiwanese tael, grains, pennyweights, milligrams, parts per pound, Chinese tael, mommes, Austrian carats, tola, baht and mesghal		
Built-in interface		RS-232/V24-V28		
Format:		7-bit ASCII, 1 start bit, 1 or 2 stop bits		
Parity:		Mark, odd, even or space		
Transmission rates:		150 to 19,200 baud		
Handshake mode:		Software or hardware		

¹⁾ For readability 0.005 ct, select menu code 1 8 1 or 3 2 1 (see “Configuring the Balance/Scale”)



* Three-sided weighing pan: Ø = diameter of inner circle.
The cross-hatched section can be fully utilized.

Model		CPA1003S	CPA1003P	CPA623S	CPA423S, CPA423S-DS	CPA323S	CPA223S
Weighing capacity	g	1,000	500/1,010	620	420	320	220
Readability	g	0.001	0.001/0.01	0.001	0.001	0.001	0.001
Tare range (subtractive)	g	-1,000	-1,010	-620	-420	-320	-220
Repeatability (std. deviation)	≤± g	0.001	0.001/0.01	0.001	0.001	0.001	0.001
Linearity	≤± g	0.002	0.002/0.02	0.002	0.002	0.002	0.002
Response time (average)	s	≤ 2	≤ 2	≤ 1.5	≤ 1.5	≤ 1.5	≤ 1.5
Operating temperature range	°C	10° to 30° (50° to 86°F)					
Allowable ambient operating temperature	°C	0° to 40° (32° to 104°F)					
Sensitivity drift within +10 to +30°C	≤±/K	2 · 10 ⁻⁶					
External calibration weight (of at least accuracy class...)	g	1,000 (E2)	1,000 (E2)	500 (E2)	200 (F1)	200 (F1)	200 (F1)
Net weight, approx.	kg	6.5	6.5	4.6	4.6	4.6	4.6
Weighing pan size (inner diameter)*	mm	110 Ø					
Weighing pan area*	cm ²	120					
Weighing chamber height (weighing pan to draft shield cover)	mm	240	240	50	50	50	50
Dimensions (WxDxH)	mm	213×342×340		213× 342×153	213×342×153 CPA423S-DS: 213×342×340		
AC power source/ power requirements	V~	AC adapter STNG6, 230 V or 115 V, +15% to - 20% (protection rating IP20)					
Frequency	Hz	48 – 60					
Power consumption (average)	VA	maximum 16; typical 8					
Approx. hours of operation with the YRB05Z rechargeable battery pack	h	27					
Selectable weight units		Grams, carats, pounds, ounces, Troy ounces, Hong Kong taels, Singapore taels, Taiwanese taels, grains, pennyweights, milligrams, parts per pound, Chinese taels, mommes, Austrian carats, tola, baht and mesghal					
Built-in interface		RS-232C-S/V24-V28; 7-bit; parity: even, odd, mark, or space; transmission rates: 150 to 19,200 baud; 1 or 2 stop bits; software/hardware handshake					



* Three-sided weighing pan: Ø = diameter of inner circle.
The cross-hatched section can be fully utilized.

Model		CPA6202S	CPA6202P	GPA5202/ CPA5202S-DS	CPA4202S	CPA3202S/ GPA3202	CPA2202S/ CPA2202S-DS
Weighing capacity	g	6,200	1,500/ 3,000/6,200	5,200	4,200	3,200	2,200
Readability	g	0.01	0.01/0.02/ 0.05	0.01	0.01	0.01	0.01
Tare range (subtractive)	g	-6,200	-6,200	-5,200	-4,200	-3,200	-2,200
Repeatability (std. deviation)	≤± g	0.01	01/0.01/ 0.03	0.01	0.01	0.01	0.01
Linearity	≤± g	0.02	0.02/0.02/ 0.05	0.02	0.02	0.02	0.02
Response time (average)	s	≤ 1.5					
Operating temperature range	°C	10° to 30° (50° to 86°F)					
Allowable ambient operating temperature	°C	0° to 40° (32° to 104°F)					
Sensitivity drift within +10 to +30°C	≤±/K	2 · 10 ⁻⁶					
External calibration weight (of at least accuracy class...)	g	5,000 (E2)	5,000 (F1)	5,000 (E2)	2,000 (E2)	2,000 (F1)	2,000 (F1)
Net weight, approx.	kg	4.7	4.7	6	4.7	4.7	4.7/6
Weighing pan size	mm	190×204	190×204	∅ 130	190×204	190×204	190×204/ ∅ 130
Weighing pan area	cm ²	388	388	133	388	388	388/133
Dimensions (W×D×H)	mm	213× 342× 88	213× 342× 88	213× 342× 88/340	213× 342× 88	213× 342× 88	213× 342× 88/340
AC power source/ power requirements	V~	AC adapter STNG6, 230 V or 115 V, +15% to - 20% (protection rating IP20)					
Frequency	Hz	48 - 60					
Power consumption (average)	VA	maximum 16; typical 8					
Approx. hours of operation with the YRB05Z rechargeable battery pack	h	27					
Selectable weight units		Grams, kilograms, carats, pounds, ounces, Troy ounces, Hong Kong taels, Singapore taels, Taiwanese taels, grains, pennyweights, milligrams, parts per pound, Chinese taels, mommes, Austrian carats, tola, baht and mesghal					
Built-in interface		RS-232C-S/V24-V28; 7-bit; parity: even, odd, mark, or space; transmission rates: 150 to 19,200 baud; 1 or 2 stop bits; software/hardware handshake					

Model		CPA 10001	CPA 8201	CPA 5201	CPA 34001S	CPA 34001P	CPA 16001S	CPA 12001S	CPA 34000
Weighing capacity	kg	10	8.2	5.2	34	8/16/34	16	12	34
Readability (scale interval)	g	0.1	0.1	0.1	0.1	0.1/0.2/0.5	0.1	0.1	1
Tare range (subtractive)	kg	-10	-8.2	-5.2	-34	-34	-16	-12	-34
Repeatability (std. deviation)	≤±g	0.1	0.1	0.1	0.1	0.1/0.2/0.5	0.1	0.1	1
Linearity	≤±g	0.2	0.2	0.2	0.2	0.3/0.3/0.3	0.2	0.2	0.5
Response time (average)	s	≤ 1	≤ 1	≤ 1	≤ 2	≤ 2	≤ 2	≤ 2	≤ 1.5
Operating temperature range	°C	10° to 30° (50° to 86°F)							
Allowable ambient operating temperature	°C	0° to 40° (32° to 104°F)							
Sensitivity drift within 10° to 30°C	≤±/K	4 · 10 ⁻⁶	4 · 10 ⁻⁶	4 · 10 ⁻⁶	2 · 10 ⁻⁶	2 · 10 ⁻⁶	2 · 10 ⁻⁶	2 · 10 ⁻⁶	2 · 10 ⁻⁶
External calibration weight (of at least accuracy class...)	kg	5 (F1)	5 (F2)	5 (F2)	10 (F1)	10 (F2)	10 (F1)	10 (F1)	10 (F2)
Net weight, approx.	kg	4.7	4.7	4.7	16	16	16	16	16
Weighing pan size	mm	190×204	190×204	300×400		300×400	300×400	300×400	300×400
Dimensions (W×D×H)	mm	213× 342× 90	213× 342× 90	213× 342× 90	313× 532× 120	313× 532× 120	313× 532× 120	313× 532× 120	313× 532× 120
AC power source/ power requirements	V~	AC adapter STNG6, 230 V or 115 V, +15% to -20% (protection rating IP20)							
Frequency	Hz	48 - 60							
Power consumption (average)	VA	maximum 16; typical 8							
Approx. hours of operation with a rechargeable battery pack	h	40	40	40	22	22	22	22	22
Selectable weight units		Grams, kilograms, carats, pounds, ounces, Troy ounces, Hong Kong taels, Singapore taels, Taiwanese taels, grains, pennyweights, milligrams, parts per pound, Chinese taels, mommes, Austrian carats, tola, baht and mesghal							
Cable length between display unit/weighing platform	m	-	-	-	1.2	1.2	1.2	1.2	1.2
Built-in interface		RS-232C-S/V24-V28; 7-bit; parity: even, odd, mark, or space; transmission rates: 150 to 19,200 baud; 1 or 2 stop bits; software/hardware handshake							



* Three-sided weighing pan: Ø = diameter of inner circle.
The cross-hatched section can be fully utilized.

Specifications

Model		CPA26P -OCE	CPA225D -OCE	CPA324S -OCE	CPA224S -OCE, CPA224 -PCE	CPA124S -OCE, CPA124S -PCE	CPA64 -OCE
Type		BC BL 100	BC BL 100	BC BL 100	BC BL 100	BC BL 100	BC BL 100
Accuracy class ¹⁾		Ⓡ	Ⓡ	Ⓡ	Ⓡ	Ⓡ	Ⓡ
Maximum capacity, Max ¹⁾	g	5/21	100/220	320	220	120	64
Scale interval d ¹⁾	mg	0.002/0.01	0.01/0.1	0.1	0.1	0.1	0.1
Tare range (subtractive)	g	≤ 100% of the maximum capacity					
Verification scale interval, e ¹⁾	g	0.001	0.001	0.001	0.001	0.001	0.001
Minimum capacity, Min ¹⁾	g	0.0002	0.001	0.01	0.01	0.01	0.01
Response time (average)	s	10	≤ 6/3	≤ 3	≤ 2	≤ 2	≤ 2
Range of use according to CD ¹⁾	g	0.0002–21	0.001–220	0.01–320	0.01–220	0.01–120	0.01–64
Allowable ambient operating temperature:							
– with “isoCAL” function	°C	+10° to +30° (+50° to +86°F)					
– without “isoCAL” function	°C	+15° to +25° (+59° to +77°F)					
External calibration weight (of at least accuracy class...)	g	20 (E2)	200 (E2)	200 + 100 (E2)	200 (E2)	100 (E2)	50 (E2)
Net weight, approx.	kg	7.6	7.6	6.5	6.5	6.5	6.5
Weighing pan size (inner diameter)	mm	50 ∅	80 ∅*	80 ∅*	80 ∅*	80 ∅*	80 ∅*
Weighing pan area	cm ²	20	64*	64*	64*	64*	64*
Weighing chamber height (weighing pan to draft shield cover)	mm	162	232	232	232	232	232
Dimensions (WxDxH)							
– Balance	mm	213 × 342 × 270	213 × 342 × 340	213 × 342 × 340	213 × 342 × 340	213 × 342 × 340	213 × 342 × 340
– Electronics box	mm	134 × 51 × 155	134 × 51 × 155	–	–	–	–
AC power source/ power requirements	V~	AC adapter STNG6, 230 V or 115 V, +15%...– 20% (protection rating IP20)					
Frequency	Hz	48 – 60					
Power consumption (average)	VA	maximum 16; typical 8					
Approx. hours of operation with the YRB05Z rechargeable battery pack	h	20	20	22	22	22	22
Selectable weight units		Grams, carats, milligrams					
Built-in interface		RS-232C-S/V24-V28; 7-bit; parity: even, odd, mark, or space; transmission rates: 150 to 19,200 baud; 1 or 2 stop bits; software/hardware handshake					

¹⁾ CD= Council Directive 90/384/ECC for non-automatic weighing instruments; applicable to the European Economic Area



* Three-sided weighing pan: ∅ = diameter of inner circle. The cross-hatched section can be fully utilized.

Model		CPA1003S-OCE	CPA623S-OCE	CPA523S-PCE	CPA423S-OCE
Type		BD BL 100	BD BL 200	BD BL 200	BD BL 200
Accuracy class ¹⁾		Ⓡ	Ⓢ	Ⓢ	Ⓢ
Maximum capacity, Max ¹⁾	g	1,000	620	520	420
Scale interval, d ¹⁾	g	0.001	0.001	0.001	0.001
Tare range (subtractive)	g	≤ 100% of the maximum capacity			
Verification scale interval, e ¹⁾	g	0.01	0.01	0.01	0.01
Minimum capacity, Min ¹⁾	g	0.1	0.02	0.02	0.02
Response time (average)	s	≤ 1.5			
Range of use according to CD ¹⁾	g	0.1–1,000	0.02–620	0.02–520	0.02–420
Allowable ambient operating temperature:					
– with “isoCAL” function		+10 to +40°C (+50° to +104°F)	+0° to +40°C (+32° to +104°F)	+0° to +40°C (+32° to +104°F)	+0° to +40°C (+32° to +104°F)
– without “isoCAL” function		+15 to +25°C (+50° to +77°F)	+10° to +30°C (+50° to +86°F)	+10° to +30°C (+50° to +86°F)	+10° to +30°C (+50° to +86°F)
Net weight, approx.	kg	6.5	4.6	4.6	4.6
Weighing pan size (inner diameter)*	mm	110 ∅			
Weighing pan surface*	cm ²	120			
Weighing chamber height (weighing pan to draft shield cover)	mm	240	50	50	50
Dimensions (W×D×H)	mm	213×342×340	213×342×153	213×342×153	213×342×153
AC power source/ power requirements	V~	AC adapter STNG6 230 V or 115 V, +15% to – 20% (protection rating IP20)			
Frequency	Hz	48 – 60			
Power consumption (average)	VA	maximum 16; typical 8			
Approx. hours of operation with the YRB05Z rechargeable battery pack	h	27			
Selectable weight units		Grams, carats			
Built-in interface		RS-232C-S/V24-V28; 7-bit; parity: even, odd, mark, or space; transmission rates: 150 to 19,200 baud; 1 or 2 stop bits; software/hardware handshake			

¹⁾ CD= Council Directive 90/384/ECC for non-automatic weighing instruments; applicable to the European Economic Area



* Three-sided weighing pan: ∅ = diameter of inner circle.
The cross-hatched section can be fully utilized.

Model	CPA323S-OCE	CPA223S-OCE	GC1603S-OCE	GC803S-OCE
Type	BD BL 200	BD BL 200	BC BL 100	BC BL 100
Accuracy class ¹⁾	Ⓜ	Ⓜ	Ⓛ	Ⓛ
Maximum capacity, Max ¹⁾	320 g	220 g	1,600 ct	800 ct
Scale interval, d ¹⁾	0.001 g	0.001 g	0.001 ct	0.001 ct
Tare range (subtractive)	≤ 100% of the maximum capacity			
Verification scale interval, e ¹⁾	0.01 g	0.01 g	10 mct	10 mct
Minimum capacity, Min ¹⁾	0.02 g	0.02 g	0.1 ct	0.1 ct
Response time (average)	s	≤ 1.5	≤ 1.5	≤ 2
Range of use according to CD ¹⁾	0.02–320 g	0.02–220 g	0.1–1,600 ct	0.1–800 ct
Allowable ambient operating temperature:				
– with “isoCAL” function	°C	+10° to +40° (+50° to +104°F)		+15 to +25 (59°F to 77°F)
– without “isoCAL” function	°C	+15° to +25° (+59° to +77°F)		
External calibration weight (of at least accuracy class)	g	200 + 100 (E2)		100 (E2)
Net weight, approx.	kg	4.6	4.6	6.1
Weighing pan size (inner diameter)*	mm	110 ∅	110 ∅	80 ∅
Weighing pan area*	cm ²	120	120	64
Weighing chamber height (weighing pan to draft shield cover)	mm	50	50	162
Dimensions (WxDxH)	mm	213x342x153	213x342x153	213x342x270
AC power source/ power requirements	V~	AC adapter STNG6 230 V or 115 V, +15% to –20% (protection rating IP20)		
Frequency	Hz	48 – 60		
Power consumption (average)	VA	maximum 16; typical 8		
Approx. hours of operation with the YRB05Z rechargeable battery pack	h	27	27	22
Selectable weight units		Grams, carats		Grams, milligrams, carats
Build-in interface		RS-232C-S/V24-V28; 7-bit; parity: even, odd, mark, or space; transmission rates: 150 to 19,200 baud; 1 or 2 stop bits; software/hardware handshake		

¹⁾ CD= Council Directive 90/384/ECC for non-automatic weighing instruments; applicable to the European Economic Area



* Three-sided weighing pan: ∅ = diameter of inner circle.
The cross-hatched section can be fully utilized.

Model		CPA6202S -OCE	CPA6202P -OCE	GPA5202 -OCE	CPA4202S -OCE, CPA4202S -PCE	CPA3202S -OCE, CPA3202S -PCE, GPA3202 -OCE	CPA2202S -OCE
Type		BD BL 200	BD BL 200	BD BL 200	BD BL 200	BD BL 200	BD BL 200
Accuracy class ¹⁾		II	II	II	II	II	II
Maximum capacity, Max ¹⁾	g	6,200	1,500/3,000/ 6,200	5,200	4,200	3,200	2,200
Scale interval, d ¹⁾	g	0.01	0.01/0.02/ 0.05	0.01	0.01	0.01	0.01
Tare range (subtractive)	g	≤ 100% of the maximum capacity					
Verification scale interval, e ¹⁾	g	0.1	0.1	0.1	0.1	0.1	0.1
Minimum capacity, Min ¹⁾	g	0.5	0.5	0.5	0.5	0.5	0.5
Response time (average)	s	≤ 1.5					
Range of use according to CD ¹⁾	g	0.5–6,200	0.5–6,200	0.5–5,200	0.5–4,200	0.5–3,200	0.5–2,200
Allowable ambient operating temperature:							
– with “isoCAL” function	°C	+0° to +40° (+32° to +104°F)					
– without “isoCAL” function	°C	+10° to +30° (+50° to +86°F)					
Net weight, approx.	kg	4.7					
Weighing pan size	mm	190×204					
Weighing pan area*	cm ²	388					
Dimensions (W×D×H)	mm	213×342×88					
AC power source/ power requirements	V~	AC adapter STNG6 230 V or 115 V, +15% to – 20% (protection rating IP20)					
Frequency	Hz	48 – 60					
Power consumption (average)VA		maximum 16; typical 8					
Approx. hours of operation with the YRB05Z rechargeable battery pack	h	27					
Selectable weight units		Grams, kilograms, carats					
Built-in interface		RS-232C-S/V24-V28; 7-bit; parity: even, odd, mark, or space; transmission rates: 150 to 19,200 baud; 1 or 2 stop bits; software/hardware handshake					

¹⁾ CD= Council Directive 90/384/ECC for non-automatic weighing instruments; applicable to the European Economic Area

Model		CPA10001-OCE	CPA8201-OCE	CPA5201-OCE	CPA2201-OCE
Type		BD BL 200	BD BL 200	BD BL 200	BD BL 200
Accuracy class ¹⁾		Ⓜ	Ⓜ	Ⓜ	Ⓜ
Maximum capacity, Max ¹⁾	g	10,000	8,200	5,200	2,200
Scale interval, d ¹⁾	g	0.1	0.1	0.1	0.1
Tare range (subtractive)	g	≤ 100% of the maximum capacity			
Verification scale interval, e ¹⁾	g	1	1	1	0.1
Minimum capacity, Min ¹⁾	g	5	5	5	5
Response time (average)	s	≤ 1			
Range of use according to CD ¹⁾	g	5–10,000	5–8,200	5–5,200	5–2,200
Allowable ambient operating temperature:					
– with “isoCAL” function	°C	0° to +40° (+32° to +104°F)			
– without “isoCAL” function	°C	+10° to +30° (+50° to +86°F)			
Net weight, approx.	kg	4.7			
Weighing pan size	mm	190×204	190×204		
Weighing pan area*	cm ²	388	388		
Dimensions (W×D×H)	mm	213×342×90	213×342×90		
AC power source/ power requirements	V~	AC adapter STNG6 230 V or 115 V, +15% to – 20% (protection rating IP20)			
Frequency	Hz	48 – 60			
Power consumption (average)	VA	maximum 16; typical 8			
Approx. hours of operation with the YRB05Z rechargeable battery pack	h	40			
Selectable weight units		Grams, kilograms, carats			
Built-in interface		RS-232C-S/V24-V28; 7-bit; parity: even, odd, mark, or space; transmission rates: 150 to 19,200 baud; 1 or 2 stop bits; software/hardware handshake			

¹⁾ CD= Council Directive 90/384/ECC for non-automatic weighing instruments;
applicable to the European Economic Area



* Three-sided weighing pan: Ø = diameter of inner circle.
The cross-hatched section can be fully utilized.

Model		CPA34001S -OCE	CPA34001P -OCE	CPA16001S -OCE	CPA12001S -OCE	CPA34000 -OCE
Type		BF BL 500	BF BL 500	BF BL 500	BF BL 500	BF BL 500
Accuracy class ¹⁾		II	II	II	II	II
Maximum capacity, Max ¹⁾	kg	34	8/16/34	16	12	34
Scale interval, d ¹⁾	g	0.1	0.1/0.2/0.5	0.1	0.1	1
Tare range (subtractive)	g	≤ 100% of the maximum capacity				
Verification scale interval, e ¹⁾	g	1	1	1	1	1
Minimum capacity, Min ¹⁾	g	5	5	5	5	50
Response time (average)	s	≤ 2	≤ 2	≤ 2	≤ 2	≤ 1.5
Range of use according to CD ¹⁾	g	5–34,000	5–34,000	5–16,000	5–12,000	50–34,000
Allowable ambient operating temperature:						
– with “isoCAL” function	°C	+0° to +40° (+32° to +104°F)				
– without “isoCAL” function	°C	+10° to +30° (+50° to +86°F)				
Net weight, approx.	kg	16				
Weighing pan size	mm	300×400				
Dimensions (W×D×H)	mm	313×532×120				
AC power source/ power requirements	V~	AC adapter STNG6, 230 V or 115 V, +15% to –20% (protection rating IP20)				
Frequency	Hz	48 – 60				
Power consumption (average)	VA	maximum 16; typical 8				
Approx. hours of operation with the YRB06Z rechargeable battery pack	h	220				
Selectable weight units		Grams, kilograms, carats				
Cable length between display unit and weighing platform		1.20 m				
Built-in interface		RS-232C-S/V24-V28; 7-bit; parity: even, odd, mark, or space; transmission rates: 150 to 19,200 baud; 1 or 2 stop bits; software/hardware handshake				

¹⁾ CD= Council Directive 90/384/ECC for non-automatic weighing instruments;
applicable to the European Economic Area

Accessories (Options)

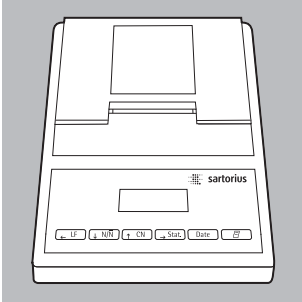

Product

Order No.

Data printer

with date, time, statistics evaluation and transaction counter functions and LCD

YDP03-OCE

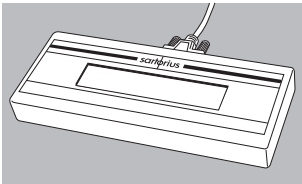

Remote display¹⁾ reflective (data interface required)

YRD02Z



External rechargeable battery pack

- for models with weighing capacities under 10 kg
 - for models with weighing capacities over 10 kg
- With battery-level indicator (LED); can be recharged using the AC adapter (time it takes to charge the discharged battery pack: 15 hours); see "Specifications" for hours of operation

YRB05Z

YRB06Z

To recharge the battery pack:

- Unplug the AC adapter from the balance and plug it into the battery pack

Carrying case

- for models with analytical draft shield chamber
- for models with weighing capacities up to 10 kg and without analytical draft shield chamber

YDB01CP

YDB02CP

¹⁾ Not available for verified balances

Product	Order No.
<p>SartoConnect,¹⁾ software for direct transfer of weighing data to an application program (e.g. Excel) from the CPA balance to a computer</p> <ul style="list-style-type: none"> - with RS-232C adapter cable; length: 1 m - with RS-232C adapter cable; length: 5 m - with RS-232C adapter cable; length: 15 m 	<p>YSC01L</p> <p>YSC01L YSC01L5 YSC01L15</p>
<p>Density determination kit¹⁾</p> <ul style="list-style-type: none"> - for CPA225D, CPA324S, CPA224S, CPA124S 	<p>YDK01</p>
<p>Antistatic weighing pan¹⁾</p> <ul style="list-style-type: none"> - for CPA225D, CPA324S, CPA224S, CPA124S, CPA64 	<p>YWP01CP</p>
<p>Calibration weights for all CPA balances; extensive assortment, optionally available with DKD certificate</p>	<p>Information available on request</p>
<p>Standard Operating Procedure optimum use of your balance in quality management systems</p>	<p>YSL07E</p>
<p>Industrial AC adapter, model ING1 for balances with weighing capacities up to 10 kg; protection rating: IP65 in accordance with DIN VDE 0470/DIN EN 60529</p> <ul style="list-style-type: none"> - for 230 V - for 120 V 	<p>69 71476 69 71480</p>
<p>Industrial AC adapter, model ING2 for balances with weighing capacities over 10 kg; protection rating: IP65 in accordance with DIN VDE 0470/DIN EN 60529</p> <ul style="list-style-type: none"> - for 230 V - for 120 V 	<p>69 71899 69 71500</p>
<p>Analytical draft shield chamber</p> <ul style="list-style-type: none"> - for CPA623S, CPA423S, CPA323S, CPA223S, GCA2502 	<p>YDS01CP</p>

¹⁾ Not available for verified balances

Product	Order No.
Draft shield cover with opening (Ø 30 mm)	
– for CPA623S, CPA423S, CPA323S, CPA223S, GCA2502	YDS02CP
Data cable	
– for PC connection, 25-pin	7357312
– for PC connection, 9-pin	7357314
Adapter:	
D-Sub 25-pin male connector to D-Sub 9-position, length: 0.25 m	6965619
Universal remote control switch	
for remote control of the following functions (configured in the balance menu): () (TARE), (CF) or (F) (see “Configuration” for details):	
Foot switch with T-connector	YFS01
Hand switch with T-connector	YHS02
T-connector	YTC01
△ The T-connector is not intended for use with multiple intelligent peripheral devices, such as PCs or YDPO3-OCE printers.	
Hanger for below-balance weighing¹⁾	
– for models CPA34001S, CPA34001P, CPA16001S, CPA12001S, CPA34000	69EA0040
Weighing bowl, nickel chromium steel, with pouring spout;	
– Weighing capacity: > 300 g; volume: 1,000 ml	641211
– volume 500 ml	641212
– volume 3,000 ml	641213
Dust cover	
– for display unit on models CPA34001S, CPA16001S, CPA34001P, CPA12001S, CPA34000	6960CP01
– for models CPA623S, CPA323S, CPA423S, CPA223S	6960CP02
– for models CPA6202S, CPA4202S, CPA2202S, CPA6202P, CPA10001, CPA8201, CPA5201, CPA2201-OCE	6960CP03
– for display and control unit on models CPA225D, CPA324S, CPA224S, CPA1003S, CPA1003P, CPA...-DS, CPA124, CPA64	6960CP04

¹⁾ Not available for verified balances

Declaration of Conformity

Weighing Instruments for Use in Legal Metrology:

Council Directive 90/384/EEC

“Non-automatic weighing instruments”

This Directive regulates the determination of mass in legal metrology.

For the respective Declaration of Type Conformity for weighing instruments that have been verified by Sartorius for use as legal measuring instruments and that have an EC Type-Approval Certificate, see the page after next.

This Directive also regulates the performance of the EC verification by the manufacturer, provided that an EC Type-Approval Certificate has been issued and the manufacturer has been accredited by an officer of a Notified Body registered at the Commission of the European Community for performing such verification.

Sartorius complies with EC Directive No. 90/384/EEC for non-automatic weighing instruments, which has been in effect since January 1, 1993, within the Single European Market, as well as the accreditation of the Quality Management System of Sartorius AG by Lower Saxony's Regional Administrative Department of Legal Metrology (Niedersächsisches Landesverwaltungsamt – Eichwesen) on February 15, 1993.

For additional information on the **CE** mark on Sartorius equipment, see Sartorius Publication No. W--0052-e93081.

“New Installation” Service

Initial verification is covered in our “New Installation” service package. In addition to initial verification, this package provides you with a series of important services which will guarantee you optimal results in working with your weighing instrument:

- Installation
- Startup
- Inspection
- Training
- Initial verification

“EC Verification” – A Service Offered by Sartorius

Our service technicians authorized to perform the verification* of your weighing instruments that are acceptable for legal metrological verification can inspect and verify the metrological specifications at the place of installation within the Member States of the European Union and the Signatories of the Agreement on the European Economic Area.

Subsequent Verifications within the European Countries

The validity of the verification will become void in accordance with the national regulations of the country in which the weighing instrument is used. For information on verification and legal regulations currently applicable in your country, and to obtain the names of the persons to contact, please contact your local Sartorius office, dealer or service center.

For more information on the verification of weighing instruments for use in legal metrology, contact the Sartorius Service Center.

* = in accordance with the accreditation certificate received by Sartorius AG



sartorius
mechatronics

CE EG-Konformitätserklärung EC Declaration of Conformity

Sartorius AG
37070 Göttingen
Germany

erklärt, dass das Betriebsmittel
declares that the equipment

Gerät: **Elektronische Präzisionswaage**
Apparatus: Electronic precision weighing instrument

Baureihe / Batch: **CP / CPA / GP / GC-...**

Typbezeichnung: **Siehe Anhang 1**
Type: See Annex 1

mit den Regelungen der folgenden Europäischen Richtlinien übereinstimmt:
complies with the regulations of the following European Directives:

Richtlinie 2004/108/EG **Elektromagnetische Verträglichkeit**
Directive 2004/108/EC Electromagnetic compatibility

Richtlinie 2006/95/EG **Elektrische Betriebsmittel zur Verwendung innerhalb bestimmter Spannungsgrenzen**
EC Directive 2006/95/EC Electrical equipment designed for use within certain voltage limits

Das Gerät erfüllt die anwendbaren Anforderungen der in Anhang 2 aufgeführten harmonisierten Europäischen Normen.
The apparatus meets the applicable requirements of the harmonized European Standards listed in Annex 2.

Sartorius Mechatronics
Göttingen, 2007-09-05

Dr. Manfred Rahe
Leitung
Neue Technologien
Sparte Mechatronik
*Head of New Technologies
Mechatronics Division*

Dr. Dieter Klausgrete
Leitung
International Certification Management
Sparte Mechatronik
*Head of International Certification Management
Mechatronics Division*

CE Declaration of Type Conformity to Directive No. 90/384/EEC

This declaration is valid for non-automatic electromechanical weighing instruments for use in legal metrology. These weighing instruments accepted for legal metrological verification have an EC Type-Approval Certificate. The model(s) concerned is (are) listed below along with the respective type, accuracy class, and EC Type-Approval Certificate number:

Model	Weighing instrument type	Accuracy class	EC type-approval certificate no.
CPA...-CE	BC BL 100	Ⓢ	D01-09-019
CPA...-CE	BD BL 100	Ⓢ	D01-09-019
CPA...-CE	BD BL 200	Ⓢ	D01-09-019
CPA...-CE	BF BL 500	Ⓢ	D01-09-019
GCA...-CE	BC BL 100	Ⓢ	D01-09-019
GPA...-CE	BD BL 200	Ⓢ	D01-09-019

SARTORIUS AG declares that its weighing instrument types comply with the requirements of the Council Directive on non-automatic weighing instruments, no. 90/384/EEC of 20 June 1990; the associated European Standard "Metrological aspects of non-automatic weighing instruments," No. EN 45501; the most recently amended versions of the national laws and decrees concerning legal metrology and verification in the Member States of the European Union, the EU, and the Signatories of the Agreement on the European Economic Area, which have adopted this Council Directive into their national laws; and with the requirements stipulated on the Type-Approval Certificate for verification. This Declaration of Type Conformity is valid only if the ID label on the weighing instrument has the CE mark of conformity and the green metrology sticker with the letter

"M" stamped on it (the two-digit number in large print stands for the year in which the mark was affixed):

Example (date/year and number of the notified body may vary):



If these marks are not on the ID label, this Declaration of Type Conformity is not valid. Validity can be obtained, for example, by submitting the weighing instrument for final processing by an authorized representative of SARTORIUS AG. The period of validity of this Declaration of Type Conformity shall expire upon any tampering with, repair or modification of this weighing instrument or, in some Member States, on the date of expiration. This declaration applies only to the weighing instrument without peripheral devices.

The operator of this weighing instrument shall be responsible for obtaining an authorized renewal of the verification, such as subsequent or periodic verification, of the weighing instrument for use as a legal measuring instrument.

Sartorius AG
37070 Goettingen, Germany
Signed in Goettingen on 11 April 2008

Dr. G. Maaz
President of the Mechatronics Division

J. Rehwald
Head of Production Department
Mechatronics / Weighing Technology Division

Physikalisch-Technische Bundesanstalt

Braunschweig und Berlin

PTB



EG-Bauartzulassung

EC type-approval certificate

Zulassungsinhaber: Sartorius AG

Issued to:

Weender Landstr. 94-108
37075 Göttingen

Rechtsbezug:

In accordance with:

§ 13 des Gesetzes über das Mess- und Eichwesen (*verification act*) vom/dated 23. März 1992 (BGBl. I S. 711), zuletzt geändert am (*last amended on*) 02.02.2007 (BGBl. I S. 58), in Verbindung mit Richtlinie (*in connection with council directive*) 90/384/EWG, geändert durch (*amended by*) 93/68/EWG

Bauart:

In respect of:

Nichtselbsttätige elektromechanische Waage mit oder ohne Hebelwerk
Nonautomatic electromechanical weighing instrument with or without lever system

Typ / Type:

BC BL 100, BD BL 100, BD BL 200, BF BL 500

(I) Max 50...1200 g, e = 1...20 mg, n ≤ 320000 Option: Mehrteilungswaage
(II) Max 1...34000 g, e = 0,1...5 g, n ≤ 62000 *multi-interval instrument*
(III) Max 100...34000 g, e = 1...50 g, n ≤ 10000

Zulassungsnummer:

Approval number:

D01-09-019 6. Revision

Gültig bis:

Valid until:

03.09.2011

Anzahl der Seiten:

Number of pages:

10

Geschäftszeichen:

Reference No.:

PTB-1.12-4032143

Benannte Stelle:

Notified Body:

0102

Im Auftrag

By order

Marcus Link



Braunschweig, 18.10.2007

Siegel
Seal

RS-0023

Die Hauptmerkmale, Zulassungsbedingungen und Auflagen sind in der Anlage enthalten, die Bestandteil der Revision der EG-Bauartzulassung ist. Hinweise und eine Rechtsbehelfsbelehrung befinden sich auf der ersten Seite der Anlage

The principal characteristics, approval conditions and special conditions, if any, are set out in the Annex which forms an integral part of this Revision of the EC type-approval certificate. For notes and information on legal remedies, see first page of the Annex.

Plates and Markings

Types BC BL 100, BD BL 100, BD BL 200

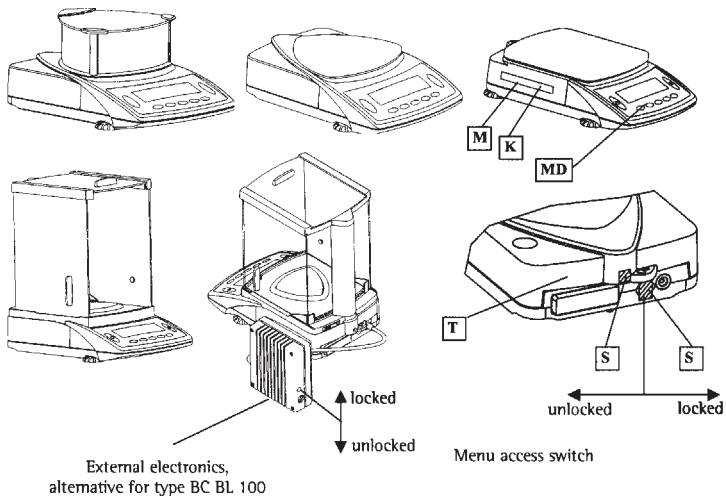

Type BF BL 500

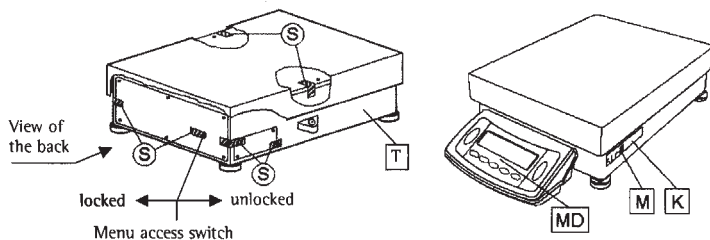

- K** Descriptive plate with CE mark of conformity
- M** Mark for EC verification (green metrology sticker)
- S** Protective seal, for accuracy classes (II) and (III) only
- MD** Metrological data
- T** Plate with model designation

Type: BC BL 100, BD BL 100, BD BL 200, BF BL 500
EC type-approval certificate D01-09-019

Example of plate with model designation **T**



Example of descriptive plate on a weighing instrument already verified **K**

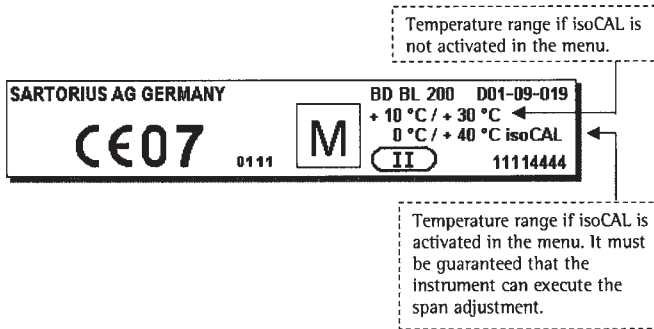

Sartorius AG
Weender Landstrasse 94–108
37075 Goettingen, Germany

Phone +49.551.308.0
Fax +49.551.308-32 89
www.sartorius-mechatronics.com

Copyright by Sartorius AG,
Goettingen, Germany.
All rights reserved. No part
of this publication may
be reprinted or translated in
any form or by any means
without the prior written
permission of Sartorius AG.
The status of the information,
specifications and illustrations
in this manual is indicated
by the date given below.
Sartorius AG reserves the
right to make changes to the
technology, features,
specifications and design of the
equipment without notice.

Stand:
April 2008, Sartorius AG,
Goettingen, Germany

Printed in Germany on paper that has
been bleached without any use of chlorine.
W1A000 · KT
Publication No.: WCP6007-e08045