

Thermo Scientific Cytospin 4  
Operator Guide  
A78310250 Issue 6



**Thermo**  
SCIENTIFIC



## Company Information

© Copyright 2015. Thermo Fisher Scientific Inc. All rights reserved.

Thermo Fisher Scientific Inc. is the world leader in serving science, offering a unique combination of innovative technologies. Thermo Scientific is a brand name of Thermo Fisher Scientific Inc.

All other trademarks are the property of Thermo Fisher Scientific Inc. and its subsidiaries.

Thermo Fisher Scientific Inc. makes every attempt to ensure that the information contained in this supporting document is correct and clearly stated, but does not accept responsibility for any errors or omissions. The development of Thermo Scientific products and services is an ongoing process. Please ensure that any published information you use as a reference is up to date and relates to the condition of the product. If necessary, check with your local Thermo Fisher Scientific Inc. representative.

This document may not, in whole or in part, be copied, photocopied, reproduced, translated or converted to any electronic or other form without prior written consent of Thermo Fisher Scientific Inc. All information contained in this manual is proprietary and confidential, and the exclusive property of Thermo Fisher Scientific Inc. and is protected by copyright.

## Contact Addresses



Thermo Scientific Limited  
 (subsidiary of Thermo Fisher Scientific)  
 Tudor Road  
 Manor Park  
 Runcorn  
 WA7 1TA  
 UK

**USA Distributor:** Richard-Allan Scientific Co.  
 (subsidiary of Thermo Fisher Scientific)  
 4481 Campus Drive, Kalamazoo, MI 49008 USA  
 Tel: 1-800-522-7270; Fax: +1 269-372-2674;  
 Web: [www.thermoscientific.com/pathology](http://www.thermoscientific.com/pathology)



This instrument conforms to the essential requirements of:  
 In Vitro Diagnostic Directive 98/79/EC  
 Machinery Directive 2006/42/EC

## **EMC Statement**

This IVD equipment complies with the emissions and immunity requirements of IEC 61326-2-6:2006.

This equipment has been designed and tested to CISPR 11 Class A.

It is intended for use in a laboratory environment by qualified and trained laboratory personnel only. In a domestic environment it may cause radio interference, in which case it may be necessary to take measures to mitigate the interference.

## Safety Information

Thermo Fisher Scientific Inc. instruments are designed for convenient and reliable service; however, improper use or handling by a user may damage the instrument or cause a hazard to health. The instrument must not be used in a manner not specified by Thermo Fisher Scientific Inc. Correct maintenance procedures are essential for consistent performance. It is recommended that users secure a maintenance contract with our service department.

Any problems and queries should be referred to your Thermo Fisher Scientific Inc. service representative.



**The following sections contain important information for the safe setup and use of the instrument, and should be read and understood by the user before using the instrument.**

## General Safety



This instrument, as supplied, conforms to IEC61010-1 and IEC61010-2-101; however, the addition of chemicals introduces potential hazards. Good Laboratory Practice must be employed and consideration must be given to the potential for hazard when dealing with these chemicals.



Do not use this instrument in close proximity to strong electromagnetic radiation as this may interfere with the proper operation. The electromagnetic environment should be evaluated prior to operation of the device.



Good Laboratory Practice must be used when handling tissue samples to prevent cross contamination and infection. The user should complete a risk assessment to determine any potential hazards related to tissue handling.



The Cytospin bioseals and related components are intended to be part of the bio-containment systems such as are specified in International and National bio-safety guidelines, and cannot be relied upon as the only means of safeguarding workers and the environment when handling pathogenic microorganisms.



- Do not introduce any source of ignition into, or near, the instrument once it has been loaded with reagents.
- Do not remove any panels or access covers, unless specifically instructed to do so. Potentially lethal voltages are present inside the instrument.
- The instrument must be properly connected to a good earth (ground) via the Mains input supply and positioned such that it is possible to interrupt the Mains supply at the source by removing the plug from the socket.
- Use only factory approved accessories or replacement parts with this instrument.
- Only use reagents recommended in the Operator Guide.
- Disconnect the instrument from the mains supply before performing maintenance.
- Take the necessary precautions when handling glass. Wear Personal Protective Equipment (PPE) if required.

## Symbols

The following symbols and conventions may be used throughout this document and on the instrument:



This symbol is used on the instrument, or in a document, to indicate that instructions must be followed for safe and correct operation. If this symbol appears on the instrument, always refer to the operator guide.



This symbol is used on the instrument, or in a document, to indicate that there are potential biological risks associated with the instrument and / or instrument use. Always use Good Laboratory Practice.



This symbol is used on the instrument, or in a document, to indicate that irritants or potentially harmful chemicals are present. Refer to the Material Safety Data Sheets for the products used, and always use Good Laboratory Practice.



Single Use.



This symbol is used on the instrument, or in the document, to indicate that instructions for use must be consulted.



Manufacturer.



This symbol indicates the product is an In Vitro Diagnostic Medical Device according to European Directive 98/79/EC.

## Chemical Safety

The introduction of chemicals creates potential hazards. Thermo Fisher Scientific Inc. has adopted the following position with regard to the subject of volatile chemicals used in laboratories:



- Customers using non-specified chemicals in the instrument do so at their own risk.
- All chemicals recommended by Thermo Fisher Scientific Inc. have auto-ignition temperatures considerably above any surface temperature that can be reached during a single fault failure on the instrument.
- The instrument contains no source of ignition in any areas of the instrument where chemicals are stored, or are likely to leak into in a single fault condition.
- The operator is fully aware of the contents of the specification documents detailing the properties of the chemicals they are using.
- The operator has carried out any legally required assessment of chemicals used and is using good laboratory practice.

## Environment

This instrument is required to comply with the European Union's Waste Electrical and Electronic Instrument (WEEE) Directive 2002/96/EC. It is marked with the following symbol:



Thermo Fisher Scientific Inc. has contracts with one or more recycling / disposal companies in each EU Member State, and this product should be disposed of or recycled through them. For further information contact your Thermo Fisher Scientific Inc. service representative

## Warranty Statement

Thermo Fisher Scientific Inc. is proud of their quality, reliability and after-sales services. We continuously strive to improve our service to our customers.

Please ask your distributor or Thermo Fisher Scientific Inc. representative about service contracts which can help maintain your instrument in an optimal operating condition.

Warranty provisions necessarily vary to comply with differences in national and regional legislation. Specific details can be found in the delivery documentation or from your dealer or representative.

Please note that your warranty may be invalidated if:

- This instrument is modified in any way, or not used as intended by Thermo Fisher Scientific Inc.
- Accessories and reagents which have not been approved by Thermo Fisher Scientific Inc. are used.
- The instrument is not operated or maintained in accordance with instructions.

## Table of Contents

<b>COMPANY INFORMATION.....</b>	<b>3</b>
<i>EMC Statement.....</i>	<i>4</i>
SAFETY INFORMATION.....	5
GENERAL SAFETY.....	5
SYMBOLS.....	6
CHEMICAL SAFETY.....	7
ENVIRONMENT.....	7
WARRANTY STATEMENT.....	7
TABLE OF CONTENTS.....	8
<b>CHAPTER 1 – INTRODUCTION TO THERMO SCIENTIFIC CYTOSPIN 4.....</b>	<b>12</b>
IVD INTENDED USE.....	12
INTRODUCTION TO THE CYTOSPIN 4.....	12
APPROVED REAGENTS.....	13
SYSTEM SPECIFICATIONS.....	14
<i>Mechanical Specification.....</i>	<i>14</i>
<i>Electrical Specification.....</i>	<i>14</i>
<i>Environmental Specifications.....</i>	<i>14</i>
<b>CHAPTER 2 – INSTALLATION AND SETUP.....</b>	<b>15</b>
UNPACKING.....	16
OPENING AND CLOSING THE CYTOSPIN 4 LID.....	17
EMERGENCY RELEASE.....	17
OPENING AND CLOSING THE SEALED HEAD.....	18
ELECTRICAL REQUIREMENTS.....	19
SWITCHING ON AND OFF.....	20
<i>To Switch On.....</i>	<i>20</i>
<i>To Switch Off.....</i>	<i>20</i>
ACCESSORIES.....	21
<i>Thermo Scientific EZ Single Cytofunnel.....</i>	<i>21</i>
<i>Thermo Scientific EZ Double Cytofunnel.....</i>	<i>22</i>
<i>Thermo Scientific EZ Megafunnel.....</i>	<i>23</i>
EZ MEGAFUNNEL – END OF SPIN PROCESSING RUN.....	24
<b>CHAPTER 3 – CONTROLS.....</b>	<b>25</b>
MAIN CONTROL PANEL.....	25
<i>Program Keypad.....</i>	<i>25</i>



<i>Control Keypad</i> .....	27
<i>Status Display</i> .....	28
<b>CHAPTER 4 – METHOD OF OPERATION</b> .....	<b>29</b>
OPERATING THE THERMO SCIENTIFIC CYTOSPIN 4.....	31
LOADING THE CYTOSPIN 4.....	33
<i>Loading the EZ Cytofunnel</i> .....	33
<i>Loading the Sealed Head</i> .....	34
<i>Selecting a Program</i> .....	36
<i>Saving a Program</i> .....	36
<i>Entering the Time Required</i> .....	37
<i>Entering the Speed Required</i> .....	37
<i>Entering the Acceleration Required</i> .....	38
<i>Starting a Run</i> .....	38
<i>Unloading the Thermo Scientific Cytospin 4</i> .....	38
<i>Error Codes, Audible Tones and Warnings</i> .....	39
<b>CHAPTER 5 – CLEANING AND MAINTENANCE</b> .....	<b>40</b>
ROUTINE CLEANING AND MAINTENANCE.....	41
<i>Front Panel</i> .....	41
<i>Lid, Case, Plinth and Bowl Liner</i> .....	41
<i>Sealed Head Assembly</i> .....	42
<i>Sealed Head Base</i> .....	42
<i>Support Plate</i> .....	43
<i>Sealed Head Lid</i> .....	43
SEAL REPLACEMENT.....	44
<i>Cone Seal</i> .....	44
<i>Lid Seal</i> .....	45
<b>CHAPTER 6 – TROUBLESHOOTING</b> .....	<b>46</b>
TABLE 1 – INSTRUMENT FUNCTION.....	46
<i>Error Codes</i> .....	46
TABLE 2 – ERROR CODES.....	47
TABLE 3 - UNSATISFACTORY CYTOCENTRIFUGATION RESULTS – QUALITY.....	48
TABLE 4 - UNSATISFACTORY CYTOCENTRIFUGATION RESULTS – QUALITY (NUMBER OF CELLS).....	49
TABLE 5 – UNUSUAL PATTERN OF CELL POPULATION DISTRIBUTION.....	50

TABLE 6 – SUMMARY.....	51
<b>CHAPTER 7 – SPARES AND ACCESSORIES.....</b>	<b>52</b>
<b>APPENDICES.....</b>	<b>54</b>
APPENDIX A – STANDARD WORKFLOW DIAGRAM.....	54
APPENDIX B – METHODOLOGY GUIDELINES.....	56
<i>General Theory – Introduction</i> .....	56
<i>General laboratory Considerations</i> .....	56
SPECIMEN PREPARATION.....	57
<i>Initial Examination</i> .....	57
<i>Determination of Cell Number</i> .....	58
<i>Cells / 40x field as a guideline to the number of drops of cell suspension / Thermo Scientific Cytospin 4 sample chamber</i> .....	59
<i>Specimen Enrichment</i> .....	60
<i>Specimen Dilution</i> .....	61
<i>Loading the Thermo Scientific Cytospin 4 Sample Chambers</i> .....	61
<i>Selecting Time, Speed and Acceleration</i> .....	62
<i>Unloading the Sample Chambers</i> .....	62
<i>Evaluation of Specimen to Assess Technique</i> .....	62
<i>Fixation</i> .....	63
SPECIAL CONSIDERATIONS.....	65
<i>Cell Adhesion</i> .....	65
<i>Cytology</i> .....	65
<i>Haematology</i> .....	66
<i>Urine Specimens</i> .....	66
<i>Microbiology</i> .....	66
THE USE OF THE THERMO SCIENTIFIC CYTOSPIN 4 FOR HAEMATOLOGY AND OTHER CLINICAL MICROSCOPY SPECIMENS.....	68
<i>Introduction</i> .....	68
<i>Uses and Application</i> .....	68
<i>Methodology Guidelines</i> .....	69
<i>Suggestions for Optimal Thermo Scientific Cytospin 4 Technique</i> .....	70
APPENDIX C – TRANSPORTATION INSTRUCTIONS.....	71
<i>Repacking</i> .....	71
APPENDIX D – APPROVED REAGENT LIST.....	73

*Reagent List*..... 73

*Cleaning Agents*..... 73

INDEX..... 74

## Chapter 1 – Introduction to Thermo Scientific Cytospin 4



### IVD Intended Use

The Thermo Scientific Cytospin 4 is an in vitro diagnostic device.

The Thermo Scientific Cytospin 4 is a self-contained cyto-centrifuge whose primary function is to produce a monolayer of cells onto a glass slide from any fluid suspension.

The Thermo Scientific Cytospin 4 is designed for use in Pathology Laboratories and only trained and qualified laboratory personnel may operate the Thermo Scientific Cytospin 4.

### Introduction to the Cytospin 4

The different components of the Thermo Scientific Cytospin 4 (Cytospin 4) centrifuge are shown in the diagram below.

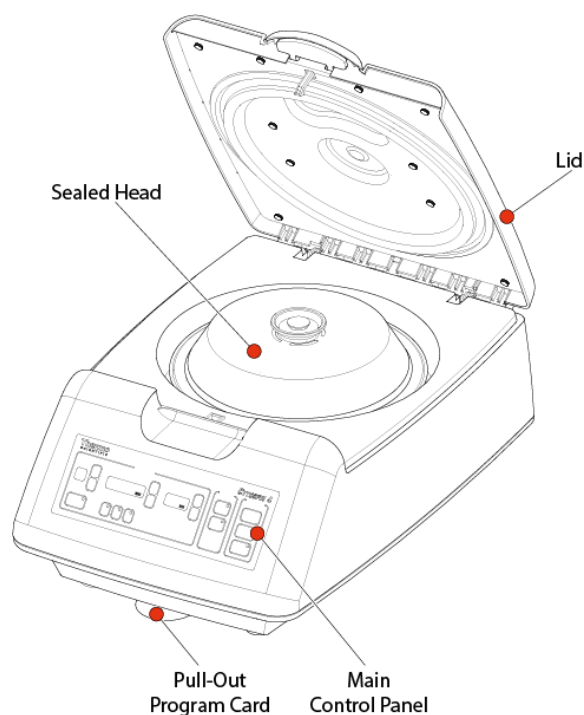

Special design features of the Cytospin 4 include:

- Lid release mechanism that allows for easy one-handed opening of the Cytospin 4 to load and unload the sealed head.
- New control panel for easy user interface.
- An intuitive way to set programs and interact with all Cytospin 4 applications.
- Additional visual and audible indicators that help to trouble-shoot the instrument.
- Fully programmable memory - up to 23 programs can be easily stored and recalled.
- A pull-out program card allows you to easily reference each program.
- Power Save feature.



The only routine maintenance of the centrifuge that the operator is required to perform is contained in [Chapter 5 - Cleaning and Maintenance](#).

It is recommended that a Maintenance Contract is taken out with the Thermo Fisher Scientific Service Department or a Thermo Fisher Scientific approved distributor.



The Cytospin 4 has been designed with safety in mind. However, if it is not used in accordance with the instructions in this Operator Guide, the protection may be impaired.

## Approved Reagents



The Cytospin 4 must only be used with the reagents from the approved reagents from the approved reagent list show in Appendix D – Approved Reagents List.

## System Specifications

### Mechanical Specification

Width	405 mm (max)	(16 ins)	
Depth	620 mm	(24½ ins)	
Height	240 mm	(9½ ins)	(lid down)
	625 mm	(25 ins)	(lid up)
Weight	12 kg	(26½ lbs)	

### Electrical Specification

Voltage	100-240 V~ +/- 10%		
Current	50/60Hz		
Power	150VA		
Fuses	Mains Plug	5A 250V	
	Mains Fuses (x2)	T5A 250V	

### Switch Convention

I	Power On
O	Power Off

### Sound Power level

<53dB (this should not present any hazard to the user).

### Program Details

Time	1 - 99 minutes
Speed	200 - 2000 rpm ( <i>in increments of 10rpm</i> )
Acceleration	High, Medium, Low

### Environmental Specifications

<b>Warning – For indoor use only</b>	
Temperature (Operating Limits)	+2°C to +40°C
Temperature (Transportation and Storage)	-25°C to +55°C (+70°C for short exposure)
Relative Humidity	Max. 80% RH up to 31°C Decreasing linearly to 50% RH at 40°C
Altitude	Up to 2,000 m (6,500 ft)
Pollution Degree	Level 2
Over Voltage Category	II

## Chapter 2 – Installation and Setup

The Cytospin 4 is a precision instrument that must be unpacked and installed with care.



There must be at least 300mm of clear space around Cytospin 4. The operator must not stay in the clearance envelope longer than necessary for operational reasons.

Do not deposit any potentially hazardous material within the clearance envelope.

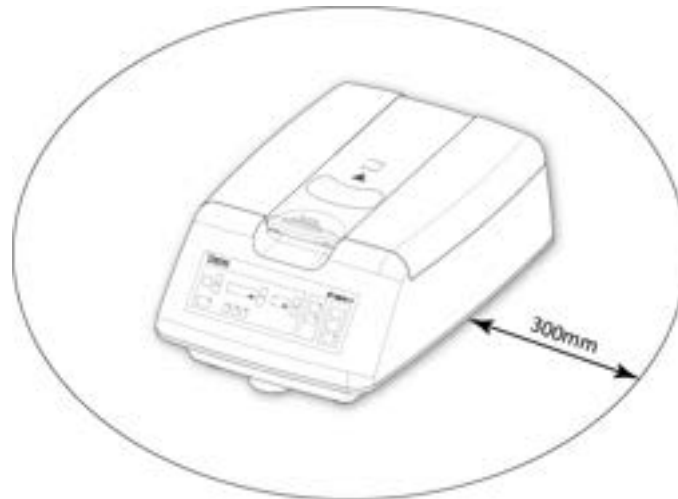

Make sure the vents on the sides and underneath of the Cytospin 4 are not covered.

The Cytospin 4 weighs approximately 12 kilograms. If necessary, get help to safely move or lift the instrument without risk of injury.

The Cytospin 4 must be operated on a flat, stable laboratory bench that is made of a non-flammable material.

Do not lean on the instrument whilst it is on operation.

Position the instrument such that it is possible to interrupt the Mains supply at the source by removing the plug from the socket.

## Unpacking

Inspect the packaging and the condition of the instrument. If either have been damaged, or there are missing parts listed on the packing list supplied with the instrument, contact your local Thermo Fisher Scientific representative.

Remove the top layer of packaging from the Cytospin 4. Get help if necessary to lift the instrument from the box and to place it on the bench.

When unpacking the Cytospin 4, do not discard the packaging, store it flat for future use.

If you are required to transport the instrument, refer to [Appendix C – Transportation Instructions](#).

To lift or move the Cytospin 4, hold the instrument securely under the sides of the unit.



Disconnect the Cytospin 4 from the mains power before lifting or moving the Cytospin 4.





## Opening and Closing the Cytospin 4 Lid

The lid handle is situated at the front of the instrument, with the latch just underneath it.

To open the lid, squeeze the lid handle and latch together.

To close the lid, lower the lid and make sure that the lid latch has engaged.

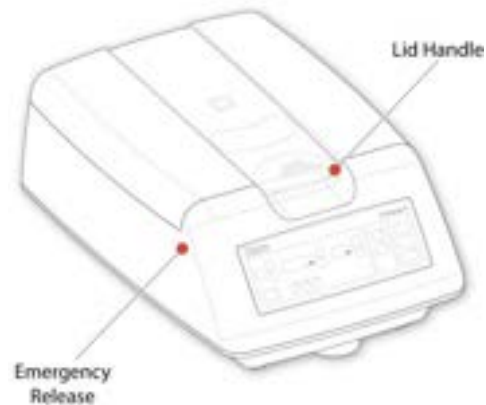

It is necessary to open and close the lid when the Cytospin 4 is first switched on in order to initialise the instrument, (if the lid is already open it is only necessary to close the lid). The lid open LED will flash until this procedure is carried out.

## Emergency Release

### Note

*If the lid is locked and power is not available, use the Emergency Release.*

To use the Emergency Release, remove the small cap on the left side of the instrument



Then insert the lock release tool:

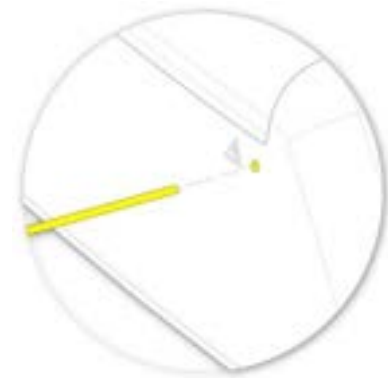

Push the tool inward to release the lock. Then use the lid handle and latch to open the lid.



**Do not open the lid if the head is still spinning. Never force the lid open.**

## Opening and Closing the Sealed Head

Open the lid and remove the foam packing from the top of the sealed head assembly then lift the sealed head assembly out of the Cytospin 4. Remove all the packing pieces.



To open the sealed head, pull up the centre button of the lid of the sealed head until it 'clicks', then lift off the lid.



### Note

*The lid of the sealed head fits snugly in the rubber seal of the base. You may need to tilt the lid gently before you lift it off.*

*If necessary, hold the lid of the sealed head with one hand and pull up the centre button with the other.*

To close the sealed head, place the lid in position on the seal of the base. Make sure that the lid sits on the seal correctly. To secure the lid, push down the centre button.



**Never lift the sealed head by the central locking knob.**



**To avoid damage to the Cytospin 4, do not open or close the sealed head assembly when it is installed in the instrument**

## Electrical Requirements

Make sure that the voltage of the mains supply corresponds with the voltage rating on the rating plate on the back of the instrument.

### Note

*The - symbol on the rating plate indicates that the instrument operates on an alternating current supply (a.c.).*

Make sure that the **I / O** power switch at the rear of the instrument is switched off (**O** side of the switch pushed inward).

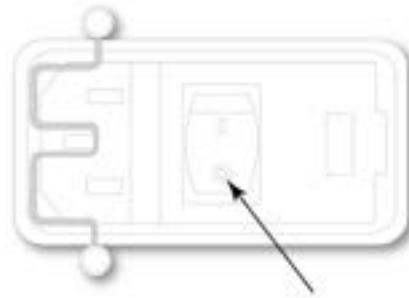

Instruments are supplied with an appropriate power cord with a moulded plug. If another plug is required, it is necessary for a technically competent person to remove the moulded plug from the supplied power cord and fit a suitably rated, and where appropriate, fused plug using the wiring convention shown below:

European Cable	US Cable	Terminal
Brown	Black	Live (L or L2)
Blue	White	Neutral (N or L1)
Green / Yellow	Green	Earth – E, ground or 

Insert the power cord into the mains connector on the rear panel of the instrument and clip the cable restraint over the mains connector. Connect the power cord to the local power supply outlet.



**US ONLY:** For 208Vac supply system, connect the instrument to a centre-tapped, single phase supply circuit.



The Cytospin 4 must be protectively earthed. Make sure that the instrument is plugged into a properly earthed mains supply.



It must be possible to interrupt the mains supply at source by removing the plug from the mains supply socket.



Always disconnect the Cytospin 4 from the mains power before lifting or moving the instrument.

## Switching On and Off

### To Switch On

Press the **I** (ON) side of the **I/O** switch inward to switch the instrument on.

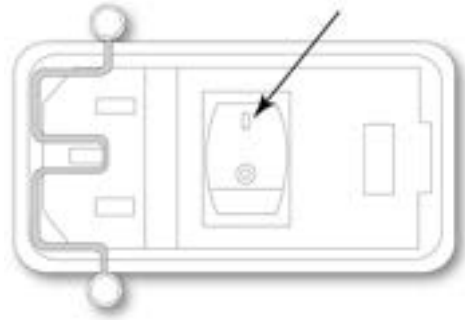

When the Cytospin 4 is switched on, you should notice the following:

1. All the displays and LEDs will light.
2. The power up tune will be played.
3. The last program used will be displayed.
4. The Lid Open LED will flash.

### To Switch Off

When the instrument is regularly used, the instrument should be switched off by using the Standby button [  ] on the Main Control Panel.



#### Note

*The red LED is lit when the instrument is in Standby mode.*

To restart the instrument, press the [  ] button again. The displays will show the previous settings.



**Never cover the switch that cuts power to the instrument**

If the instrument is to be left unattended for long periods of time, or is to be moved, the power to the instrument should be turned off. Press the **O** (OFF) side of the power switch to switch off the Cytospin 4.

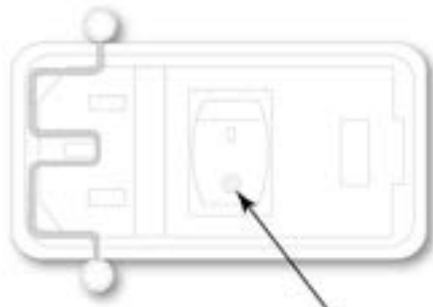

## Accessories

The following accessories are available for the Cytospin 4.

### Thermo Scientific EZ Single Cytofunnel



The Thermo Scientific EZ Single Cytofunnel (EZ Single Cytofunnel) is a single use, disposable sample chamber.

There are two versions of the EZ Single Cytofunnel:

#### White filter card

- for sample volumes up to 0.5ml
- filter card for high absorbency

#### Brown filter card

- for sample volumes up to 0.4ml.
- filter card for low absorbency - excellent for scanty specimens such as CSF.

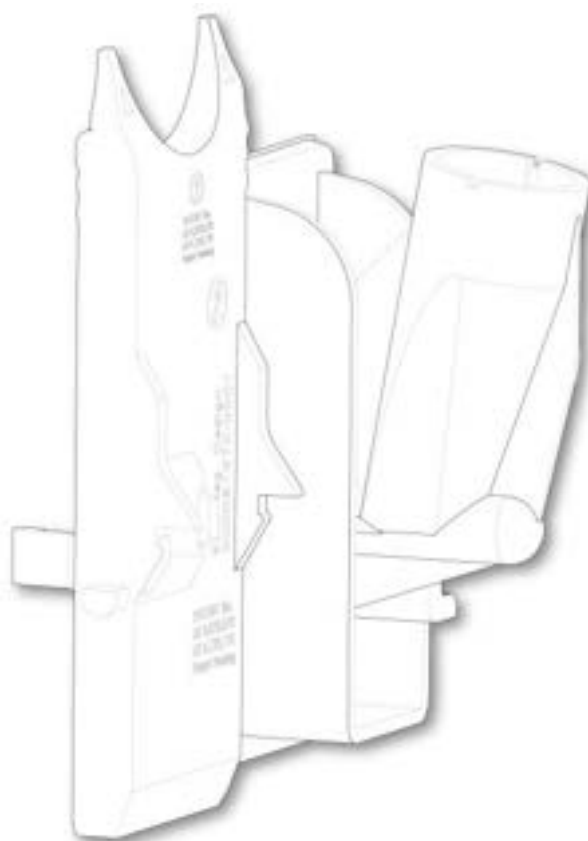

#### Note

*Use only 1.0mm thick glass slides.*

The EZ Single Cytofunnel is loaded, spun and unloaded as described in [Chapter 4 - Operation](#).



Maximum run duration for EZ single Cytofunnel is 60 minutes. If this is exceeded, there is a small risk that the slide may crack.



Maximum rotation speed for the EZ Single Cytofunnel is 2000rpm.



Be aware of samples used. They may pose a bio hazard. Use the correct PPE whilst handling biologically hazardous materials

## Thermo Scientific EZ Double Cytofunnel



The Thermo Scientific EZ Double Cytofunnel (EZ Double Cytofunnel) is a single use, disposable sample chamber that allows 2 samples to be prepared at the same time

A maximum of 0.25ml of sample can be loaded into each side of the EZ Double Cytofunnel (0.5ml in total).



### Note

*It is recommended that the same sample is used in each side of the EZ Double Cytofunnel.*

The EZ Double Cytofunnel is loaded, spun and unloaded in the same way as the EZ Single Cytofunnel described in [Chapter 4 - Operation](#).



Maximum run duration for EZ Double Cytofunnel is 60 minutes. If this is exceeded, there is a small risk that the slide may crack.



Maximum rotation speed for the EZ Double Cytofunnel is 2000rpm.



Be aware of samples used. They may pose a bio hazard. Use the correct PPE whilst handling biologically hazardous materials

## Thermo Scientific EZ Megafunnel



The Thermo Scientific EZ Megafunnel (EZ Megafunnel) is a single use, disposable sample chambers designed for larger volumes of fluids (0.5ml - 6ml).



Load and spin the samples in the same way as the EZ Single Cytofunnel (described in [Chapter 4 - Operation](#)).

## EZ Megafunnel – End of Spin Processing Run

When the Cytospin 4 has stopped spinning, remove the sealed head to a safe and convenient area. Make sure the sealed head is kept level.

Remove each EZ Megafunnel from the sealed head. Make sure that you keep the EZ Megafunnel tilted away from the slide to prevent the excess fluid touching the slide.

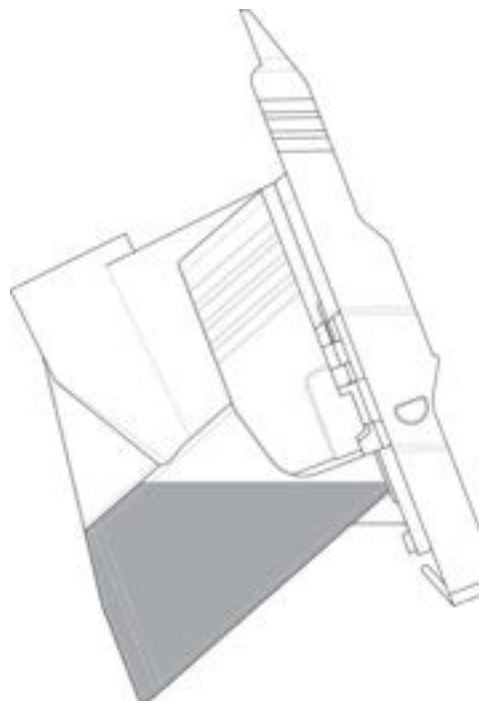

- Press the release lever so that the lock catch is released. This allows the funnel to be opened and the slide carefully removed. Pour off the excess fluid from the EZ Megafunnel.
- Discard the EZ Megafunnel directly into the appropriate waste receptacle depending on the specimens and materials used, according to your local laboratory procedure.
- Hold the slide with the rectangular cell deposition area upward. Place on the bench for 5 minutes. (Depending on the application, slide preparations may be air-dried, spray fixed or placed into 95% alcohol). Stain the slide as required.

### Note

*Spray fixed slides or preparations that used Thermo Scientific Cytospin® collection fluid should be placed into 95% alcohol for 10 minutes (to remove the Carbowax®) before proceeding with the staining procedure.*



Maximum speed for EZ Megafunnel is 1500 rpm. If this is exceeded, there is a small risk that the slide may crack.



Be aware of samples used. They may pose a bio hazard. Use the correct PPE whilst handling biologically hazardous materials



## Chapter 3 – Controls

This chapter describes the functions of all the controls on the instrument.

### Main Control Panel

The Main Control Panel is situated on the front of the instrument.

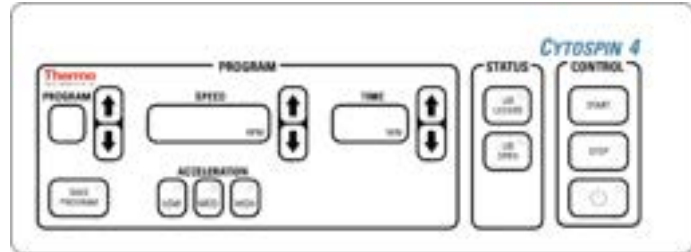

### Program Keypad

This keypad allows the user to select or save a program, set the speed, time and rate of acceleration for a run.

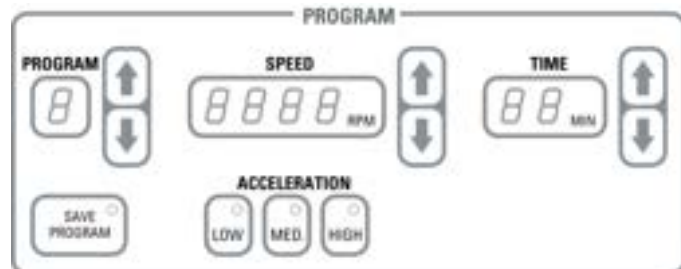

#### *Program*

The display shows the program selected. Up to 23 programs can be stored, indicated by the following numbers and letters:

- 1, 2, 3, 4, 5, 6, 7, 8, 9,
- A, c, d, E, F, H, L, n, o, P, r, t, u, Y



The up arrow increments the program indicator; the down arrow decrements the program indicator.

#### **Note**

*The instrument has programs loaded at the factory. The program locations can be overwritten.*

#### *Speed*

The display shows the run speed in revolutions per minute (rpm) (from 200 to 2000 rpm).

The up arrow increments the speed. If it is pressed once, the speed will be increased in steps of 10 rpm.

The down arrow decrements the speed. If it is pressed once, the speed will be decreased in steps of 10 rpm.

If either button is held down, the speed will be incremented or decremented in steps of 50 rpm.



### *Time*

The display shows the run time in minutes (from 1 to 99 minutes).



The up arrow increments the time. If it is pressed once, the time will be increased in steps of 1 minute. The down arrow decrements the time. If it is pressed once, the time will be decreased in steps of 1 minute.

If either button is held down, the time will be incremented or decremented in steps of 10 minutes.

### *Acceleration*

Press [LOW], [MED.] or [HIGH] to select the rate of acceleration required. The LED will light to show which rate has been selected.



### *Save Program*

The [SAVE PROGRAM] button stores the set time, acceleration and speed information into the program selected.



The LED will flash if a program or amended programs have not been saved. The LED will switch off when the program is saved.

### *End of Run Specimen Warning*



This warning is a safety feature to protect the specimen in the Cytospin 4 after the program has finished.

When the program has finished, a tune will be played to alert the operator. If it is likely that the operator will be away from the Cytospin 4 when the program is due to finish, it is possible to program the Cytospin 4 to repeat the 'end of run' tune at 1 minute intervals.

- To repeat the tune at 1 minute intervals, hold down the speed up arrow when the Cytospin 4 is switched on at the mains.
- To disable the tune repeat, hold down the speed down arrow when the Cytospin 4 is switched on at the mains.

## Control Keypad

This keypad allows the user to start or stop a run and to switch the instrument into standby mode.

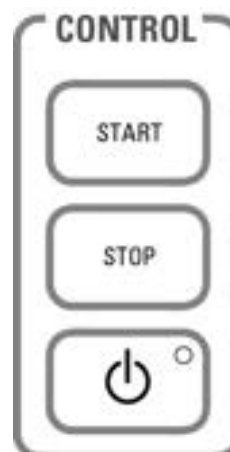

### *Start*

Press [**START**] to begin a run using the parameters selected on the Program Keypad.





### *Stop*

Press [**STOP**] to interrupt the program that is currently running.



### *Standby*

Press [] to switch the instrument into standby mode. The red LED will light when standby is selected and all other displays and LEDs will be turned off.

Press [] again to restart the instrument. The instrument will revert to the previous setup information.



## Status Display

This display area allows the user to see if the lid is locked or open.

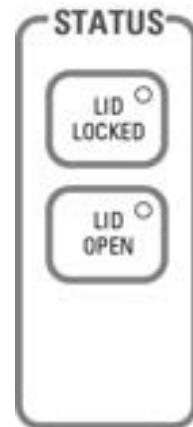

### *Lid Locked*

The LED will light if the lid is locked.

#### **Note**

*The lid is automatically locked during a run.*

### *Lid Open*

The LED will light if the lid is open.



## Chapter 4 – Method of Operation

The Cytospin 4 uses centrifugal force to deposit a monolayer of cells in a defined area on glass slides. It effectively by-passes the difficulties normally associated with depositions obtained by direct smear or filtration.

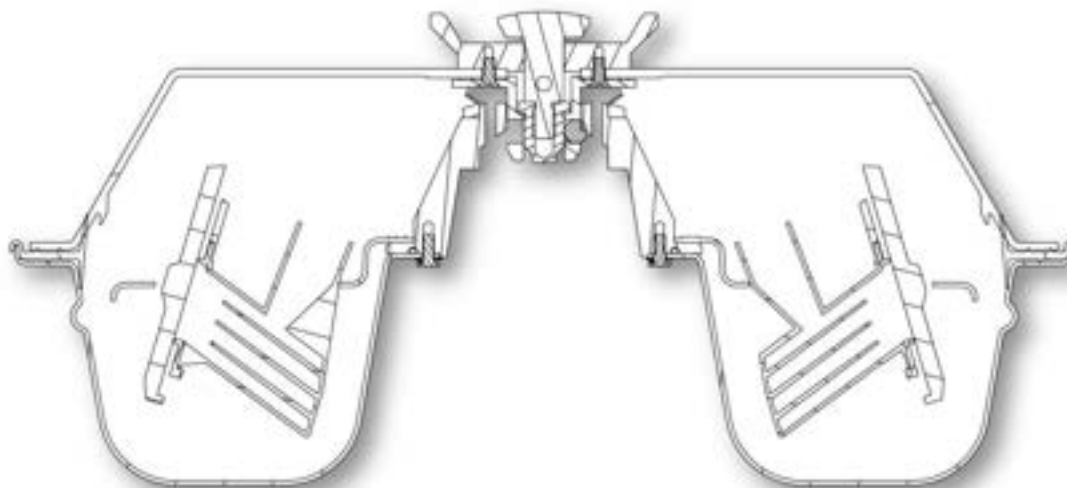

Protection for the operator is offered due to the sealing of potentially hazardous specimens in a sealed head assembly. In addition, individual funnel caps give the user another layer of protection from aerosols. However, Good Laboratory Practice must be used when handling tissue samples to prevent cross contamination and infection. The user should complete a risk assessment to determine any potential hazards related to tissue handling.



Always load and unload the sealed head in a biological safety cabinet. After spinning, take the sealed head to the safety cabinet to open it. This is particularly important if the samples under investigation contain, or could contain, pathogenic micro-organisms.

Pencil marking of frosted end slides is a common method for identifying samples and is a recommended practice that takes into account the expected use of the slide.

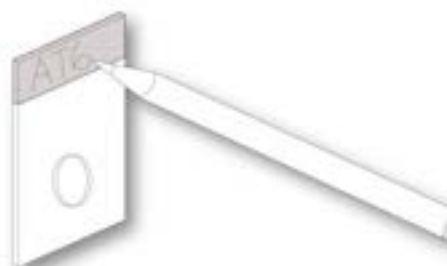

The instrument should be regularly cleaned, disinfected and sterilized as described in [Chapter 5 – Cleaning Maintenance](#).

Each laboratory has its own techniques for preparing cells. The following table - 'Thermo Scientific Cytospin 4 'g' Forces' provides helpful information regarding the forces generated in the Cytospin 4. The 'g' forces quoted apply at the face of the slide that receives the cells.

### Note

*Single user validated procedures are available for guidance upon request from Thermo Scientific. Methodology guidelines are included in [Appendix B](#).*

**Table 1: Thermo Scientific Cytospin 4 'g' Forces**

Speed (rpm)	Force (g)	Speed (rpm)	Force (g)
200	5	1150	149
250	7	1200	163
300	10	1250	176
350	14	1300	191
400	18	1350	206
450	23	1400	221
500	28	1450	237
550	34	1500	254
600	41	1550	271
650	48	1600	289
700	55	1650	307
750	64	1700	326
800	72	1750	346
850	82	1800	366
900	91	1850	386
950	102	1900	408
1000	113	1950	429
1050	124	2000	452
1100	137		

## Operating the Thermo Scientific Cytospin 4

Follow these simple steps to run a program on the Cytospin 4:

1. Load the samples into the sealed head. Fit the lid onto the sealed head and place it in the Cytospin 4. Close the instrument lid.

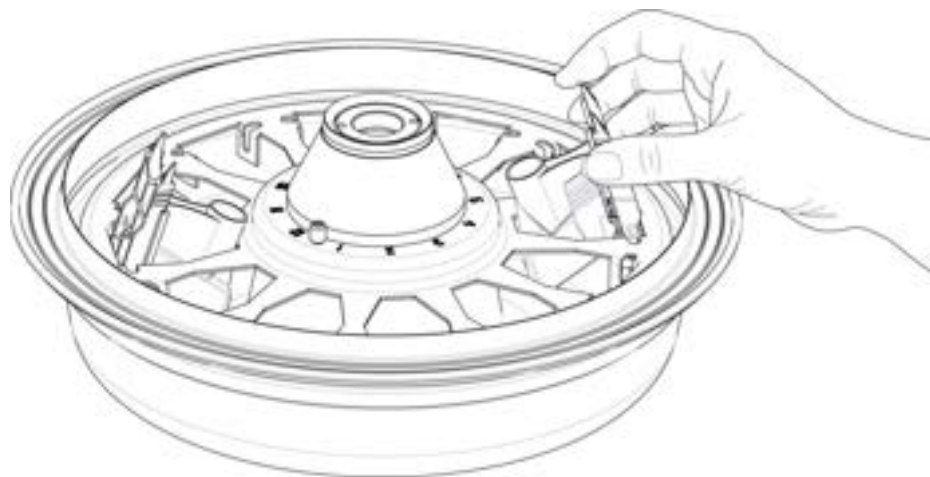

Then, either point 2, followed by point 6:

2. Use the arrows to select an existing program.



Or points 3, 4, 5 and 6:

3. Enter the time required.



4. Enter the speed required.



5. Choose the rate of acceleration required.



Then

6. Press [START] to begin the run.



*The run will stop automatically once the program has finished. However, if it is necessary to stop the run prematurely, press [STOP].*

**Note**

*If you want to save the parameters that have been entered, press [SAVE]. The information will be saved in the program location that is currently displayed (see page 45). Take care - this will overwrite the program information currently saved under that program number.*



## Loading the Cytospin 4

Follow the instructions below to load the EZ Cytofunnel into the Cytospin 4.

### Loading the EZ Cytofunnel

1. Fit the glass slide as shown. Make sure the slide is correctly oriented with the frosted label end to the top and the frosted side towards the EZ Cytofunnel.

EZ Single and Double Cytofunnel

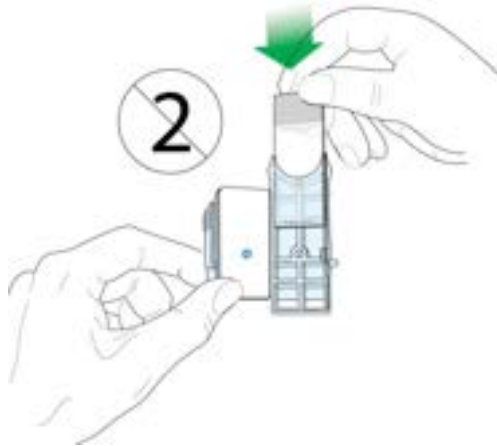

EZ Megafunnel

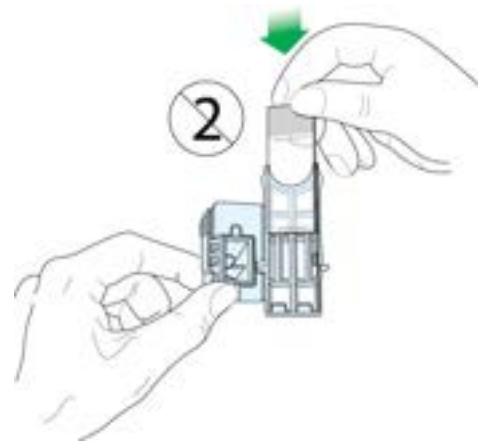

2. To close the EZ Single or Double Cytofunnel, pivot the slide carrier part towards the funnel and press the two halves together. It should close with a positive locking action and an audible click should be heard.



#### Note

*Press on the raised frame around the funnel and not on the funnel itself.*

3. To close the EZ Megafunnel, use both hands. Hold the funnel firmly with one hand and pivot the slide carrier part towards the funnel. Press the two halves together. It should close with a positive locking action and an audible click should be heard.





The Thermo Scientific EZ Cytofunnel has filter cards and gaskets permanently attached to simplify loading and unloading and are designed to be used only once. Please check condition of all Cytofunnels before use.

To remove the slide from the EZ Cytofunnel, press the release lever so that the lock catch is released. Open the EZ Cytofunnel and carefully remove the slide.

- **For EZ Megafunnel only:** pour off any excess fluid.



Discard the EZ Cytofunnel directly into the appropriate waste receptacle depending on the specimens and materials used, according to your local laboratory procedure. Do not use the EZ Cytofunnel more than once.

## Loading the Sealed Head

To load the sealed head, remove the lid and place up to 12 EZ Single, Double or Mega Cytofunnel assemblies into the slots. Make sure the EZ Cytofunnel assemblies are correctly fitted into the sealed head and that they remain tilted forward.



Do not use different types of Cytofunnel in the same sealed head



Always keep the sealed head level when it contains specimens

To avoid an out of balance error (Err 03):

Make sure that the Cytofunnel assemblies are evenly distributed in the sealed head to ensure the sealed head is balanced - for example, place Cytofunnel assemblies into positions 1, 5 and 9 if only three Cytofunnel assemblies are available, or positions 1, 5, 9 and 10 if only 4 Cytofunnel assemblies are available.



### Note

*When an EZ Cytofunnel assembly is placed into the Support Plate in the sealed head, the chamber is kept at a suitable angle to keep the sample away from the filter paper.*

When the Cytospin 4 is started, the EZ Cytofunnels will swing into an upright position that allows the cells to be spun onto the slide.



Make sure that the EZ Cytofunnel assembly is in the rest (tilted) position and carefully load the standard EZ Cytofunnel by pipette with between 0.1ml and 0.5ml (maximum) of cells in suspension (0.5ml - 6ml (maximum) for single and double cytofunnels and EZ Megafunnel.



If specimens have been transported to the laboratory they may be suspended in a suitable fixative such as Thermo Scientific Cytospin Collection Fluid.

See Methodology Guidelines / Fixation or Thermo Scientific Cytospin Collection Fluid Instructions for use.



Do not fill the EZ Cytofunnel with more than the amounts specified below

EZ Single Cytofunnel (white filter card)	0.5ml (maximum)
EZ Single Cytofunnel (brown filter card)	0.4ml
EZ Double Cytofunnel	0.25ml (each side)
EZ Megafunnel	6ml (maximum)

Replace the lid of the sealed head and push down the centre button to lock.



Make sure that the sealed head lid is securely fitted

Open the Cytospin 4 lid (see Chapter 3). Lift the sealed head by the centre knob and carefully place it on the tapered boss in the centre of the Cytospin 4. Close the Cytospin 4 lid.



Use only Cytospin 4 accessories from Thermo Fisher Scientific. Failure to do so may result in unsafe operation and/or give inaccurate diagnostic information.

## Selecting a Program

To select a program, use the arrows to step through the programs that have been saved.

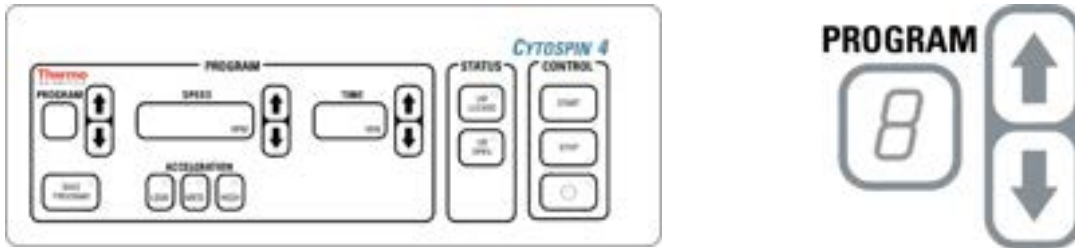

Up to 23 programs can be saved using the following numbers and letters to identify them:

1, 2, 3, 4, 5, 6, 7, 8, 9,

A, c, d, E, F, H, L, n, o, P, r, t, u, y

The settings for each program will be displayed. When the required program is displayed, press [START] to begin.

## Saving a Program

### Note

*An existing program may be overwritten.*

To save a program, select a program number.

Enter the required time, speed and acceleration choices as described in following paragraphs.

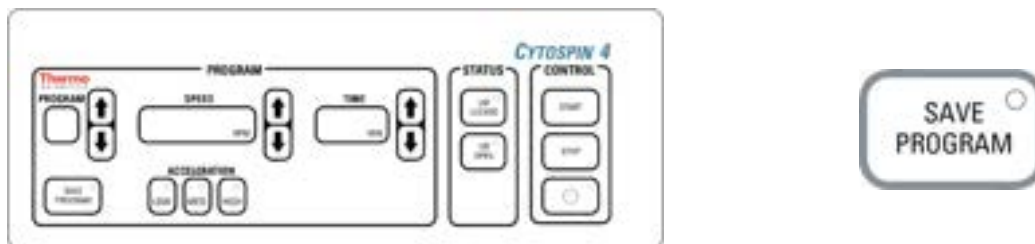

Press [SAVE PROGRAM].

### Note

*The Pull-out Card is intended for you to note down program information for up to 9 programs. Use a water soluble felt pen (supplied with the instrument) to update the program information.*



**Note**

If a program is altered in any way, the LED on the [SAVE PROGRAM] button will flash either until the program is saved, or until another program is selected. Any changes will be lost if the program is not saved.

If the program that is currently displayed has been saved, the LED on the [SAVE PROGRAM] button will remain OFF.

**Entering the Time Required**

To enter the time, use the arrows to alter the display. The display shows the current time in minutes (from 1 to 99 minutes).

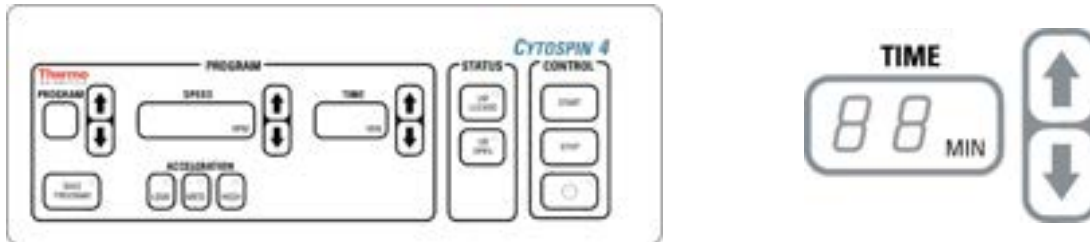

The up arrow increments the time. If it is pressed once, the time will be increased in steps of 1 minute.

The down arrow decrements the time. If it is pressed once, the time will be decreased in steps of 1 minute.

If either button is held down, the time will be incremented or decremented in steps of 10 minutes.



**Maximum run duration for EZ single and double Cytofunnel is 60 minutes**

**Entering the Speed Required**

To enter the speed, use the arrows to alter the display. The display shows the current speed in rpm (revolutions per minute) (from 200 to 2000 rpm).



The up arrow increments the speed. If it is pressed once, the speed will be increased in steps of 10 rpm.

The down arrow decrements the speed. If it is pressed once, the speed will be decreased in steps of 10 rpm.

If either button is held down, the speed will be incremented or decremented in steps of 50 rpm.



**Maximum speed for single and double EZ Cytofunnel is 2000 RPM**



**Maximum speed for EZ Megafunnel is 1500 RPM**

## Entering the Acceleration Required

Press the [LOW], [MED.] or [HIGH] to select the rate of acceleration required. The LED will light to show which rate has been selected.

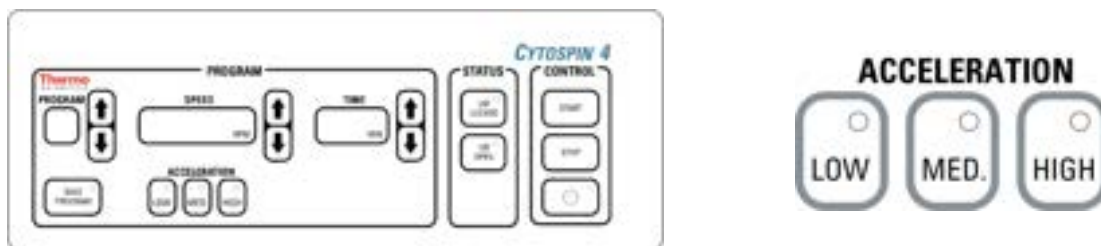

## Starting a Run

Make sure that a correctly balanced head is loaded into the Cytospin 4. Close the lid.

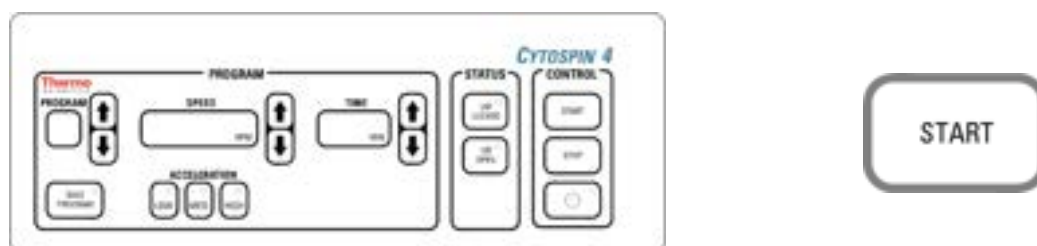

Select or enter the required program and press [START].

The lid will lock automatically and the head will accelerate to the programmed speed. The speed will be maintained for the programmed time and then the head will slow down until it has stopped.

When the head has reached a safe speed (less than 20 rpm) and has almost stopped, the lid will unlock automatically and can be opened.

## Unloading the Thermo Scientific Cytospin 4

To remove the sealed head from the Cytospin 4, allow the instrument to stop spinning. Open the lid and remove the sealed head to a biologically safe cabinet. Only open the sealed head assembly in a biologically safe cabinet.



**Be aware of samples used. They may pose a bio hazard. Use the correct PPE whilst handling biologically hazardous materials.**

**Only open the sealed head assembly in a biologically safe cabinet.**

## Error Codes, Audible Tones and Warnings

If an error occurs while the Cytospin 4 is operating, a warning tone will be sounded and the relevant error code will be displayed in the Speed and Time windows. The error codes are detailed in Chapter 6 – Troubleshooting.

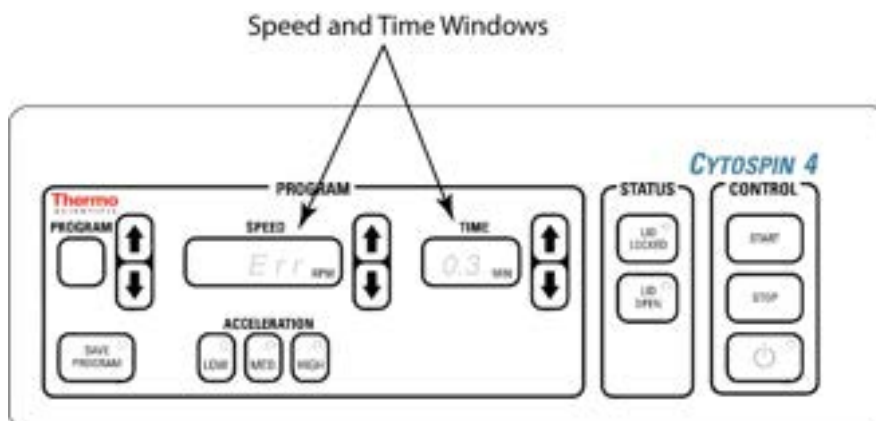

The Cytospin 4 will also play tunes or tones during the normal operation of the instrument, for example when the instrument is switched on, a key is pressed or held down, or at the end of a run.

## Chapter 5 – Cleaning and Maintenance

The Cytospin 4 is designed for easy maintenance and most fixed components such as the lid, the bowl liner, the control panel and the outer housing are cleaned using a proprietary mild detergent solution applied with a soft cloth.

All components and accessories that are likely to become contaminated are also easily cleaned with proprietary mild detergent solutions after decontamination. It is recommended that you follow the suggested methods of decontamination below.

For the continued safe and efficient operation of the instrument, it is important that regular inspection of the instrument during the following cleaning and maintenance procedures is carried out.



If hazardous material is spilt on, or inside, the instrument, the user should carry out the appropriate decontamination (*see world health organisation 'laboratory biosafety manual'*).



Cleaning or Decontamination methods, other than those recommended in the operator guide, should be checked with a Thermo Fisher Scientific representative to ensure that the proposed method will not damage the equipment.



Always wear protective gloves when you clean or decontaminate the Cytospin 4 to protect yourself against infection or the effects of chemicals.



Do not use any chemicals that interact with materials of manufacture. If in doubt, check with Thermo Fisher Scientific Service Department.



Phenol and hypochlorites in strong solution will damage the instrument and its accessories.



Do not use abrasive compounds or metal components to clean the Cytospin 4 or its components and accessories.

Whenever the instrument has been cleaned, make sure that there is a thin film of silicone grease on the side of the drive boss.

The grease helps to make sure that the sealed head sits securely on the drive boss.

If necessary, apply a very small amount of silicone grease (Thermo Scientific part number P01913) onto the side of the drive boss.

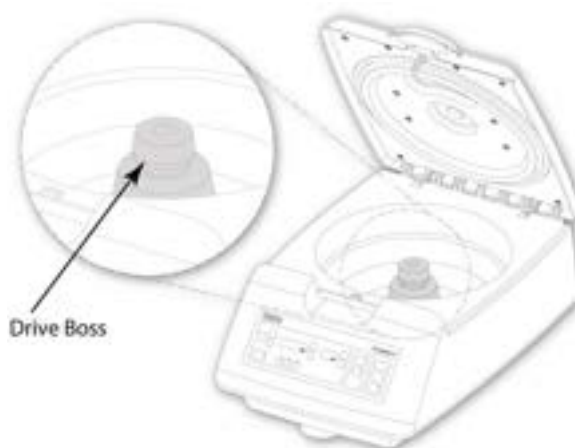

Always wipe up any spills immediately. In the event of a major spillage, disconnect the instrument from the mains supply without delay and do not reconnect and switch on until the instrument has been thoroughly dried out and checked by a service engineer.



Do not use xylene, toluene or any other similar solvent



Most proprietary disinfectants in common laboratory use, such as Clorox®, or commercial disinfectants diluted with 0.3% bicarbonate buffer at 7.0 to 8.0 pH, should be suitable.

Allow disinfectant to contact a contaminated surface for at least one hour, where practicable, to ensure decontamination.



Any accidental spillage of stains on the touch control panel should be removed by immediately wiping with a cloth and a small amount of alcohol



Potentially lethal voltages above 110V a.c. are present inside the unit. Do not remove any access covers

## Routine Cleaning and Maintenance

The following table describes the cleaning instructions for the different areas of the Cytospin 4.



The following instructions are the recommendations of Thermo Fisher Scientific. If another cleaning method is required, please contact Thermo Fisher Scientific.



Remove the mains plug from the supply socket before you clean the fixed components of the instrument

### Front Panel

Frequency	Check	Decontaminate	Clean	Avoid
Weekly or after spillage.			Use warm soapy water on a dampened cloth or sponge. Apply 10% commercial bleach in water on dampened cloth or sponge.	Abrasive powders. Xylene, toluene or similar solvents.

### Lid, Case, Plinth and Bowl Liner

Frequency	Check	Decontaminate	Clean	Avoid
Daily or after serious spillage.	Check that no parts are cracked or damaged.		Use warm soapy water on a dampened cloth or sponge. Apply 10% commercial bleach in water on dampened cloth or sponge.	Abrasive powders. Xylene, toluene or similar solvents.

## Sealed Head Assembly

Frequency	Check	Decontaminate	Clean	Avoid
	It is important that the instructions for the sealed head assembly and sealed head lid and base are followed if the sealed head assembly is to continue to act as an effective biosafety seal			
Daily, if necessary, and immediately after serious spillage.	Check that no parts are cracked or damaged.	Autoclave all the sealed head, its Components and accessories at 121°C (250°F) for 15 minutes. Unlock the lid so that the steam can fully penetrate the Interior.	After autoclaving, wash the sealed head and its Components and accessories in warm soapy water. Dry in an oven at a temperature not exceeding 65°C (149°F). Alternatively, submerge the sealed head base in a 10% solution of commercial bleach in water for no less than 1 hour.	Detergents not suitable for nonferrous metals (for example Decon 90).

## Sealed Head Base

Frequency	Check	Decontaminate	Clean	Avoid
Daily, if necessary, and immediately after serious spillage.	Check that the base is not dented or damaged.	Autoclave at 121°C (250°F) for 15 minutes.	After decontamination, wash the Support Plate in warm soapy water. Rinse in clear water then dry. Alternatively, submerge the sealed head base in a 10% solution of commercial bleach in water for no less than 1 hour.	The use of hard Brushes. Detergents not suitable for nonferrous metals (for example Decon 90).
Weekly.	Remove the silicone rubber lid seal from around the rim of the base and clean the surface of the rim. Replace the seal.			
Annually.	Fit a replacement lid seal.			

## Support Plate

To gain access to the underside of the support plate, undo and remove the two thumb screws, then lift up and remove the support plate.

Frequency	Check	Decontaminate	Clean	Avoid
Daily		Autoclave at 121°C (250°F) for 15 minutes.	After decontamination, wash the Support Plate in warm soapy water. Rinse in clear water then dry. Alternatively, submerge the support plate in a 10% solution of commercial bleach in water for no less than 1 hour.	The use of hard Brushes.

## Sealed Head Lid

Frequency	Check	Decontaminate	Clean	Avoid
Daily, if necessary, and immediately after serious spillage.	Check that the lid is not cracked.	Autoclave at 121°C (250°F) for 15 minutes.	After decontamination, wash the Support Plate in warm soapy water. Rinse in clear water then dry.	The use of hard brushes Abrasive powders, xylene, toluene or similar solvents and detergents not suitable for nonferrous metals (for example Decon 90).
Weekly	Clean the surface of the lid.		Alternatively, submerge the sealed head base in a 10% solution of commercial bleach in water for no less than 1 hour.	
Monthly	Grease the locking ball bearing assembly.			

## Seal Replacement



It is important that the instructions in this chapter are followed if the seals are to continue to form an effective Biosafety Seal

Three flexible seals are fitted in the sealed head - the cone seal, an O- ring seal, and a lid seal.

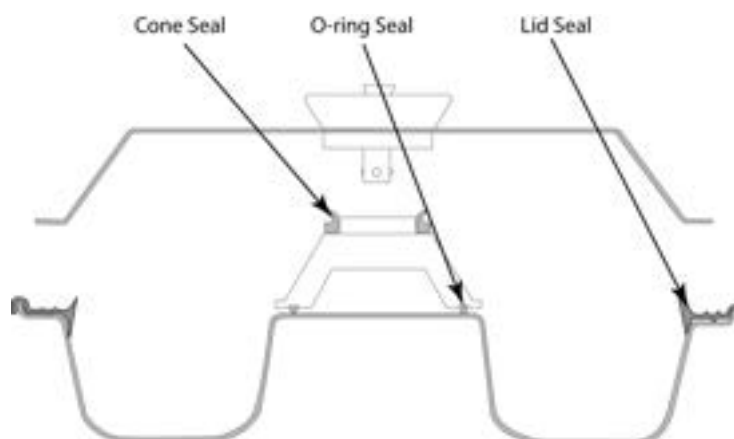

All the seals are designed to withstand normal cleaning and decontamination as part of the routine maintenance of the sealed head. However, the seals eventually become worn, stretched, or degraded by the action of chemicals over a period of time and should be replaced annually.

The three seals are available in sealed head spares kit (Thermo Scientific part number 59910019).

- To remove the sealed head cone seal simply pull the old seal off the cone.
- To fit the sealed head cone seal. Stretch the replacement cone seal, with the thin lip uppermost, onto the collar of the centre cone.

### Cone Seal

To remove the sealed head O-ring seal:

- Use a screwdriver to undo the four screws that secure the cone to the base, then remove the cone and lift the O-ring from its groove.
- To fit the sealed head O-ring seal. Fit a replacement O-ring seal in its groove in the cone.

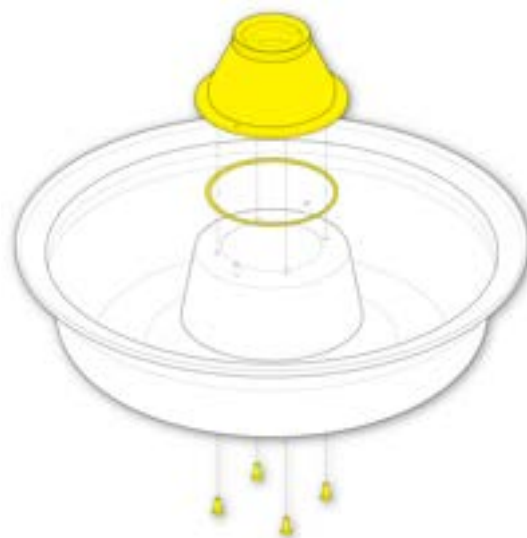

- Make sure that the O-ring fits correctly in its groove then fit the cone to the base. Fit, and then tighten, the four screws.

To remove the sealed head lid seal, pull the old seal off the rim of the base.

## Lid Seal

To fit the sealed head lid seal:

- Place the replacement lid seal on the rim of the bowl then push the lip of the seal over the vertical edge at the periphery of the bowl (see lid seal cross section diagram below).
- Make sure that the seal fits uniformly around the rim.

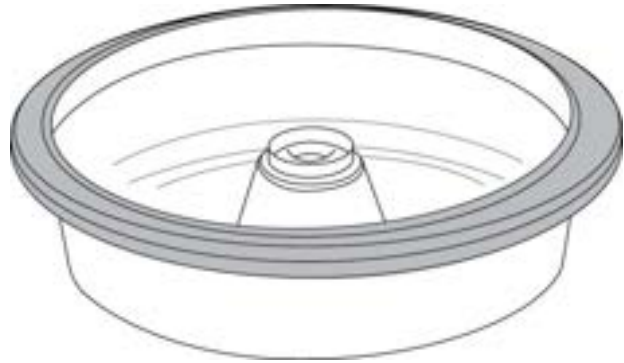

*Lid Seal Cross Section*

## Chapter 6 – Troubleshooting

Correct service and maintenance is essential for the long term serviceability of precision engineered products such as Cytospin 4. We strongly recommend that a Thermo Scientific Service Contract is obtained to ensure future reliability, and consistency of performance.

- Table 1 shows remedial action to be taken if Cytospin 4 fails to operate.
- Table 2 details the error codes and the actions required to clear the errors.
- Tables 3 to 6 relate to processing problems and suggested solutions with respect to the preparation of cells by cyto-centrifugation.



Be aware of samples used. They may pose a bio hazard. Use the correct PPE whilst handling biologically hazardous materials

### Table 1 – Instrument Function

Symptom	Cause	Remedy
Displays not lit on control panel	No power supply	Check the mains supply
	Fuse blown in plug	Replace the mains fuse
	Instrument fuse blown	Replace the instrument fuse <b>Note</b> <i>Only a technically competent person should replace fuses</i>
	Instrument is in standby mode - red LED is on	Press 
Programs do not run	Stopped at instrument	Press <b>[START]</b>
	Incorrect programming	Check ranges: 200 -2000 r.p.m. 1 - 99 minutes
	Lid not closed	Close lid

### Error Codes

Audible warning tones will sound and error codes will be displayed if the Cytospin 4 detects a situation that prevents it from working safely and efficiently.

The speed and time windows will display Err 0X where X is the error number detailed in Table 2. For example, Error 3 would be displayed.

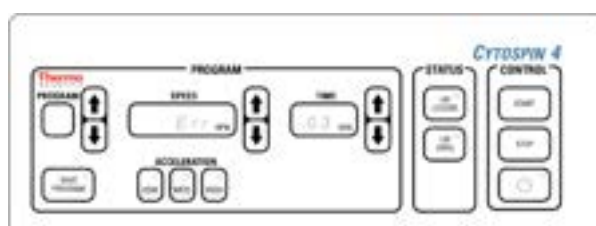

To clear an error, press **[STOP]** to silence the alarm. When the sealed head has stopped spinning, press **[STOP]** again to clear the error. When an error has been cleared, the lid of the instrument must be opened and closed.

If an error code is displayed that is not listed in Table 2, turn the instrument off and then on again to clear them.

If any error does not clear, contact the Thermo Scientific Service department.

**Table 2 – Error Codes**

Error Code	Cause	Remedy
Err 01	Lid Error - the lid switch has not operated correctly.	Press [STOP], then open and close the lid
Err 02	Speed Error - the Cytospin 4 cannot currently maintain the normal tolerance of $\pm 20$ rpm, or has been unable to reach the programmed speed within 1 minute	Press [STOP], then open and close the lid
		Check that the sealed head is installed correctly and turns freely
		Contact Thermo Scientific Service department if problem persists
Err 03	Out of Balance Error – the Cytospin 4 detects that there is a balance error	Turn the Cytospin 4 off and then on again, then open and close the lid
		Check sample carrier distribution
		Check sealed head for damage
		Check that the sealed head turns freely
Err 04	The battery has discharged or the system memory has been corrupted which has reset the instrument	Press [STOP], then open and close the lid
		Leave instrument switched on for 24 hours Contact Thermo Scientific Service if the problem persists
Err 05	Lid Lock released manually during run or the lid solenoid has not operated correctly	Press [STOP], then open and close the lid
Err 06	Lid was not opened and closed when the power switched on or after an error	Press [STOP], then open and close the lid

**Table 3 - Unsatisfactory Cyto centrifugation Results – Quality**

<b>Problem</b>	<b>Cause</b>	<b>Remedy</b>
<b>Before Cyto centrifugation</b>		
Poorly preserved cells	Preserved poorly in vivo	Request repeat specimen
	Lengthy delays between collection and preparation	Minimize delays (e.g. less than 4 hours. Refrigerate if longer)
	Cells suspended in normal saline	Use balanced electrolyte solution
Cells small in diameter; optically dense	Cells collected in high proportion of strong alcohol	Collect unfixed fresh specimens, or mix with equal volume of 50% ethanol
	Alcohol added to sample chamber begins to rise through the cell suspension and causes cell shrinkage when it mixes	Add less alcohol; add alcohol carefully
RBCs haemolysed; ghosts remain	Alcohol was mixed with cell suspension	Add alcohol carefully to sample chamber
<b>During Cyto centrifugation</b>		
Cells air dried	Cell suspension medium absorbed completely by filter card	Fill cylindrical sample chamber before Cyto centrifugation; use Thermo Scientific Cytospin 4 Collection Fluid; reduce the Cyto centrifugation time and/or speed
Cells air dried around periphery of collection area	Cell suspension medium almost completely absorbed by filter card	Increase specimen volume up to 0.5ml; use Thermo Scientific Cytospin 4 Collection Fluid; reduce Cyto centrifugation time and /or speed
<b>After Cyto centrifugation</b>		
Cells air dried	Film of liquid over the cells allowed to evaporate during brief interval between unloading and immersion in alcohol	Move quickly to avoid evaporation of protective film from over the cells
Cells air dried around periphery of collection area	Film of liquid is thinnest at its edges and evaporates before the thick central area	Immerse cells in alcohol before air drying progresses on to periphery of cell area
Disrupted air dried pale cells, resemble 'basket cells' of haematology	Fragile cells air dried and exaggerated by centrifugal force	Request repeat specimen. Do not allow to air dry



**Table 4 - Unsatisfactory Cytocentrifugation Results – Quality**  
(Number of Cells)

Problem	Cause	Remedy
<b>Before Cytocentrifugation</b>		
No cells	Exit port blocked by filter card (TPX funnels only)	Request repeat specimen
Abnormal cells in specimen but not on cytocentrifuged preparations	Abnormal cells, usually larger and heavier than normal cells, sediment to bottom of concentrate. May be missed if not re-suspended completely following conventional centrifugation	Apply centrifuge tube with cell concentrate and several ml of balanced electrolyte solution to vortex mixer and completely re-suspend cells
Too few cells	Too few cells in raw specimen	Enrich by conventional centrifugation. Re-suspend cells in 1-2ml balanced electrolyte solution. Combine contents of multiple centrifuge tubes of same specimen when possible. Microscopically examine drop of re-suspended cell concentrate; Base sample size on cell count. Request repeat specimen; suggest ways to increase cellular harvest
	Too few cells added to sample chamber	Base sample size on cell count of drop of re-suspended cell concentrate
	Sparsely populated specimen may have filled the cylindrical and conical portions of the sample chamber	Enrich specimen as described above
	Partially filled cone raised level of specimen in cylinder to filter card level where cells can be absorbed	Do not allow distal boundary of specimen to touch filter card before cyto-centrifugation
	Cells crowded out by precipitated hyaluronic acid in joint fluid	Dissolve hyaluronic acid precipitate with pinch of hyaluronidase
	Cells crowded out by precipitated phosphate salts in urine	Mix several drops of glacial acetic acid to lower the pH and re-dissolve the alkaline pH dependant precipitated phosphate salts
	Cells crowded out by erythrocytes	Use saponin to haemolyse erythrocytes
	Slide is between exit port and filter card (TPX only)	Load in correct sequence; sample chamber filter card side
Too many cells	Too much densely populated cell suspension added to sample chamber	Microscopically examine drop of re-suspended cell concentrate; dilute up to 10x if necessary; base sample size on cell count or derive it from haematological counting chamber. Do not rely on visual estimates of specimen appearance

<b>During Cytocentrifugation</b>		
Too few cells	Exit port blocked by misaligned filter card (TPX only)	Check alignment as seen through window from back of slide clip; seat filter card
	Cells lost through gap between exit port and filter card	Unlikely; though check assembled unit for alignment
<b>After Cytocentrifugation</b>		
Too few cells	Suspension medium absorbed incompletely as a result of filter card becoming clogged by debris in previously non-centrifuged specimen and / or pores collapse from too much pressure from spring or excessive centrifugal force	Centrifuge specimen at 3000 r.p.m. for 10 min. to sediment cells and leave debris in suspension to be discarded with supernatant. Do not wet blotter before Cytocentrifugation. Cytocentrifuge specimen at 1000 rpm for 6-10 min
	Unabsorbed suspension medium can induce cell wash-off	Unload horizontal sample chamber, cell side up. Allow blotter to absorb excess liquid. Lift chamber and blotter away from slide. Lay slide flat until a thin film remains; immerse in fixative

**Table 5 – Unusual Pattern of Cell Population Distribution**

<b>Problem</b>	<b>Cause</b>	<b>Remedy</b>
<b>Before Cytocentrifugation</b>		
Crescent shaped distribution	Cylinder filled incompletely	Fill cylinder completely
	Cells settle in cylinder if prolonged delay before Cytocentrifugation	Rapidly load sample chambers and begin Cytocentrifugation immediately
Display area displaced from label end	Slide not seated to foot of Cytofunnel	Seat slide to foot of Cytofunnel
Display area displaced towards label end	Slide placed in Cytofunnel label end down	Insert slide label end up
Cells on underside of slide	Slides loaded backwards	Orient slide with label facing exit port
<b>After Cytocentrifugation</b>		
Cell population streams towards label end or to opposite end	Thinly layered cells too wet and are either pushed up the slide upon immersion in alcohol, or slide down the slide following immersion	Let the suspension medium evaporate almost completely
Circular band of cells, a cellular centre, 'Bull's Eye' distribution	Thickly layered cells, margins nearly dry but centre remains very wet and promotes cell wash-off	Add less cell suspension

## Table 6 – Summary

To predictably produce cytocentrifuged preparations that exhibit within a 28mm<sup>2</sup> circle a representative sample of randomly distributed, un-crowded, mono-layered, flattened cells that are well preserved and displayed, the materials and methods that follow are recommended:

<b>Before Cytocentrifugation</b>	
<b>Do</b>	<b>Do Not</b>
Use unfixed fresh cell suspension	Use cell suspensions collected in alcohol
Saponinize bloody cell suspensions	Use bloody cell suspensions
Equalize differences in cell suspension	Thermo Scientific Cytospin 4 un-processed cell suspensions
Control the number of cells	Estimate number of cells
Use clean Micro slides	Use frosted or albumenized micro slides
Use balanced electrolyte solution	Use normal saline
Keep cell suspension from the filter card	Let the cell suspension touch the filter card
Fill sample chambers with similar volumes	Use significantly different volumes
<b>During Cytocentrifugation</b>	
<b>Do</b>	<b>Do Not</b>
Select a speed, time and acceleration suitable for the specimen type, for example, use lower speeds and acceleration for fragile cells	Centrifuge too rapidly
	Centrifuge too briefly, or for too long
<b>After Cytocentrifugation</b>	
<b>Do</b>	<b>Do Not</b>
Keep the cells slightly wet	Allow the cells to air dry unless intended
Immerse immediately the cytological preparation in 95% ethanol for ethanol preps	Let too much liquid remain on the cells
Allow the cellular monolayer to air-dry before staining when using Thermo Scientific Cytospin 4 Collection Fluid	Immerse in 95% ethanol until the cell mono-layers prepared with Thermo Scientific Cytospin 4 Collection Fluid have dried sufficiently - unless otherwise specified

## Chapter 7 – Spares and Accessories

Centrifuge Accessories	Quantity	Part Number
Sealed Head (not including Cytofunnels)	single	59910018

Centrifuge Spares	Quantity	Part Number
Sealed Head Seals	pack of 3	59910019
<p><b>Note</b>  <i>Each sealed head requires 3 different seals - this pack includes one of each type of seal required.</i></p>		
Support Plate	single	59920047



Use only Thermo Scientific Cytospin 4 accessories from Thermo Scientific. Failure to do so may result in unsafe operation and/or give inaccurate diagnostic information

Other Accessories	Quantity	Part Number
<b>Sample Chambers:</b>		
Thermo Scientific EZ Single and Double Cytofunnels: (disposable; integral filter cards; packs include caps)		
Single, white filter card	pack of 50	A78710003
Single, brown filter card	pack of 50	A78710004
Double, white filter card	pack of 50	A78710005
Thermo Scientific EZ Megafunnel - 6ml (includes caps and slides)	pack of 25	A78710001

Other Accessories	Quantity		Part Number
<b>Cytoslides:</b>			
76 x 26mm glass slides with outlined specimen area and frosted area at one end for identification			
Single circle	coated	circle on back	pack of 100 5991056
Single circle	non-coated	circle on back	pack of 100 5991051
Single circle	non-coated	circle on front	pack of 100 5991059
Double circle	coated		pack of 100 5991055
Double circle	non-coated		pack of 100 5991054
Megafunnel slide	coated	rectangle	pack of 25 5991026
Double circle	blue mask		pack of 100 B5991050
Single circle	black mask		pack of 100 5991057

Other Accessories	Quantity	Part Number
<b>Preparation:</b>		
Thermo Scientific Cytospin 4 Collection Fluid		
10 litre bottles	pack of 2	9990310
4 litre bottle with pump	single	6768001
500 ml bottles	pack of 2	6768315
120 ml cups (filled to 60 ml)	pack of 125	9990323
CytoRich Red Collection Fluid		
4 litre bottle	single	B9990800
500 ml bottles	pack of 2	B9990801
120 ml cups (filled to 60 ml)	pack of 125	B9990803
20 ml vials (filled to 10 ml)	pack of 180	B9990802
Mucolexx Transport Fluid		
4 litre Bag-In-A-Box	single	9990371
500 ml bottles	pack of 4	9990370
120 ml cups (filled to 60 ml)	pack of 50	9990375
Thermo Scientific Cell-Fixx Spray Fixative		
50 ml spray bottle	pack of 6	6768326
Service Manual	single	A78310251
Silicone grease (for drive boss)	60g tube	P01913
Standard Workflow Diagram Card	single	A783-1001
Water soluble felt pen	single	A78330031
Papspin Collection Fluid		
500 ml bottles	Pack of 2	6768350

For more details, please refer to the latest catalogue.

## Appendices

### Appendix A – Standard Workflow Diagram

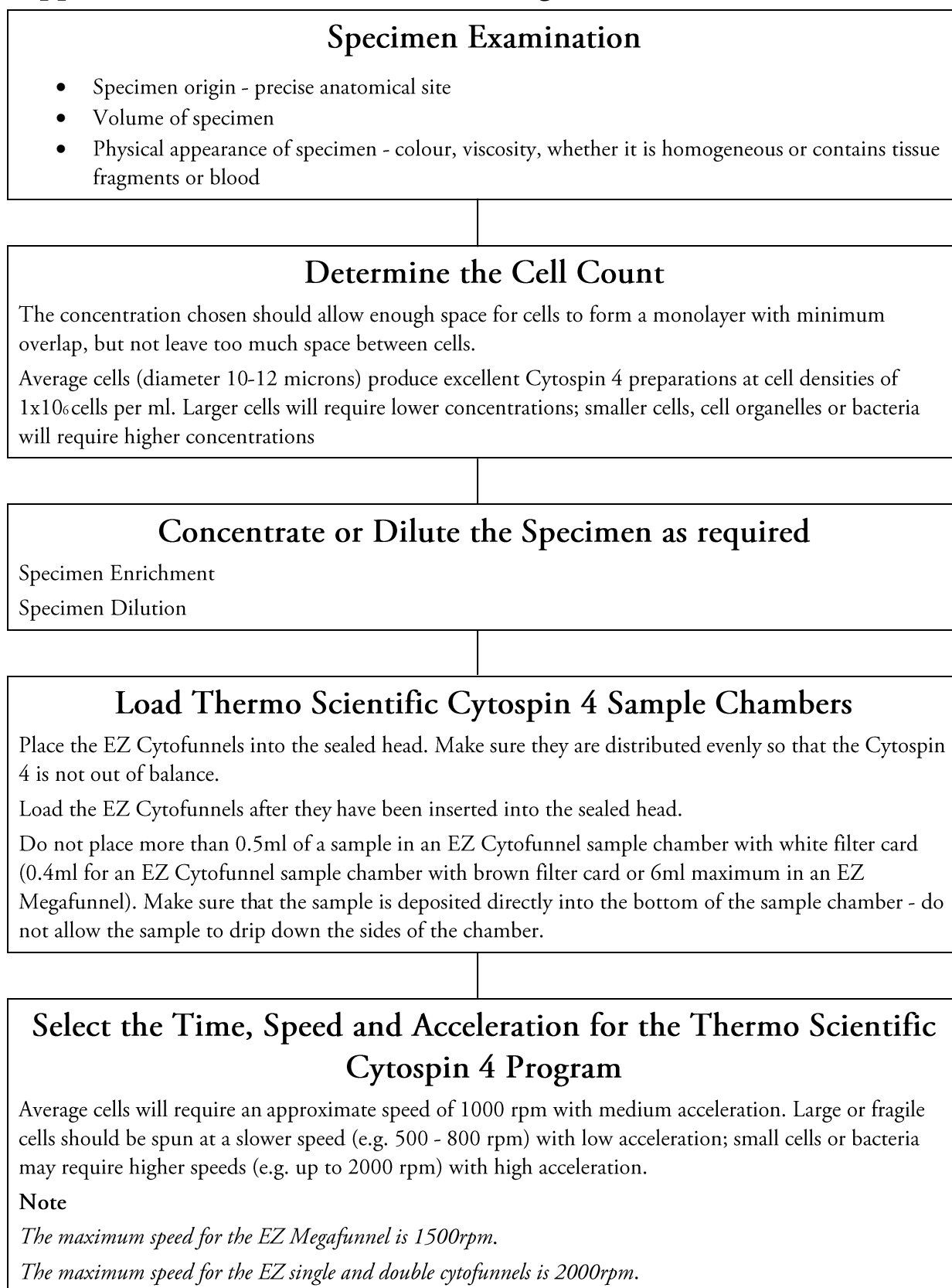

## Run the Thermo Scientific Cytospin 4

When the Cytospin 4 is programmed and the sealed head is loaded, press [START] to start the run.

## Unload the Cytospin 4 Sample Chambers

The Cytospin 4 lid will unlock automatically as soon as the Cytospin has stopped spinning.

As soon as possible after the Cytospin 4 has stopped spinning, remove the sealed head from the instrument and open it in a biological safety cabinet.

Open the sealed head lid and remove the EZ Cytofunnel assemblies.

## Fixation

Fix the samples as soon as possible to avoid autolysis.

## Staining

The specimen can now be stained and examined according to laboratory procedures and examined microscopically.

## Microscopy and Diagnosis



Be aware of samples used. They may pose a bio hazard.

## Appendix B – Methodology Guidelines

### General Theory – Introduction

The Thermo Scientific Cytospin 4 is a special purpose instrument designed to deposit cells on to glass slides. The instrument produces monolayer cell deposition in a defined area of the slide, using centrifugal force. For most cytological specimens the Cytospin 4 offers significant advantages in specimen retention, preparation, and standardisation, and ease of specimen evaluation.

Cytological specimens may also be deposited on to slides by techniques such as direct smears or by filter techniques. While useful with some specimens, both direct smears and filter techniques have significant disadvantages when compared with Cytospin 4 preparations.

Direct smears consistently produce preparations of varying thickness from end to end of the smear. In addition, severe mechanical damage may result in too many cells within the preparation. There is also a likelihood of selective cell distribution within the smear. Cells of different sizes will be deposited in different areas of the smear.

Filter preparations, while excellent for cell retention, are technically demanding and time consuming. In addition, filter preparations rarely yield slides that can be evaluated easily. The cells are seldom in the same plane as the focus within the microscope, and it is extremely difficult to obtain well stained cells without also staining the filter. For those filter techniques that dissolve the filter, there is a significant risk of cell loss, in addition to the difficulty and hazards of using a volatile and dangerous solvent.

Cytospin 4 preparations effectively circumvent these difficulties, producing uniform preparations of cells that are easily stained and evaluated. In addition, the construction of the Cytospin 4 allows maximum containment of potentially hazardous specimens, thereby reducing the risk to laboratory personnel.

Specimens from body fluids and all body sites can be used for Cytospin 4 preparations. The primary requirements are that the specimen be a cell suspension, preferably of single cells, and that the cells are fresh and intact enough to yield diagnostic information. With proper application of the general principles of Cytospin 4 operation, consistent preparations of well-preserved cell mono-layers should result.

### General laboratory Considerations

The Cytospin 4 is designed to provide maximum protection to the operator by completely containing potentially hazardous specimens. However, Cytospin 4 cannot protect the operator during the various steps required to process a specimen prior to using the Thermo Scientific Cytospin. Good laboratory practice requires the use of a biological safety cabinet for all manipulators of cytological specimens. This includes both the loading and unloading steps for the Cytospin 4. Once the specimen is loaded into the Cytospin 4 sealed head, and the lid is sealed in place, the sealed head may then be taken outside the biological safety cabinet for spinning in the Cytospin 4. After the Cytospin 4 has stopped, the sealed head should be returned to the biological safety cabinet prior to being opened.



Due to the potentially infectious nature of the specimens that may be processed in the Cytospin 4, the laboratory must establish procedures to ensure that the instrument is routinely disinfected. Suggested methods for cleaning and disinfecting of the Cytospin 4 and accessories will be found in the Cleaning and Maintenance section of the Operator Guide. As with all clinical specimens, it is extremely important to maintain specimen identification. For the Cytospin 4, this means that the slides on to which a specimen will be deposited must be adequately labelled with the appropriate specimen identification. The method of labelling must take into account the subsequent procedures that will be used. In general, it would be expected that the label might be subjected to fixation steps and staining procedures. Obviously, a paper label would be inappropriate. Pencil identification on frosted-end glass slides is the most common approach to specimen identification.

The laboratory must also ensure that adequate labelling is maintained for all containers or devices to which the specimen is transferred. In use of the Cytospin 4, this may include one or more centrifugation steps, conducted in a standard laboratory centrifuge. Each new container to which the specimen is transferred must be appropriately labelled. In addition, the laboratory must ensure containment of the specimen to eliminate potential hazards to the laboratory personnel. Since most centrifuges do not provide aerosol containment during operation, any intermediate centrifugation steps should be conducted in a biological safety cabinet. At the conclusion of specimen preparation, all intermediate containers, pipettes, etc., should be disposed of in an appropriate biohazard container.

## Specimen Preparation

### Initial Examination

Cytological examination always begins with a macroscopic examination of the specimen at the time it is submitted to the laboratory. This is a crucial examination, as it provides information that will be used to select processing protocol. The macroscopic examination is most useful in the hands of an experienced technologist. Prior experience with a particular specimen is invaluable in recognising whether a given sample is normal or highly suspect, and whether the specimen will be adequate for cytological examination. However, it is usually impossible to determine if a given sample contains abnormal cells from the macroscopic examination only. A specimen which should normally be clear should not be assumed to be abnormal simply because it is bloody on arrival in the laboratory. Any number of circumstances may produce a different appearance in a specimen during the collection process.

The macroscopic examination cannot be used as a definitive test of the specimen. It does serve to support the eventual diagnostic assessment, but more importantly, it provides the information that will allow the technologist to choose a specimen preparation protocol. A complete macroscopic examination may include:

1. Record of specimen origin - precise anatomical site.
2. Volume of specimen.
3. Gross characteristics.

Gross characteristics describe the physical appearance of the specimen. Important parameters are the colour of the specimen, its viscosity, and whether the specimen is homogeneous or contains solid tissue fragments.

The gross examination will also determine if the specimen is fresh or if it has been fixed prior to delivery to the laboratory. In general, it is preferable if all cytological samples are submitted to the laboratory in the fresh state. However, in many cases, due to transport distances or time constraints, the specimen will be fixed prior to submission. This must be noted during the gross examination, as fixation may affect several of the parameters recorded during the gross examination. Prior fixation may also constrain the subsequent processing of the specimen. Fixation and its effects will be discussed in a subsequent section of this paper.

## Determination of Cell Number

Successful operation of the Cytospin 4 requires knowledge of the number of cells present in the sample. While the experienced technologist will achieve reasonable results by estimating the cell number, less than optimal preparations sometimes result from such estimates. It is highly recommended that all specimens be examined specifically to determine cell numbers. Visual appearance alone is often confusing, since specimen turbidity may be the result of cell debris, suspended lipids, or other non-cellular materials. In such cases, a direct determination of cell number is necessary to ensure proper Cytospin 4 preparations.

Samples which contain 'average' cells, that is cells with an approximate diameter of ten to twelve microns, produce excellent Cytospin 4 preparations at cell densities of one million cells ( $1 \times 10^6$ ) per ml. Specimens containing large cells require lower cell concentrations, and specimens with tiny cells, cell organelles, or bacteria, may require higher concentrations. The absolute concentration required will be somewhat dependent on the processing methodology employed. As a general rule, the concentration chosen should be such that the cells within the sample have adequate space to spread into a monolayer on the slide surface, with minimal overlap, or piling up of cells. Ideally, the concentration should be high enough that there is not too much space between cells. Having sufficient concentration of cells speeds up evaluation of the preparation, since little time will be lost in searching for cells to evaluate.

A quick method for approximating the number of cells present in a sample is to place a single drop of the sample on a slide and cover with a 24 x 50 mm coverslip. By lowering the condenser of the microscope, or by closing the microscope condenser diaphragm, the unstained cells can be seen (although detail will not be seen). Using the 10 x objective, scan the field and pick an area that appears about average for the entire slide. The cells will mostly likely not be evenly spread, which is why it is necessary to select an average area. Now switch to the 40 x objective. You may also need to open the diaphragm or raise the condenser slightly.

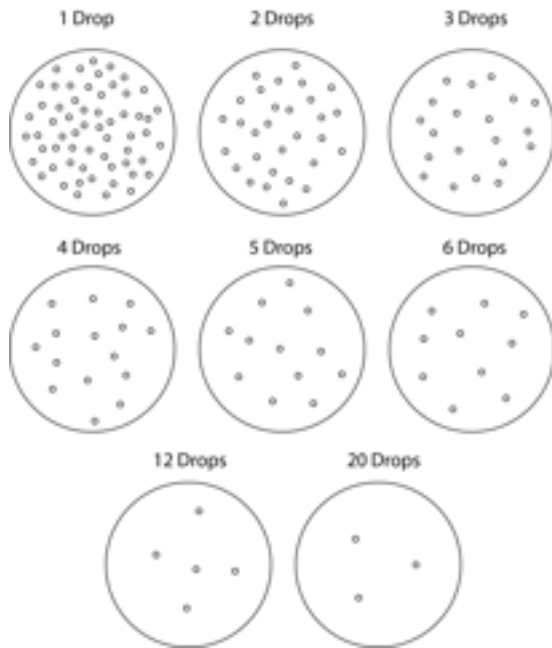

The large circles represent cells in one drop of cell suspension, either of unprocessed cell specimens or preferably of centrifuged cell concentrate, that have been spread under a 24 x 50 mm cover glass and viewed under a 40x objective.

Although drawn smaller than they appear microscopically, the cell and field diameters are proportional to one another at a 50:1 ratio. Simply match the microscopic field with its closest counterpart here and use the number of drops so indicated.

### **Cells / 40x field as a guideline to the number of drops of cell suspension / Thermo Scientific Cytospin 4 sample chamber**

Count the cells seen in the field. It is not necessary to count every cell - an approximation will do. Refer to the illustration *Cells / 40x field as a guideline to the number of drops of cell suspension / Cytospin 4 sample chamber*. This count can be used to estimate the number of drops of the cell suspension required for a Cytospin 4 preparation. To determine the number of cells being used, multiply the number of cells counted by 38. Divide the number of cells counted into 60. The quotient equals the number of drops that should be added to the Cytospin 4 sample chamber, though the total volume should not exceed the 0.5 ml capacity of the chamber. This gives the total number of cells applied to the Cytospin 4 funnel for each drop of suspension used. While this technique for estimation of cell number is an approximation only, it does provide an excellent control of Cytospin 4 preparations.

A second method of cell number determination is by manual counting of cells in a haemocytometer. This is a device that defines a precise volume between a special glass slide and a coverslip. By counting the total number of cells within this volume, the cell concentration within the specimen can be accurately determined. While more accurate than simply using a coverslip on a standard slide, the extra precision of this method is not usually required for successful Cytospin 4 preparations.

A third method for determination of cell number is by use of a cell counter of the electronic volume sensing type (Coulter counter). This instrument can provide a precise evaluation of a cell sample. It does require sufficient amount of sample however, which may not always be available. It is common to determine the cell number of specimens using this instrumentation in the haematology laboratory. Any specimen obtained from the haematology laboratory may include cell number (or concentration) information.

It is important to recognise that samples that are quite concentrated should be handled carefully. For example, if the specimen is so concentrated that only a single drop may be required, the addition of a

second drop will double the cell concentration. It is preferable to work with specimens that are dilute enough that five or six drops are required for the preparation. With such a specimen, the addition of one more drop will not be as likely to result in overlapping cells in the final Cytospin 4 preparation.

While it is common to discuss sample sizes in terms of 'drops', it is important to realise that drop size will be dependent on the type of pipette used to transfer the specimen. As an example, a Falcon 3 ml transfer pipette will dispense approximately 0.5 ml in 15 drops. A six inch glass Pasteur pipette will dispense 0.5 ml in 20 drops. It is advisable to standardise on a single pipette type for all cytological preparations, otherwise 'drops' will be a meaningless measurement.

## **Specimen Enrichment**

Many cytological specimens arrive in the laboratory as relatively large fluid volumes, many with relatively few cells. Such specimens must obviously be concentrated prior to use of the Cytospin 4. Such concentration requires the use of a general laboratory centrifuge. The amount of the specimen submitted will determine the size centrifuge tubes that will be necessary. In some cases, the original specimen may need to be split between many tubes. As an example, if a centrifuge is available which can hold 50 ml tubes, and the total amount of specimen is 100 ml or less, then two tubes can concentrate the entire specimen. Should the specimen amount to 150 ml, then four tubes would be required. By adding more tubes it is possible to concentrate specimens which are quite large in volume. To sediment the cells, the centrifuge should be spun at 2000 to 3000 rpm for 10 to 20 minutes. Avoid spinning at excessive speeds. This will only damage cells, and pack them into such tight buttons they will be difficult to process further. Centrifuges with swinging buckets will generally require slightly higher speeds than angle headed centrifuges.

After conventional centrifugation, any cells present in the sample would appear as a packed button in the bottom of the tube. The clear supernatant above the cell button should be carefully aspirated or poured off, leaving a volume of fluid approximately equal to the volume of the packed cell button. The fluid that is aspirated or poured off may be discarded, using any common technique to render it harmless (sterilisation, fixation etc). This fluid should only be discarded after it is determined that the cells within have indeed been retained.

The packed cell button in the bottom of the centrifuge tube should be thoroughly mixed with the residual fluid that was not removed. This is done either by use of a vortex mixer, or by gentle agitation of the tube. The result is a concentrated cell suspension, suitable for cell number determination, and subsequent preparation with the Cytospin 4.

## Specimen Dilution

Cytology specimens often are submitted to the laboratory with a cell concentration that is too high for Cytospin 4 preparations until diluted. Such specimens are common from bone marrow, lymphoid aspirates, and many fine needle aspirates. These concentrated specimens should first be evaluated for cell number, using any of the previously described techniques. The specimen should then be diluted to an approximate cell concentration by addition of a balanced electrolyte solution. It is important to use a fluid that has a proper osmolarity, in order not to introduce structural changes in the cell sample. Simple solutions of Sodium Chloride (0.9% saline) are unsuitable as diluents - they produce rapid changes in nuclear chromatin and interfere with subsequent cytological evaluation.

Many of the solutions commonly used in tissue culture laboratories are suitable diluents, such as Earle's balanced salt solution, or Hank's balanced salt solution. In many cases, if the cell suspension submitted to the laboratory has been collected in one of these diluents, or has undergone significant processing in such salt solutions, it may be advisable to add some protein to the diluent. Either human serum or a solution of bovine serum albumin may be used. The usual concentration of these solutions is 1 to 30 percent. The protein solutions of very high concentration are usually used by dropwise addition to the sample just prior to or during loading of the Cytospin 4 funnels.

## Loading the Thermo Scientific Cytospin 4 Sample Chambers

The sample chambers hold a maximum of 0.5 ml of specimen and should hold no less than 0.1 ml. Do not place more than 0.5 ml of sample in each standard EZ Cytofunnel sample chamber (up to 6ml for EZ Megafunnels).

Additional sample would simply be thrown to the top of the chamber during Cytospin 4 operation, and could not be deposited on the slide. It is recommended that the sample chambers are loaded after they have been assembled and inserted into the sealed head. The design of the chamber assemblies and the sealed head ensures that the sample chambers tilt in such a manner that the specimen will not contact the slide or the filter card prior to starting the Cytospin 4. The specimen must never contact the slide or filter before the Cytospin 4 is started.

The operator must be careful during loading not to forcibly inject the sample into the sample chamber. The sample should be eased into the sample chamber slowly, allowing ample opportunity for air to be displaced by the sample.

For concentrated cell suspensions which require only one or two drops of sample to obtain the correct cell concentration, it may be sometimes necessary to add additional diluent to bring the total volume in the sample chamber up to 0.5 ml. This addition can be done in the chamber as the samples are loaded. However, this requires care to avoid forcing sample into the slide / filter area and it is recommended that 'thick' specimens are diluted prior to being loaded into the Cytospin 4.

During loading of the sample chamber, the sample should be deposited directly in the bottom of the sample chamber. Avoid dripping the sample down the side of the sample chamber. Should sample be deposited on the walls of the chamber, rinse down with a drop of diluent. The object is to ensure that the entire sample is in the bottom of the sample chamber.

## Selecting Time, Speed and Acceleration

The speed of operation of the Cytospin 4 is dependent on the size of the cells or particles to be deposited on the slides. In general, average cellular specimens will require a speed of approximately 1000 rpm with medium acceleration. Very large cells or fragile cells may require a slower speed, such as 500 to 800 rpm with low acceleration.

Specimens consisting of tiny objects such as bacteria may require much higher speeds, approaching 2000 rpm with high acceleration.

Time of Cytospin 4 operation is also related to specimen type and to subsequent preparative steps. For most cytological preparations, it is desirable to avoid any possibility of air drying of the specimen. Therefore the time used for Cytospin 4 operation is kept as short as possible, such as 3 to 4 minutes. For haematology and microbiology specimens that often are air dried prior to further processing, a longer time is used, often approaching ten minutes.

An appropriate Cytospin 4 time will ensure fluid absorption. The cells on the slide should have a thin layer of fluid on their surfaces. Occasional specimens may be too thick to completely absorb in the filter paper during a normal time and speed setting. Such specimens may require special processing. An example is joint aspirations that contain hyaluronic acid, giving them a thick consistency. This can be reduced by adding a small amount of the enzyme hyaluronidase to the sample prior to operation of the cytocentrifuge

## Unloading the Sample Chambers

After the Cytospin 4 stops, the specimens should be removed as quickly as possible. The lid of the Cytospin 4 is opened, and the sealed head is removed and taken to the biological safety cabinet. The lid is opened, and the individual sample chamber assemblies are removed from the sealed head. The thumb pad release lever is pressed to open the slide support. The slide should be held horizontally on occasions where liquid remains, allowing any residual fluid to flood the slide. If there is a considerable amount of residual fluid, wait until some of it evaporates. However, do not allow the specimen to dry. Just before drying begins, place the slide in fixative, or spray with Thermo Scientific Cell-Fixx.

For specimens that do not contain excess fluid, quickly remove the sample chamber, remove the slide, and immediately place into fixative. (This is best achieved by easing the slide into the fixative, so as not to disturb the deposited cells).

## Evaluation of Specimen to Assess Technique

After staining, the specimens can be evaluated to assess the preparative technique. The ideal result is a monolayer of cells with minimal overlap, yet sufficiently concentrated that one does not have to search for cells in the preparation. The cells should display excellent morphology.

There should be no evidence of stretching, or tearing of the periphery of cells. Such artefacts indicate excessive speeds or times of Cytocentrifugation. In excellent preparations, there will be flattened nuclei with distinct chromatin patterns. Some cell types, such as columnar epithelial cells should retain their typical columnar morphology. Distortion of their columnar shape indicates excessive speed or time of

Cytocentrifugation. Occasionally one will see a specimen that has a pattern of cell deposition around the periphery of the deposition spot, with a loss of cells in the centre.

This effect is due to an excess amount of residual fluid in the centre of the cell deposition area when the specimen is fixed. Because the cells in the centre of the area are quite wet, they wash off the slide as it is immersed into the fixative. The solution to this problem is to allow longer time for the slide to dry prior to fixation, and to be exceptionally gentle during immersion of the slide into the fixative.

## Fixation

Fixation is used to preserve cell samples, to render them more easily stained, and to produce characteristic patterns of cell structure that are used to distinguish cell types. Cells continue their natural living processes after being removed from body sites. Since they no longer have their normal blood supply and other supporting environment, they will begin to degenerate as they run out of required nutrients and gases and begin to build up waste products. As these events continue, the cell activates internal repair mechanisms that eventually result in the cell digesting itself. This is called autolysis. The rate at which autolysis progresses is different for different cell types, but does mean that samples should be processed as quickly as possible. Autolysis can be slowed significantly by refrigeration, and samples may be held for some period of time at refrigerator temperature. Where practical however, specimens should be fixed or processed as soon as possible.

Fixatives are chemical agents that both kill the cell and stabilise its structure. The 'killing' also inactivates many of the enzyme systems of the cell, particularly those associated with autolysis. Fixatives therefore also function as preservatives, and well-fixed cytological samples essentially last indefinitely. Many specific chemicals can be used as fixatives, and each has specific properties that are desirable for certain types of study. These fixatives include those that produce chemical cross-links within the tissues, such as formalin, and those that precipitate cellular components such as the alcohols. By far the most common fixative used in cytological studies is alcohol. Alcohol produces distinct nuclear chromatin patterns, and also serves to remove water from the cells. Thermo Scientific Cell-Fixx spray fixative is an example of an alcohol based cytological fixative which also contains Carbowax.

A disadvantage of alcohol fixatives is that they evaporate quickly, and therefore there is always the risk of permitting specimens to dry out. To avoid this, many laboratories use Saccomanno fixative, which is a mixture of 70% ethyl alcohol and 2% Carbowax (polyethylene glycol). The Carbowax in this mixture forms a coating over the specimen, helping protect from the effects of drying. The Carbowax is soluble in water, and so is dissolved in subsequent staining steps. Commercial versions of this fixative are available (for example Thermo Scientific Cytospin Collection Fluid).

When specimens must be transported over considerable distances, or when they cannot be processed immediately, it is advisable to fix with alcohol or with Saccomanno type fixative. This is done by adding an equal volume of fixative to the sample. If the specimen is large in volume, the sample should be centrifuged to concentrate the cells, and then fixed. Immediately after adding the fixative to the sample, the sample should be vigorously agitated to suspend the sample within the fixative.

Occasionally samples will be received that have been fixed in some other fixative such as formalin. These will have a different nuclear and cytoplasmic appearance if processed without exposure to

alcohol. Such specimens can be concentrated, the formalin poured off, and then re-suspended in Thermo Scientific Cytospin Collection Fluid. The result will be a specimen that is reasonably similar to those fixed in the alcohol fixative alone.

Fixation makes cells more rigid and less able to spread when placed in the Thermo Scientific Cytospin. Specimens that have been fixed prior to depositing on slides will require slightly higher speeds and longer times to achieve the same degree of spreading as seen in unfixed specimens. Occasionally the laboratory will be asked to prepare specimens that have been held in fixative solutions for extended times. These specimens may be so rigid that it is difficult to get them to flatten on the slide. The addition of a small amount of glycerol to the specimen, allowing some 'soak' time, followed by use of the Thermo Scientific Cytospin, will usually result in a reasonable preparation.

Many laboratories prefer to fix all specimens during preparation. The usual protocol is to concentrate the specimen, then re-suspend in an equal volume of Thermo Scientific Cytospin Collection Fluid. For samples that must be diluted, the diluent can be fixative. These fixation steps are generally done just before adding the sample to the Thermo Scientific Cytospin sample chamber assemblies.

Whether the specimen has been fixed before deposition on slides or not, immediately after removing the slides from the Thermo Scientific Cytospin, they should be immersed in 95% alcohol to complete fixation and dehydration. Since the cells will still be wet, and will not have become totally bound to the glass slide, use care in this transfer. (Ease the slide into the fixative in the container). Many complaints of poor cell capture can be traced to lack of care in this step of the procedure.



## Special Considerations

### Cell Adhesion

Successful application of the Cytospin 4 requires that cells adhere to the glass slides. For many routine applications, it is sufficient to use clean slides. Slides may be cleaned using alcohol. The increasing use of long staining techniques, such as immunostaining, may require additional ways to ensure adhesion of samples. The use of coated slides will increase cell retention and reduce the incidence of 'floaters' in the subsequent staining baths.

### Cytology

The majority of the procedures previously discussed apply to cytological specimens. However, there are a number of specific specimen types that require special processing. Often, the cytology specimen will contain clots, fibrin webs, or tissue fragments. These will all interfere with the Cytospin 4 preparations. Small floating clots and fragments should be removed with forceps. These may be saved for cell block procedures. Fibrin webs are generally too friable to be removed intact. These are most easily removed by twirling a glass or wooden rod in the specimen.

The fibrin web is wound onto the rod, and in the process, many of the trapped cells will float free. After winding on the fibrin, it is pressed gently against the side of the container to squeeze out as much of the trapped fluid and cells as possible. As with all cell manipulation techniques, it is important to be gentle to avoid excessive cell damage.

Cytological samples may contain considerable quantities of mucus. This is a very thick mass that is difficult to dilute or concentrate, and becomes a rubbery mass on fixation. Such specimens should be processed prior to fixation. A common way to break up mucus is to mix with an equal part of Saccomanno-type fixative (for example Thermo Scientific Cytospin Collection Fluid) and immediately blend in a small blender. Three to five seconds is usually sufficient.

The blending procedure should be done in a biological safety cabinet. After blending, the sample should be homogenous and non-stringy, and can be deposited using the Cytospin 4. Certain chemicals also react with mucus to produce liquefaction, such as acetylcysteine (Boccatto, 1981). A commercial product of this type is Thermo Scientific Mucollex, which contains not only a mucolytic agent but Saccomannotype fixative as well.

Bloody or serosanguineous specimens may contain so many erythrocytes that examination of cytological preparations is difficult, and when the specimen is diluted sufficiently to obtain monolayer preparations, the cells of interest are difficult to locate. Red blood cells may be removed by gradient centrifugation or by various lysing procedures. Lysing techniques are commonly used for leukocyte counting on cell counters that employ sensing orifices. CytoRich Red collection fluid completely destroys erythrocytes. The large amounts of haemoglobin released from the red cells may interfere with subsequent staining. It can be removed by several washing steps using a conventional centrifuge.

Gradient centrifugation is based on a density difference between red cells and other cells within a specimen. Commercial gradients are available, and are based on mixtures of Ficoll and Hypaque. The

sample is layered onto the gradient in a centrifuge tube and then the tube is centrifuged. The red cells will migrate through the gradient, and will also be haemolyzed. The remaining cells will stay on top of the gradient, and can be removed for subsequent processing.

## Haematology

The primary difference between cytological and haematological preparations is the routine use of air dried preparations in haematology. In most cases, haematology will also have available a specific cell count derived from an electronic volume sensing instrument. This permits a defined solution and allows precise control of cell number on the final Cytospin 4 preparation.

Haematological samples are routinely diluted to obtain samples of the correct cell concentration. The diluent used is commonly one of the balanced salt solutions. Thermo Fisher Scientific recommends that coated slides are used to increase adhesion of the cells to the slide, and to avoid the deleterious effects of the high concentration as the diluent evaporates during the drying of the slide.

Since haematology specimens are to be air dried, they should not be flooded with any residual liquid after use of the Cytospin 4. For haematology, after the chambers are removed from the Cytospin 4 sealed head, any residual fluid is allowed to drain back into the sample chamber. The thumb pad release lever is then pressed to open the slide support and remove the slide. The disposable cytochamber is properly discarded following laboratory safety procedures. The slide is then air dried. As with all air dried preparations, the more rapidly drying occurs, the better. Drying may be accelerated by gentle heating of the slides.

## Urine Specimens

Specimens derived from urine are typically high volume fluids with few cells or particles. These specimens must be concentrated by conventional centrifugation prior to cytological examination. If appropriate, a Thermo Scientific EZ Megafunnel can be used. Often urine samples contain particles that are not cellular but are precipitated phosphate salts. It is often suggested that one can dissolve these particles by acidifying the specimen with a few drops of acetic acid.

While this will cause the salts to dissolve, acetic acid is also a classic fixative. It will cause chromatin condensation in the cell nuclei, and will also produce significant cell swelling. Acetic acid is a component of Carnoy's fixative. If acetic acid is used, its effects must be accounted for in subsequent evaluation of the specimen.

## Microbiology

Many microbiology samples are quite similar to cytological samples. They will contain cells and the microbiologist is interested in the association of bacteria or viruses with the cells. The Cytospin 4 can also be used to directly deposit samples of bacteria onto slides. The advantages of this use is that the deposited bacteria are generally more concentrated than after simple smearing, and they are all located in a defined area of the slide. Due to the small size of the bacteria, the Cytospin 4 is generally operated at speeds of 2000 rpm for five to ten minutes with high acceleration.

Many of the techniques used for localisation of viruses or bacteria require the use of fixatives other than alcohol based ones. In general, techniques using immunostaining or nucleic acid probes will specify the use of aldehyde fixation, such as formaldehyde (paraformaldehyde) or gluteraldehyde. These do not affect the operation of the Cytospin 4, since they are applied to the slide after the cells, bacteria, or viruses are deposited on the slide. It is important to use slide adhesive or preferably coated slides for these preparations.

## The use of the Thermo Scientific Cytospin 4 for Haematology and other clinical Microscopy Specimens

These guidelines outlining the Use of the Cytospin 4 for Haematology and other Clinical Microscopy Specimens have been prepared by:

Nicky Sherwood, MT (ASCP) and Joanne Cornbleet (MD),  
 Clinical Haematology Laboratory,  
 Stanford University Medical Centre

### Introduction

This section is designed to provide general guidelines for the use of the Cytospin 4 in haematology and clinical microscopy.

### Uses and Application

The Cytospin 4 has a wide range of applications in clinical microscopy, some of which are shown below.

Uses	Clinical Applications
Romanowsky-stained cytology of CSF and other body fluids	Evaluation of possible infection or presence of malignancy
Gram stain and other special stains of CSF and body fluids	Detection of infectious agents - characterization of malignant cells
Slide preparation from ficoll-hypaque cell isolates	Provides slides for morphology, cytochemical staining (e.g. myeloperoxidase, non-specific esterase), and immunocytochemical or immunofluorescent assays (e.g. TdT). Used to characterize leukemias and lymphomas
Cell surface and cytoplasmic marker studies using monoclonal antibodies	Classification of leukemias and lymphomas
Urine eosinophils	Evaluation of drug-induced nephritis, allergic cystitis, and renal transplant rejection
Urine hemosiderin	Confirmation of severe intravascular hemolysis and chronic iron overload

## Methodology Guidelines

When first setting up the Cytospin 4 for use, it is helpful to establish a standard procedure, i.e. the amount of specimen per slide, rpm and minutes centrifuged and maximum number of white blood cells per litre and red blood cells per litre, above which dilutions would be necessary.

1. Determine the red cell and white cell count of the sample according to established methods.
2. Using a 'standard' amount of specimen, (e.g. 5 drops or approximately 0.25 ml) makes serial dilutions of a highly cellular specimen to determine the maximum number of white blood cells and red blood cells that can be present in a specimen before dilutions are necessary. Some tests may require more cellular slides than others.
3. Experiment with a range of speeds to see which gives the most desirable morphology for the procedure involved. Establish the minimum number of minutes required to spin the entire standard amount of specimen onto the slide.
4. The following is an example of a standard procedure for preparing slides for a white cell differential with Wright stain:

Use 5 drops of specimen per Cytospin 4 chamber. Dilute sample to obtain a white cell count less than  $0.5 \times 10^9 / l$  and a red cell count less than  $0.005 \times 10^{12} / l$ . Centrifuge at 700 rpm for 5 minutes with medium acceleration.

WBC Count (x 10 <sup>9</sup> / litre)	Dilution
0 - 0.05	None
0.05 - 0.1	1/2
0.1 - 0.15	1/3
0.15 - 0.2	1/4
0.2 - 0.25	1/5
0.25 - 0.3	1/6

If the red cell count which results from the above WBC dilution is greater than  $0.005 \times 10^{12} / l$ , calculate the further dilution necessary to bring the red cell count below  $0.005 \times 10^{12} / l$ . Use this dilution regardless of the fact that the white cell count may be very low.

5. Use a disposable EZ Single Cytofunnel.
6. Always place the EZ Cytofunnel assembly into the Cytospin 4 head before adding anything to the sample chamber. Check that the assembly pivots freely in the metal support plate.
7. Use coated slides to increase the adhesion of the cells to the slides. Cap the sample chambers.
8. Lock the lid onto the sealed head, transfer the sealed head to the Cytospin 4, and close the lid. Never snap the lid of the Cytospin 4 head down onto the bowl while the assembly is sitting on the drive shaft, as this may damage the shaft.
9. Program the Cytospin 4 to the standard number of rpm and minutes and start the unit. Fragile cells may require a lower rpm setting and low acceleration to maintain morphology.
10. When the 'End of Run' tune has ended, remove the sealed head and transfer it to a hood before opening.

11. Check the sample chambers to see if the entire specimen has spun onto the slide. Make sure that any remaining specimen in the chamber does not flow onto the slide as it is removed from the assembly. Should this occur, the cells will not remain spread out on the slide and may therefore over-stain.

### **Suggestions for Optimal Thermo Scientific Cytospin 4 Technique**

1. Use coated slides.
2. Do not make a push smear, even when the cell counts are high. Large malignant cells are difficult to identify on push smears because they may aggregate at the feather edge or stain darkly in the thick portion of the smear.
3. Use a disposable EZ Cytofunnel and do not let any un-spun specimen wet the slide.
4. If fibrin strands or other contaminated materials are present, they may clog the filter card and prevent absorption of the specimen. Better slides may sometimes be obtained if an aliquot of the specimen is first diluted in saline, centrifuged, and then the cells are re-suspended in saline to the original volume.
5. If synovial fluid is extremely viscous, a small amount of hyaluronidase may be added to liquefy the sample before processing.
6. If a fluid is clotted, Cytospin 4 slides may be prepared from a suspension of the clotted material as well as from the un-clotted fluid to increase the possibility of detecting malignant cells.

## Appendix C – Transportation Instructions

If you ever need to transport the Cytospin 4 cytocentrifuge, the following packaging instructions should be followed.

### Repacking

#### Note

*If the Cytospin 4 (and sealed head) is to be serviced or returned to Thermo Fisher Scientific, they must be thoroughly cleaned and decontaminated.*

- Press the O (OFF) side of the mains power switch to switch the mains power switch off.
- Disconnect the mains cable from the mains supply and the Power Supply Unit.
- Place the sealed head into the instrument.



- Fit the circular foam packing piece onto the top of the sealed head lid.



- Close the Cytospin 4 lid. Make sure that the lid is secure.
- Place the Operator Guide into the packing box and place the instrument on top of it.

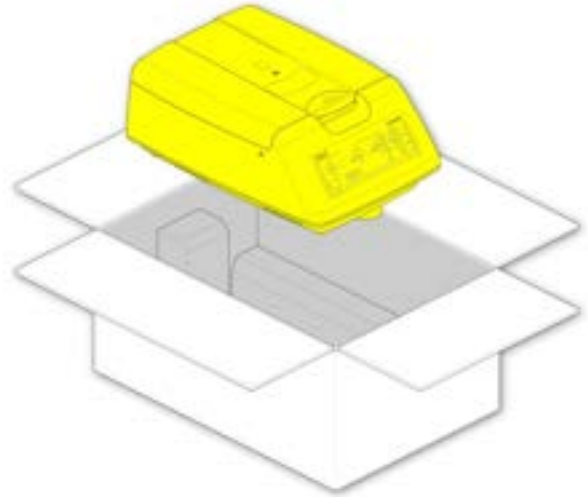

- Lay the inner foam packaging onto the instrument inside the box.

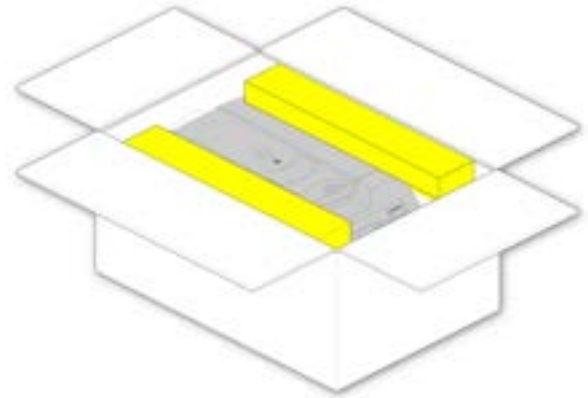

- Put the mains lead with the pen and manual release tool into the smaller box and place this box in the front of the main box.

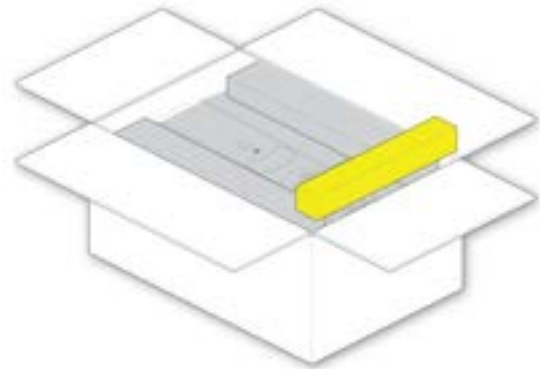

Close and seal the box



## Appendix D – Approved Reagent List

This Section lists all the reagents that Thermo Fisher Scientific specify can be used with the Cytospin 4 cytocentrifuge.

If you want to use a reagent not included in this list, contact your Thermo Fisher Scientific agent for advice.



**Always refer to the material Safety Data Sheet (MSDS) for the reagents used**

### Reagent List

- Industrial Methylated Spirits (IMS) / Reagent alcohol (up to 5% methanol in ethanol)
- Isopropyl Alcohol (IPA)
- Ethanol
- Cytospin® Collection Fluid
- Mucolexx® Transport Fluid
- CytoRich® Red Collection Fluid
- Formal-fixx™
- Cytoblock® reagents
- Papsin

### Cleaning Agents

- General purpose household or commercial detergent (diluted in accordance with the manufacturer's instructions)
- Sodium Hypochlorite 10% (10% commercial bleach)
- Most proprietary disinfectants in common laboratory use, such as Clorox®, or commercial disinfectants diluted with 0.3% bicarbonate buffer at 7.0 to 8.0 pH, should be suitable (always test a small hidden area of the instrument case first)
- Water



**Do not use Xylene, Toluene or similar solvent**



**Do not use detergents that are unsuitable for use on nonferrous metals (for example Decon 90) on the sealed head assembly**

# Index

---

## A

Accessories .....	23
Appendices .....	60
Appendix A – Standard Workflow Diagram .....	60
Appendix B – Methodology Guidelines.....	62
Appendix D – Approved Reagent List.....	79
Approved Reagent List	
Cleaning Agents .....	79
Reagent List.....	79
Approved Reagents.....	14

---

## C

Cells / 40x field as a guideline to the number of drops of cell suspension / Thermo Scientific Cytospin 4 sample chamber .....	65
Chemical Safety .....	7
Cleaning and Maintenance .....	44
Routine Cleaning and Maintenance.....	45
Company Information.....	3
Cone Seal .....	48
Control Keypad .....	31
Controls .....	28
Main Control Panel .....	28

---

## E

Electrical Requirements .....	21
Electrical Specification .....	15
EMC Statement.....	4
Entering the Acceleration Required.....	42
Entering the Speed Required .....	41
Entering the Time Required .....	41
Environment .....	7
Environmental Specifications .....	15
Error Codes, Audible Tones and Warnings .....	43
EZ Double Cytofunnel .....	25
EZ Megafunnel .....	26
EZ Megafunnel End of Spin Processing Run .....	27
EZ Single Cytofunnel .....	23

---

## F

Front Panel.....	45
------------------	----

---

## G

General Safety.....	5
General Theory – General laboratory Considerations ..	62
General Theory – Introduction.....	62

---

## H

Haematology and other clinical Microscopy Specimens .....	74
---	----

---

## I

Installation and Setup .....	16
Instrument Function	
Error Codes .....	50
Introduction .....	74
Introduction to the Cytospin 4	
Description .....	13
Introduction to the Thermo Scientific Cytospin 4	
System Specifications.....	15
Introduction to Thermo Scientific Cytospin 4 .....	13
IVD Intended Use .....	13

---

## L

Lid Seal .....	49
Lid, Case, Plinth and Bowl Liner .....	45
Loading the EZ Cytofunnel .....	37
Loading the Sealed Head.....	38

---

## M

Mechanical Specification .....	15
Method of Operation .....	33
Methodology Guidelines.....	75

---

## O

Opening and Closing the Cytospin 4 Lid.....	18
Opening and Closing the Sealed Head .....	19
Operation	
Loading the Cytospin 4.....	37
Operating the Thermo Scientific Cytospin 4 .....	35
Optimal Thermo Scientific Cytospin 4 Technique .....	76

---

**P**

Program Details .....	15
Program Keypad .....	28

---

**S**

Safety Information .....	5
Saving a Program .....	40
Seal Replacement .....	48
Sealed Head Assembly .....	46
Sealed Head Base .....	46
Sealed Head Lid .....	47
Selecting a Program .....	40
Siwtch Convention .....	15
Sound Power level .....	15
Spares and Accessories .....	58
Special Considerations .....	71
Cell Adhesion .....	71
Cytology .....	71
Haematology .....	72
Microbiology .....	72
Urine Specimens .....	72
Specimen Preparation .....	63
Determination of Cell Number .....	64
Evaluation of Specimen to Assess Technique .....	69
Fixation .....	69
Initial Examination .....	63
Loading the Thermo Scientific Cytospin 4 Sample Chambers .....	67
Selecting Time, Speed and Acceleration .....	68
Specimen Dilution .....	67
Specimen Enrichment .....	66
Unloading the Sample Chambers .....	68

Starting a Run .....	42
Status Display .....	32
Support Plate .....	47
Switching On and Off .....	22
Symbols .....	6

---

**T**

Table 2 – Error Codes .....	51
Table 3 - Unsatisfactory Cytocentrifugation Results – Quality .....	52
Table 4 - Unsatisfactory Cytocentrifugation Results – Quality (Number of Cells) .....	54
Table 5 – Unusual Pattern of Cell Population Distribution .....	55
Table 6 – Summary .....	56
To Switch Off .....	22
To Switch On .....	22
Transportation Instructions .....	77
Repacking .....	77
Troubleshooting .....	50
Instrument Function .....	50

---

**U**

Unloading the Thermo Scientific Cytospin 4 .....	42
Unpacking .....	17
Uses and Application .....	74

---

**W**

Warranty Statement .....	7
--------------------------	---